

**Guide
to Your
Yamaha
Electone
B-5CR**

 **YAMAHA**

Contents

	Page
Introduction	1
This is Your Yamaha Electone B-5CR	2
Keyboards	4
The Compass of the Electone B-5CR	5
Tone Levers	6
Effect Levers	9
Effect Controls	10
Sound-in-Motion Tremolo	11
Auto Rhythm Section	12
Various Rhythms and Their Use	14
Playing The Yamaha Electone	20
Let's Learn to Read Music	21
Let's Play Accompaniment	22
To Fully Enjoy Your Electone	24
Care of Your Electone	25
Do not Be Alarmed If	26
Specifications	28

Introduction

Congratulations upon your selection of this Yamaha Electone. It is one of the world's most advanced musical instruments, carefully designed and built to provide a lifetime of musical enjoyment.

To make sure you derive the most from its generous features and durable IC & FET circuitry, please read this manual thoroughly before attempting to play. Then keep it handy for reference. Use it to develop your own techniques and to teach others. With a little care your Electone will become a creative center of family enjoyment for decades.



This is Your Yamaha Electone



B-5CR

Electone B-5CR

Power Switch **L**

- 1** Wood 8'
- 2** Horn 8'
- 3** Cello 8'
- 4** Vibrato
- 5** Percussive Length
- 6** Percussive 4'
- 7** Flute 16'
- 8** Trombone 16'
- 9** Flute 8'
- 10** Oboe 8'
- 11** String 8'
- 12** Flute 4'



- 13** Auto Rhythm Section
- 14** Pedal Sustain
- 15** Bass 16'
- 16** Bass 8'
- 17** Reverb
- 18** Reverb Balance
- 19** Tremolo Selectors
- 20** Pilot Lamp

Keyboards

The B-5CR has three keyboards. The upper two are called "manuals" and the other, for the feet, composed of "pedals."

Upper Manual	44 keys
Lower Manual	44 keys
Pedals	13 pedals

The Electone is designed to permit playing the melody on the upper manual with the right hand, the chords on the lower manual with the other, and bass notes on the pedals with either foot.

All keys and pedals are arranged in the traditional keyboard method: two black keys, three black keys. Each white key has a name (from A to G), and the blacks are sharps or flats. "C" is always the white key just below the left black key in the two-black-key group. Any complete set of seven white keys and five black keys is called an "octave."

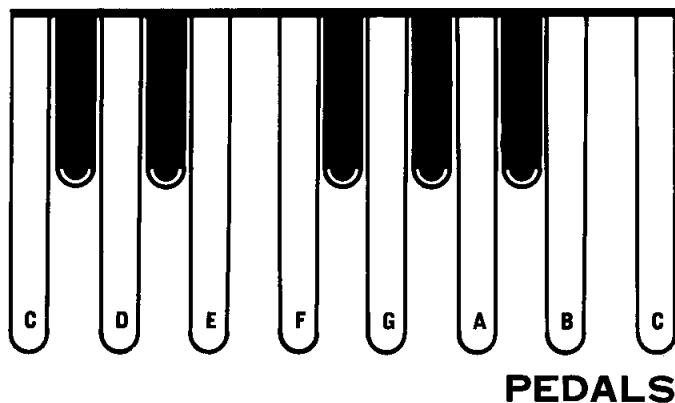
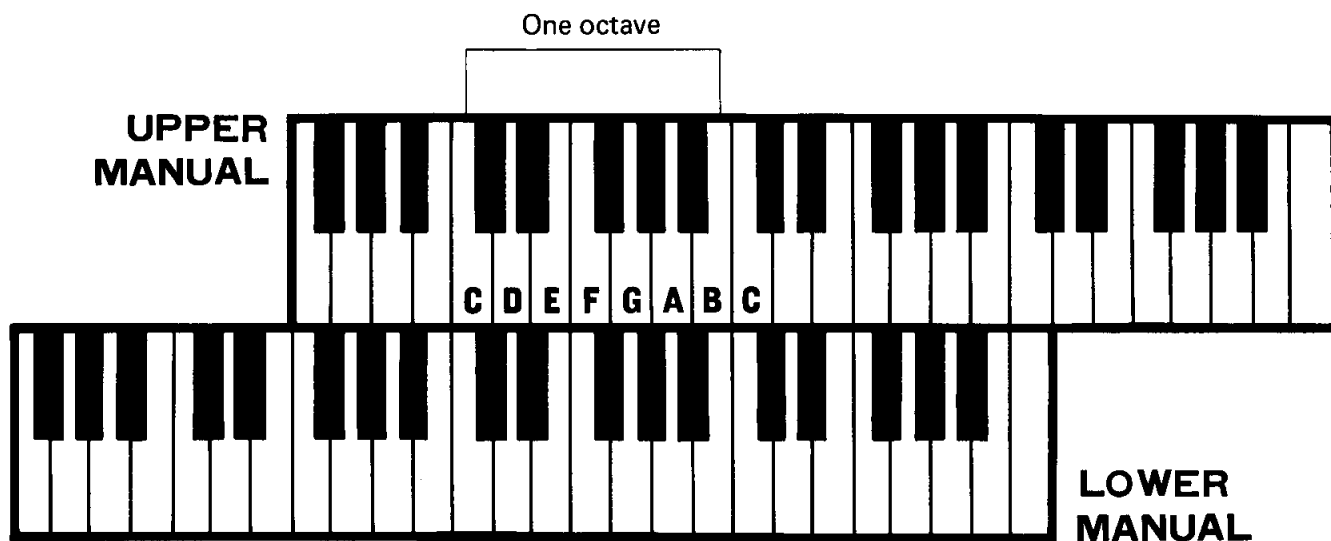

The Compass of the Electone B-5CR

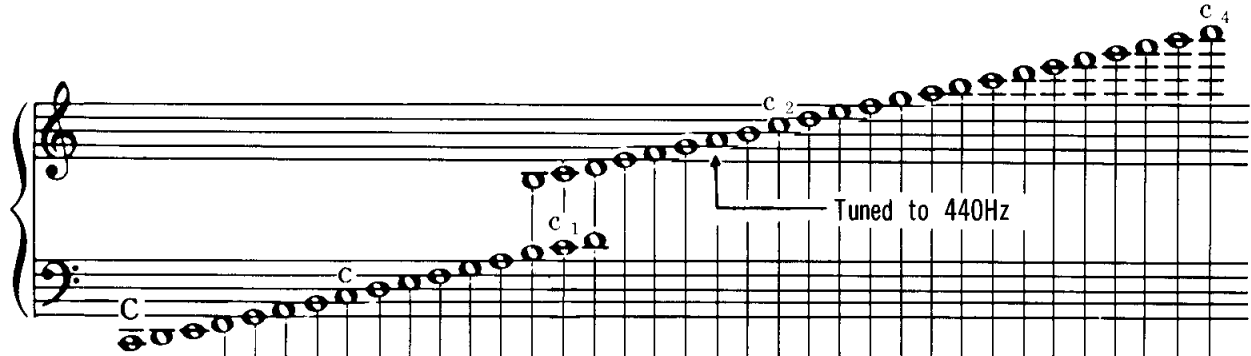

Upper Manual



Lower Manual

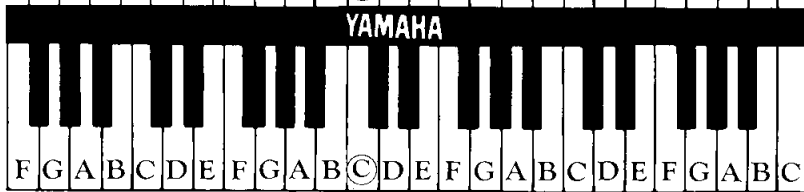

Pedals

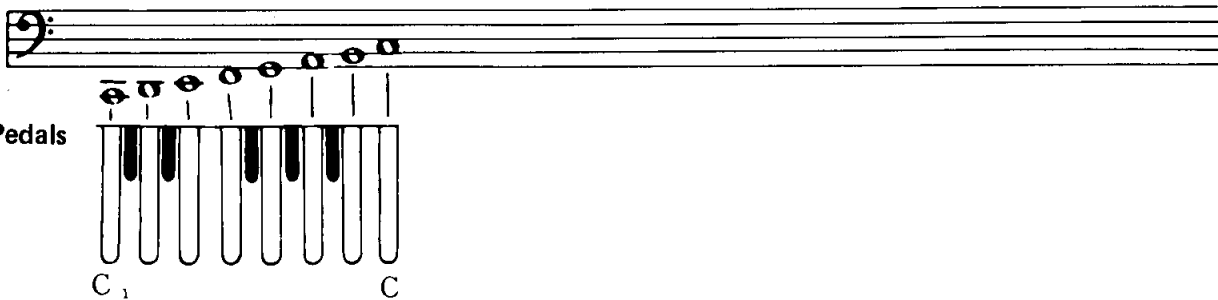

Tone Levers

To the left of both upper and lower manuals are a series of tone levers which control the voices (instrument sounds) which will sound when the keys are depressed. They are divided into groups for upper, lower and pedals, so that different registrations can be set for each.

Upper Manual Levers	6 voices
Lower Manual Levers	3 voices
Pedal Levers	2 voices

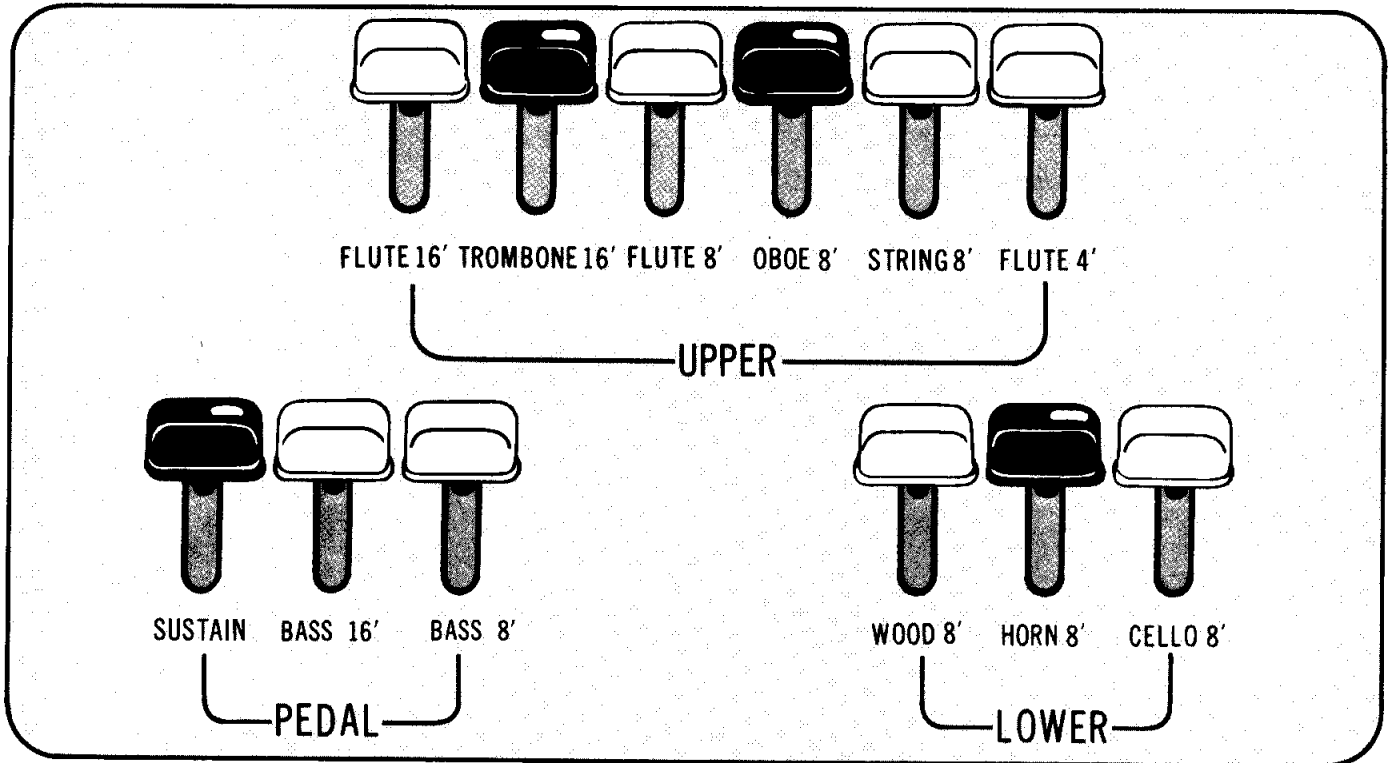

Tone Lever System

Each lever provides two methods of control. One is by continuously moving the lever from off to full, to achieve the exact setting for that tone, and thus balancing the overall tone setting with perfect precision. Each lever also has two easy-to-feel click stops, at 1/3 and 2/3 positions. This lets you refine any setting with mathematical precision and no guesswork in a matter of seconds.

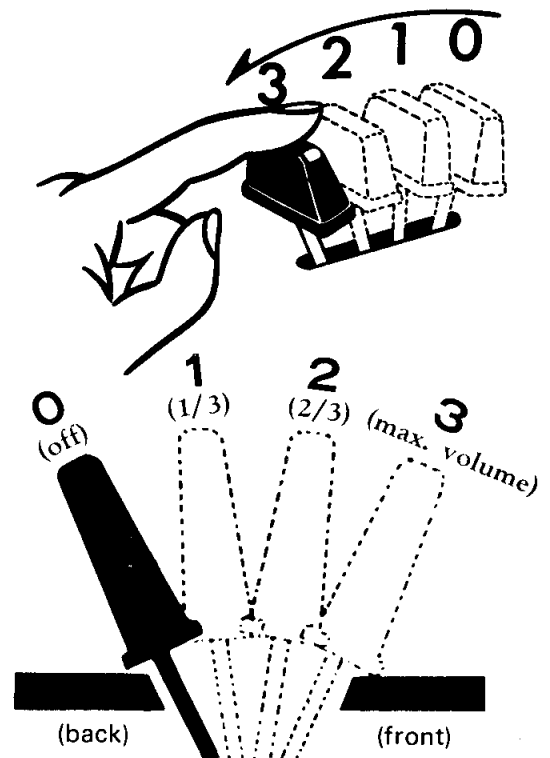

Pitches or Footages

The B-5CR has three different pitch levels, indicated by the numbers 16', 8' and 4'. These are standard organ abbreviations showing the tone's pitch in relation to the fundamental (written note). An 8' tone will sound just as it has been written. A 16' tone (meaning that the wave length of the vibrations are twice as long as 8', or half as fast) will provide a tone exactly one octave lower than the written note. Similarly, 4' tones are one octave higher than the written note.

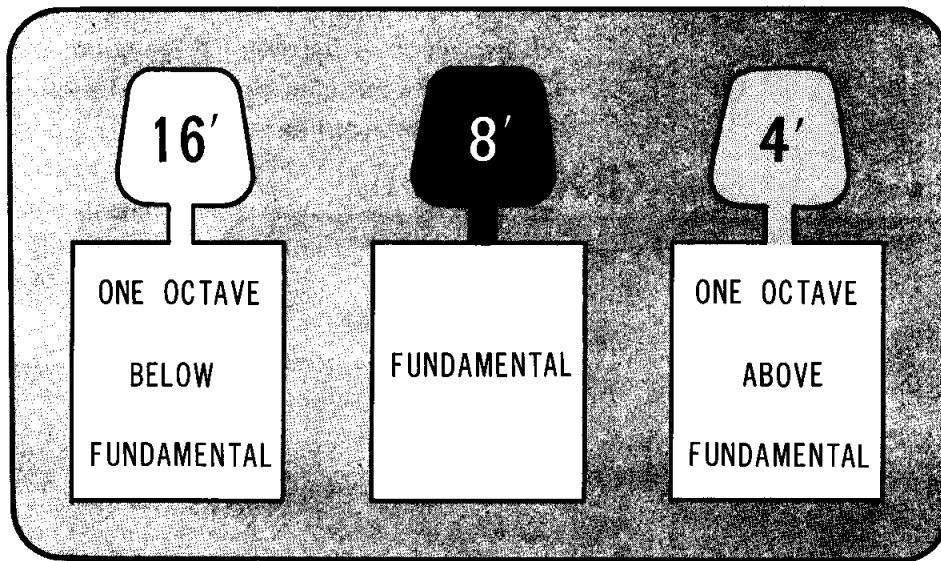

For example, if you press middle C, sound will be produced corresponding to the keys in the chart below.

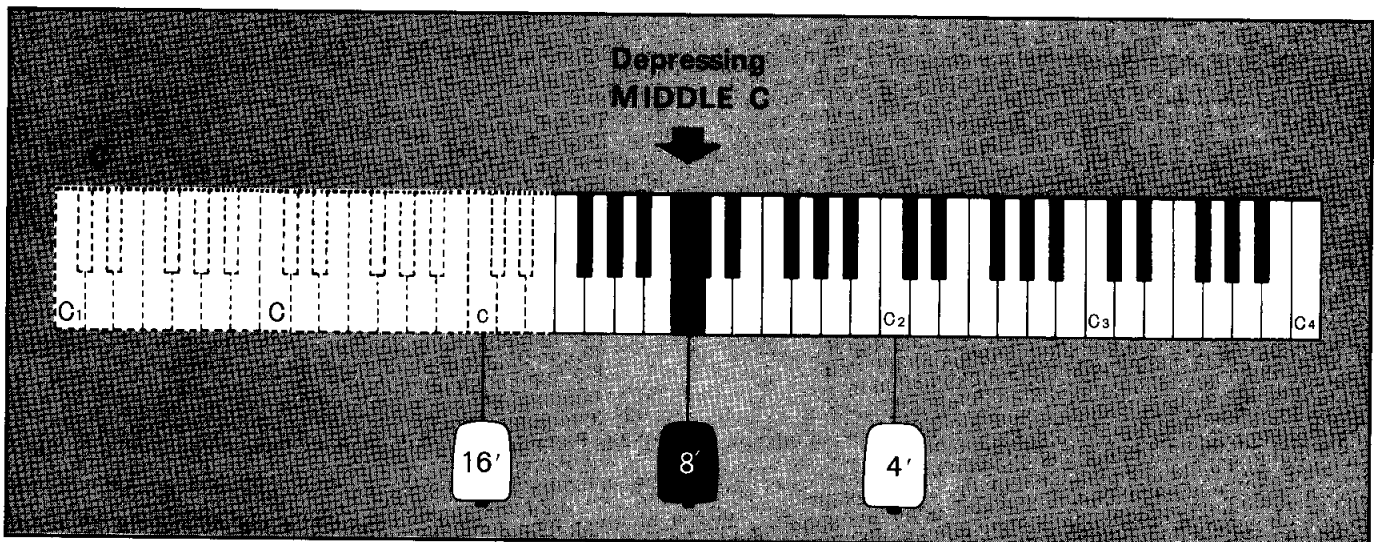

Tone Lever Registration

For best performance, you should always take into consideration the relative tone volume balance among the three keyboards i.e., upper manual, lower manual and pedals.

When you wish to emphasize the melody played on the upper manual, for example, the volume of the lower manual and pedals should be kept under that of the upper manual. On the contrary, if you want to stress the accompaniment part on the lower manual or pedals, the volume of that particular keyboard should be adjusted relatively louder than the others.

Yamaha's unique variable tone levers you control this relative tone volume among three keyboards. Judge by your own ears and adjust the position of the levers in advance.

● UPPER

(EXAMPLE)

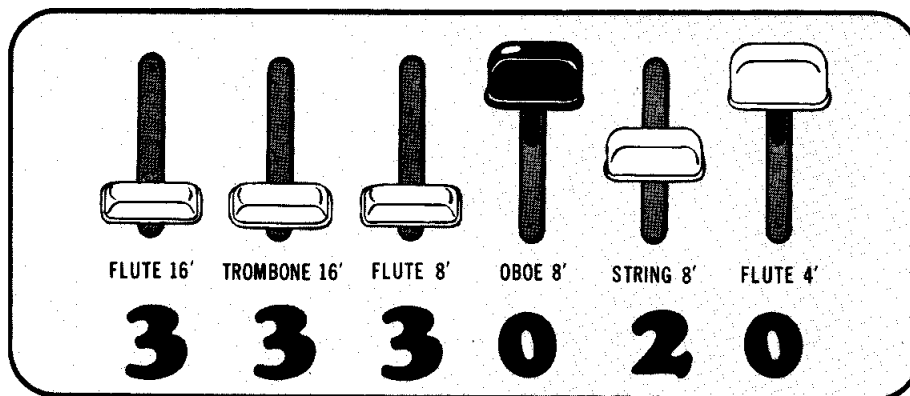

● LOWER

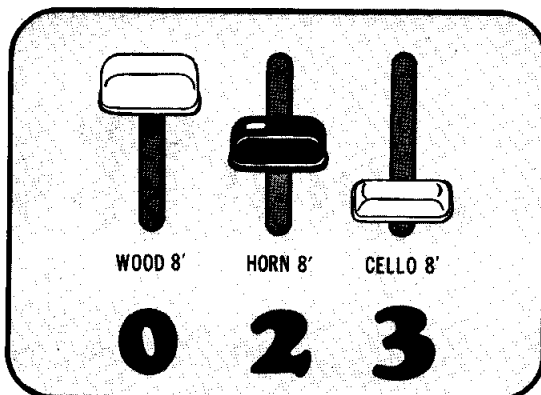

● PEDALS

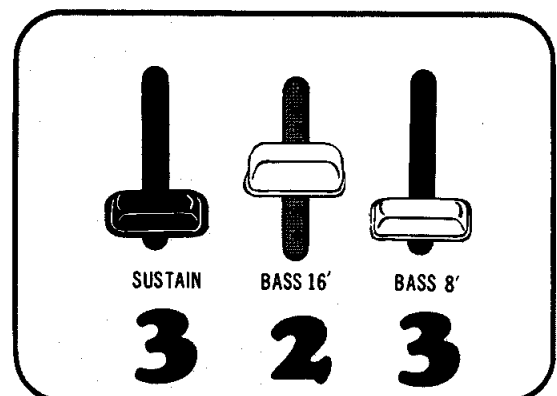

Effect Levers

These levers control a variety of effects which add a host of tonal variations to the Electone's voices. Each lever works in the same way as the tone levers, with both infinitely-variable continuous control and click-stop settings.

● Upper Percussive ⑤ ⑥

Changing the beginning of some or all notes can do wonders for lively selections. Your Electone's percussive effects provide subtle but important shading at the moment each note is heard. The special popping 4' percussive drive can be smoothly blended into all upper manual tones with a single variable lever ⑥, and a separate lever ⑤ regulates the length of decay for this effect.

With percussive, use a detached fingering. Each note should be played cleanly; slurred notes will diminish the percussive impact.

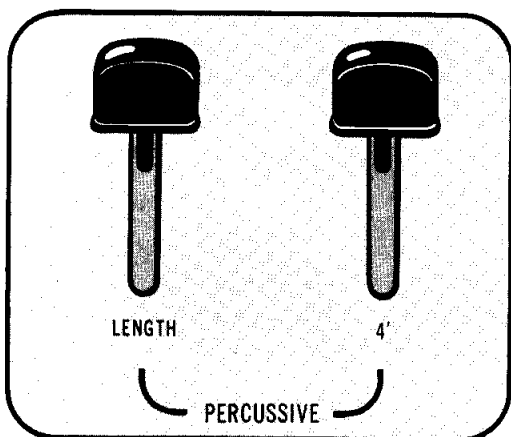

● Vibrato ④

Vibrato is a waving of the tone. You will see violin and cello players use it freely by an oscillating motion of the left hand. It increases the emotional quality of the violin tone. This vibrato lever produces the same vibrato effect.

● Pedal Sustain ⑬

This control provides continuous adjustment of the sustain effect on the pedals. For the pedals, this is the only sustain control, and it affects all pedal tones.

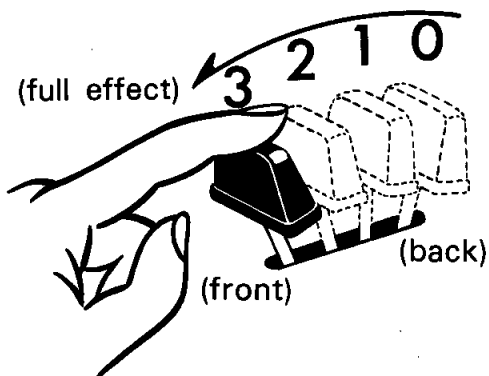

Effect Controls

Tone Lever Registration

For best performance, you should always register the tone lever by pulling it down to the "OFF" position. This will ensure that the tone lever is properly registered and that the tone lever is not in the "ON" position when you start playing. This will prevent the tone lever from being in the "ON" position when you start playing, which will cause the tone lever to be in the "ON" position when you start playing.

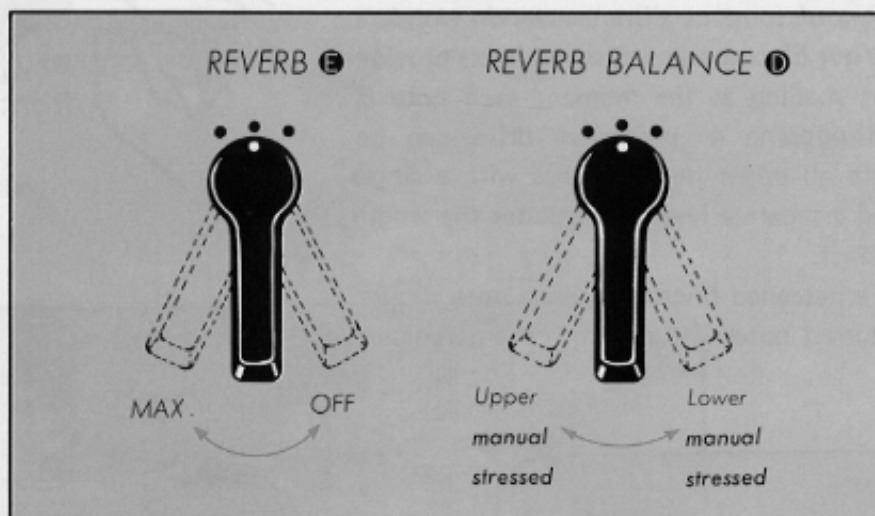

● Reverb ②

Reverberation is the quality that makes your playing sound full and rich, as if you were on the stage of a large hall or auditorium. This control is continuous, so that the reverberatory effect can be set to any degree of strength, as the music requires.

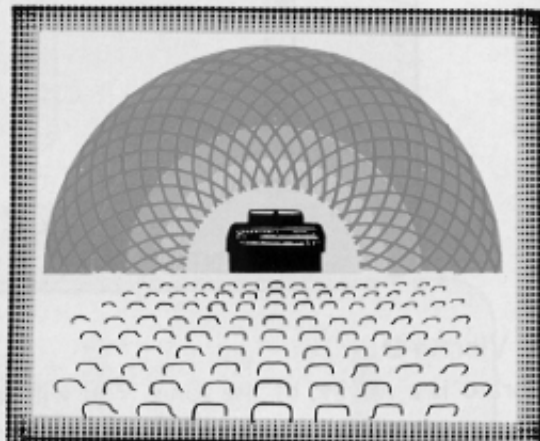

● Reverb Balance ①

To balance the Reverb effect between the upper and lower manuals; when used to strengthen the upper manual, it brings you an effect similar to SUSTAIN on more expensive models.

Sound-in-Motion Tremolo

The Electone's special throbbing tremolo is produced by a smaller-size Natural Sound speaker that actually spins just behind the tremolo speaker grille on the side of the cabinet.

On the B-5CR there are three tremolo selectors, located on the right side of the lower manual. They are complemented by a continuous tremolo speed control knob just above them.

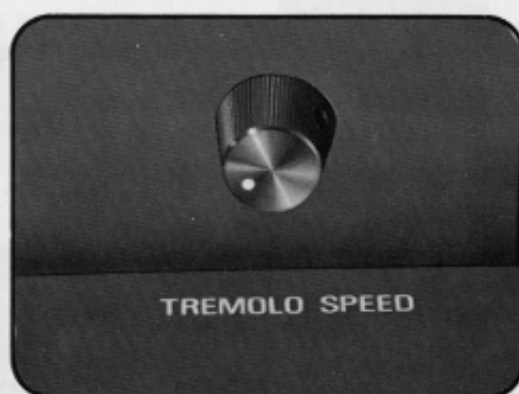

When the speed control is set to its maximum position, the Tremolo tablet will turn the speaker at seven revolutions per second. The Chorus tablet will turn it at one revolution per second.

Once either tablet is switched on, it takes several seconds for the tremolo speaker to attain the standard speed. This is also true when switching to a slower speed (Tremolo to Chorus). If one of the other tremolo control tablets is switched on during this speed change period, the speed variation will be heard in the music.

If you wish an instant tremolo or chorus sound, be sure to switch on that tablet well in advance of the speaker selector. For special selections you can use this speed variation by switching the speaker on first, the Tremolo or Chorus switch later.

● Voice (Main/Tremolo)

Lets you divert the sound from the main to the tremolo speaker.

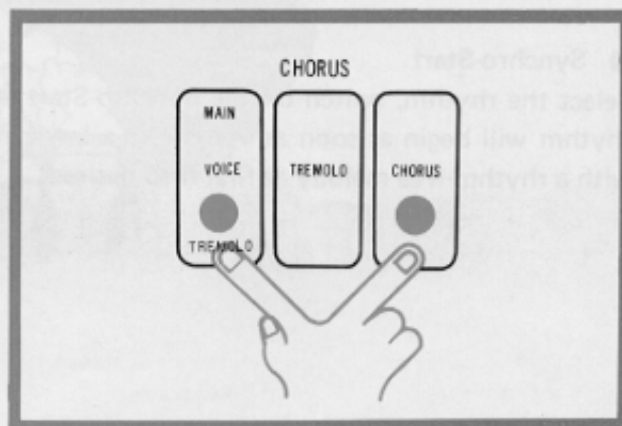
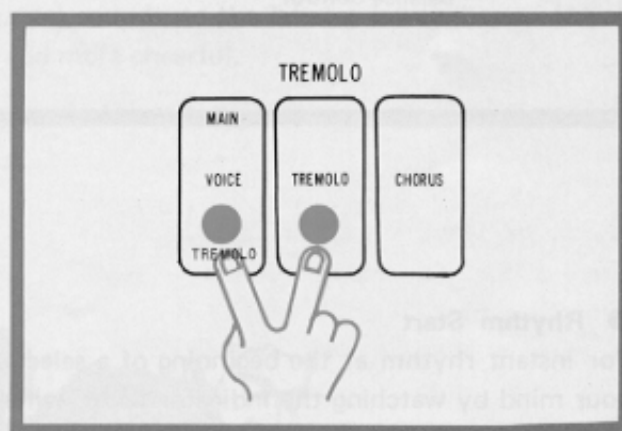

Auto Rhythm Section

This section provides eight catchy rhythms, each one called forth by a simple button. In addition to a combined volume and balance knob, tempo control and tempo indicator light, there are two other switches: ordinary Start and the Yamaha Synchro-Start which begins the rhythm accompaniment on the first beat of a measure when the first lower manual or pedal note is struck. A foot switch fitted on the expression pedal lets you cut and restart the rhythm at any point during play.

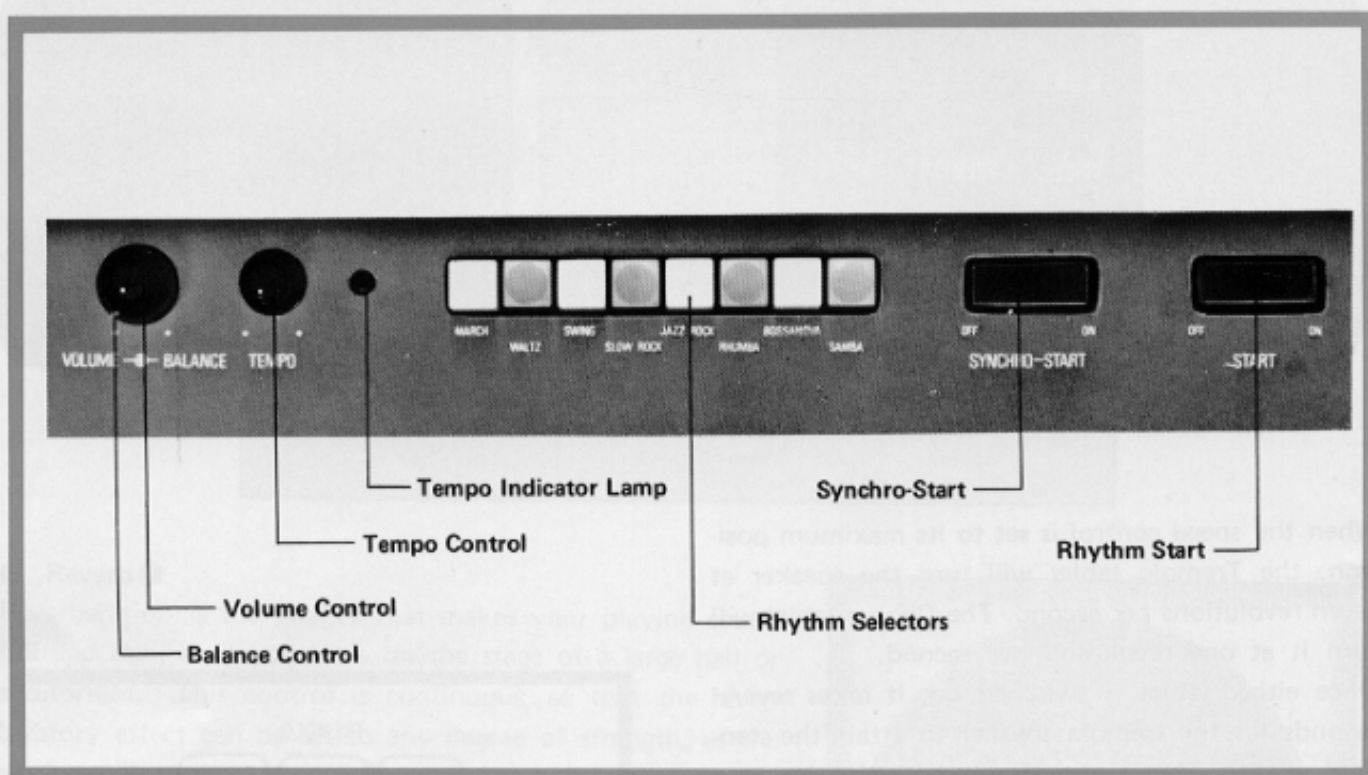

● Rhythm Start

For instant rhythm at the beginning of a selection. Push the rhythm selector desired, get the beat set in your mind by watching the indicator lamp, (when the Synchro-Start switch is on) and then turn the Start switch on.

● Synchro-Start

Select the rhythm, switch on the Synchro-Start and begin to play once you have the beat established. The rhythm will begin as soon as you strike a lower manual or pedal note. This switch permits you to lead in with a rhythm-free melody at first if so desired.

● Rhythm Stop (Foot Switch) ①

This switch is located in the expression pedal housing to the left of the pedal. Once the rhythm is on, push this switch once to instantly stop it, once again to restart. It lets you stop and restart the rhythm in the middle of a selection without using your hand.

Note : After the foot switch has been used, be sure it is reset to normal after you finish playing your selection, and then make sure both Start and Synchro-Start switches are off. Otherwise you may turn on one of the switches in the middle of a new number only to find the rhythm still canceled.

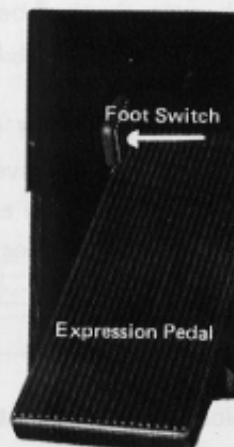

● Tempo Control

The tempo of the Auto Rhythm section can be adjusted by a continuous control knob. This is best accomplished by turning on the Synchro-Start switch. Although no sound will be produced, the indicator lamp will flash each quarter note, letting you visually check the tempo while you adjust.

● Volume Control

Use it to balance the volume of the rhythm section and the manuals. This volume is then varied during the selection by the expression pedal, just like that of the other tones.

● Balance Control

This control lets you balance the low rhythm sounds, such as drums, and the high sounds (i.e. cymbals) according to your mood and the selection. It can make a big difference even when using the same rhythm. Turn the knob to the right to accentuate the higher (treble) sounds, to the left for lower (bass). If you accentuate the treble sounds the rhythm becomes brighter and more cheerful.

Check the playing hints for specific settings.



Various Rhythms & Their Use

Each auto rhythm beat includes some or all of the following sounds: long and short cymbals, bass drum, snare drum, rim shot, high and low conga, high bongo.

Successful timing of the rhythm and use of the proper beat for each selection will add to your musical pleasure. The creative variations employing auto rhythms are virtually endless, so wide experimentation is recommended. The examples given below are only to help you get started. They are divided according to the eight different beats.

1. March

Basically a 2/2 beat, it nevertheless blends well with 4/4 selections.

Examples :

- March Theme from Bridge on the River Kwai
- Clarinet Polka
- I Could Have Danced All Night
- American Patrol
- You Are My Sunshine

Balance Adjustment

If the snare drum sound on the second and fourth beat bothers you, set the balance higher (to the right) to brighten the overall rhythm sounds.

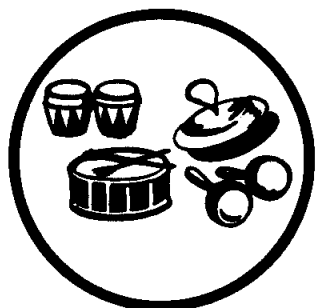

Rhythm	Instruments	Rhythm Pattern							
MARCH	Cymbal 1	♪	♩	♪	♩	♪	♩	♪	♩
	Snare Drum (H)	♩	♪	♩	♪	♩	♪	♩	♪
	Bass Drum	♪	♩	♪	♩	♪	♩	♪	♩
	Tempo Lamp	○		○		○		○	

■ Starting Rhythm with the Foot Switch

Although the foot switch is mainly for stopping and then restarting the rhythm, you can turn on the rhythm with either start switch, then shut it off with the foot switch before beginning to play. This way, when you are ready for the rhythm you can switch it on with your foot.

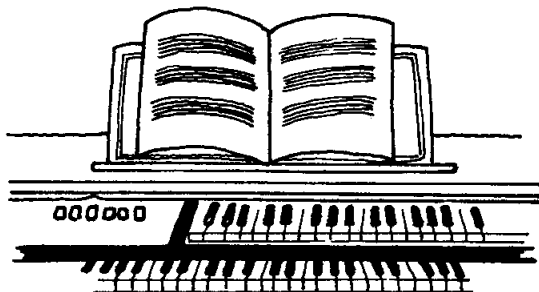

WHEN THE SAINTS GO MARCHIN' IN

Fast (tacet) start with Foot Switch traditional

Oh, when the Saints go march-in' in, Oh, when the

Saints go march-in' in, Oh Lord I

want to be in that num-ber When the

stop with Foot Switch

Saints go march-in' in. And when the in. Last

The musical score is written on a single treble clef staff in common time (C). It begins with a 'Fast (tacet)' instruction and a 'start with Foot Switch' box. The melody consists of quarter notes and half notes. Chord symbols C, G7, F, and (Fm) are placed above the staff. The lyrics are: 'Oh, when the Saints go march-in' in, Oh, when the Saints go march-in' in, Oh Lord I want to be in that num-ber When the Saints go march-in' in. And when the in. Last'. A 'stop with Foot Switch' box is placed above the staff during the final phrase. The score ends with a repeat sign and the word 'Last'.



2. Waltz

Ideal for any 3/4 selection.

Examples :

- 13 Jours en France
- I Really Don't Want to Know
- L'Eau Vive
- Moon River
- Theme from The Godfather



Rhythm	Instruments	Rhythm Pattern
WALTZ	Cymbal 1	♪ ♯ ♯ ♪ ♯ ♯
	Cymbal 2	♯ ♪ ♪ ♯ ♪ ♪
	Bass Drum	♪ ♯ ♯ ♪ ♯ ♯
	Tempo Lamp	○ ○



3. Swing

This beat is ideal for 4/4 tunes: light and bouncy melodies or slow ballads.

Mixed with the March rhythm the addition of the bass drum accent will help build dramatic feeling from the middle of the song (i.e., in refrains).

Examples :

- Satin Doll
- Petite Fleur
- Memories of You
- Twilight Time
- Michele
- Raindrops Keep Fallin' On My Head



Rhythm	Instruments	Rhythm Pattern
SWING	Cymbal 1	♪ ♯ ♪ ♯ ♪ ♯ ♪ ♯
	Cymbal 2	♯ ♪ ♯ ♪ ♯ ♪ ♯ ♪
	Snare Drum (H)	♯ ♪ ♯ ♪ ♯ ♪ ♯ ♪
	Bass Drum	♪ ♯ ♪ ♯ ♪ ♯ ♪ ♯
	Tempo Lamp	○ ○

4. Slow Rock

Best for 4/4 or 12/8 songs with triplet rhythms (i.e., rock ballads).

Mix this beat with Waltz for a fuller, rhythm.

Examples :

- La Novia
- Only You
- The House of the Rising Sun
- You Don't Have to Say You Love Me



Rhythm	Instruments	Rhythm Pattern
SLOW ROCK	Cymbal 2	
	Snare Drum (H)	
	Bass Drum	
	Drum	

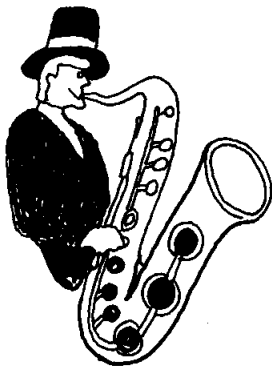

5. Jazz Rock

Suited to any 4/4 rock number.

Mixed with Swing, this beat produces an interesting Jazz Rock variation. Combined with Samba it becomes a Latin Rock. Use it together with Rhumba or Bossanova for a cha-cha mambo type rhythm.

Examples :

- Hey Jude
- Love Story

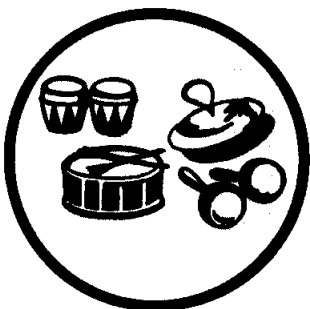

Rhythm	Instruments	Rhythm Pattern
JAZZ ROCK	Cymbal 2	
	Cymbal 1	
	Snare Drum (H)	
	Bass Drum	
	Drum	

6. Rhumba

Use this beat with any 4/4 latin selection.

The balance control is particularly important here. If it is turned completely to the right the beat is very much like a beguine. Turn all the way to the left and the bongos are accentuated for a stronger rhumba flavor. Experiment by combining this rhythm with Samba, Bossanova and Jazz Rock.

Examples :

- Tea for Two (cha cha cha)
- Cerezo Rosa
- Patricia
- Solamente Una Vez
- Begin the Beguine
- Estrellita



Rhythm	Instruments	Rhythm Pattern
RHUMBA	Cymbal 2	♪ ♪ ♪ ♪ ♪ ♪ ♪ ♪
	Cymbal 1	♪ ♪ ♪ ♪ ♪ ♪ ♪ ♪
	High Bongo	♪ ♪ ♪ ♪ ♪ ♪ ♪ ♪
	High Claves	♪ ♪ ♪ ♪ ♪ ♪ ♪ ♪
	Low Claves	♪ ♪ ♪ ♪ ♪ ♪ ♪ ♪
	Bass Drum	♪ ♪ ♪ ♪ ♪ ♪ ♪ ♪

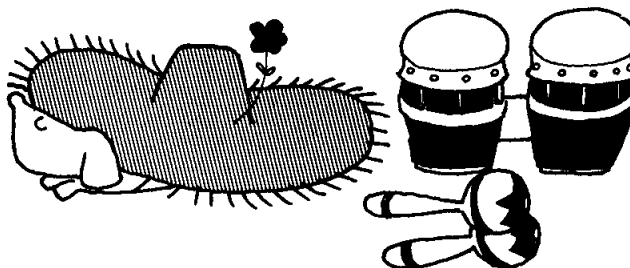

7. Bossanova

For any bossanova number in 4/4 time.

The balance control lets you adjust for a bossa-rock, or cool beat by reducing the drums.

Combines well with rock and latin rhythms, such as Samba and Jazz Rock.

Examples :

- The Girl from Ipanema
- Summer Samba
- Fly Me to the Moon
- And I Love Her
- More

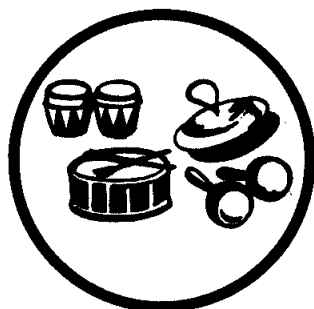

Rhythm	Instruments	Rhythm Pattern
BOSSANOVA	Cymbal 2	♪ ♪ ♪ ♪ ♪ ♪ ♪ ♪
	Cymbal 1	♪ ♪ ♪ ♪ ♪ ♪ ♪ ♪
	High Bongo	♪ ♪ ♪ ♪ ♪ ♪ ♪ ♪
	Bass Drum	♪ ♪ ♪ ♪ ♪ ♪ ♪ ♪

8. Samba

Good with 4/4 or 2/2 time latin numbers. This is the original rhythm from which the bossanova was born, so any bossanova type song can be played with a slow Samba beat for a lightly different feeling.

Examples :

- Cumana
- Brazil
- Tico Tico
- Love Me Tonight
- Girl I'm Gonna Get You

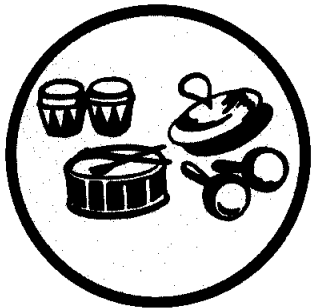

Rhythm	Instruments	Rhythm Pattern
SAMBA	Cymbal 2	♪ ♪ ♪ ♪ ♪ ♪ ♪ ♪
	Cymbal 1	♪ ♯ ♪ ♯ ♪ ♯ ♪ ♯
	High Bongo	♪ ♪ ♯ ♪ ♪ ♪ ♯ ♯
	High Claves	♪ ♯ ♯ ♪ ♪ ♯ ♯ ♪
	Low Claves	♯ ♪ ♪ ♯ ♯ ♪ ♪ ♯
	Bass Drum	♪ ♯ ♪ ♯ ♪ ♯ ♪ ♯

■ Auto Rhythm Solo

This is especially effective with a samba, but can be enjoyed as a break in any number. Make your own mixture of the first six beats on the left side for an interesting or unusual rhythm pattern. The trick here is to always use the rhythm in two-bar units.

Examples :

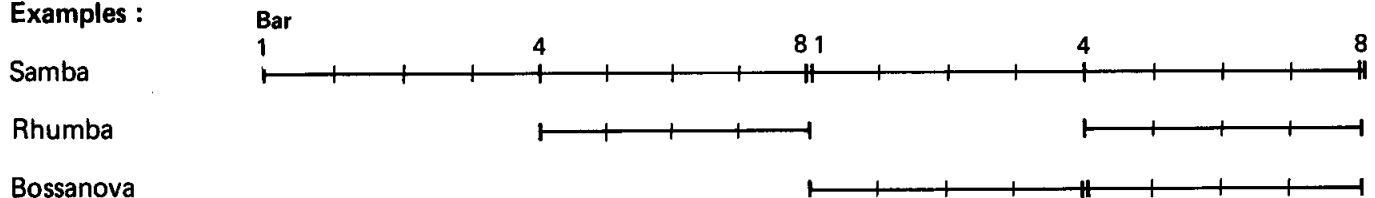

PLAYING THE YAMAHA ELECTONE

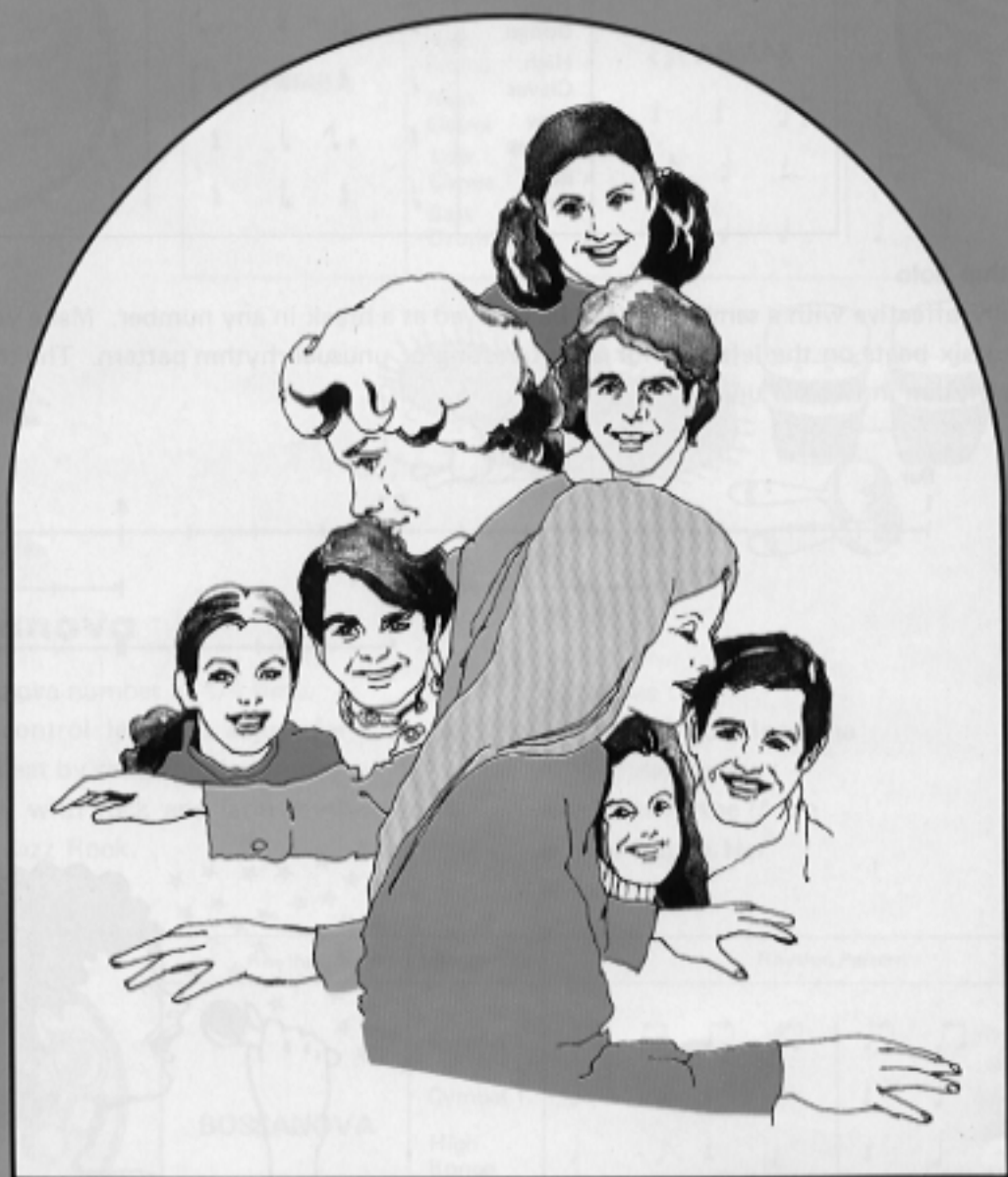

Let's Learn to Read Music

1

All music is expressed in the form of notes written on the lines and spaces of a staff. The treble clef sign shows the notes to be played by your right hand on the upper manual.

MUSICAL STAFF

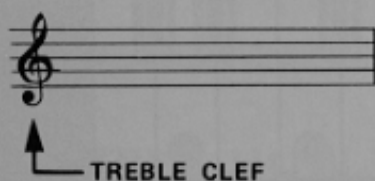

2

In your first songs, you'll be playing five melody notes: C, D, E, F, and G.

FINGER NUMBERS

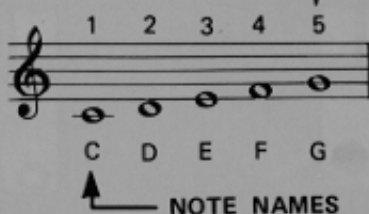

3

To help you move smoothly from note to note, right-hand finger numbers are placed above the music. This is how the fingers of your right hand are numbered.

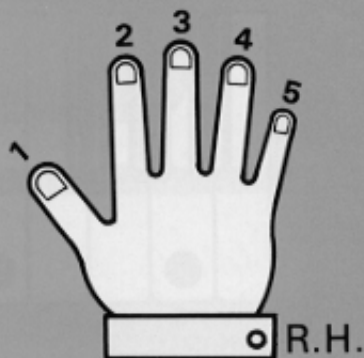

Easy Steps to Playing the Right-Hand Melody

The notes written on a musical score correspond to the keys as shown in this diagram:

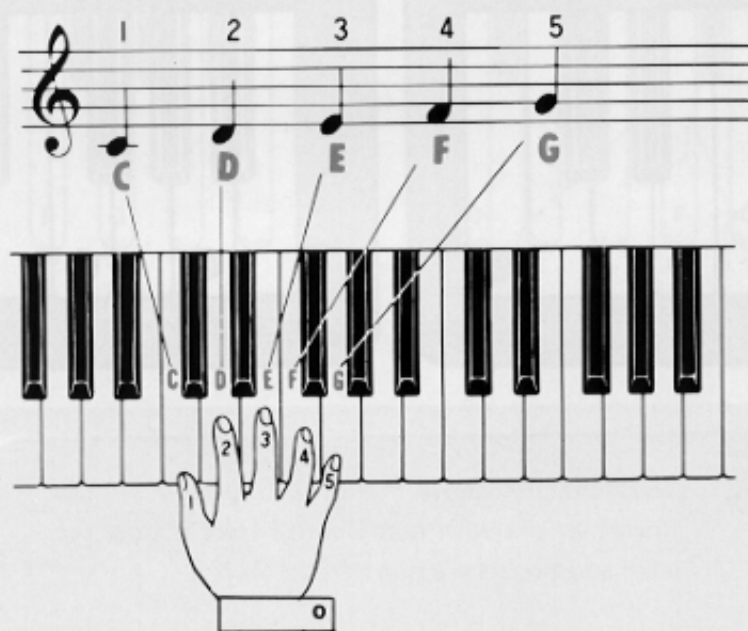

Follow the fingering above the notes.

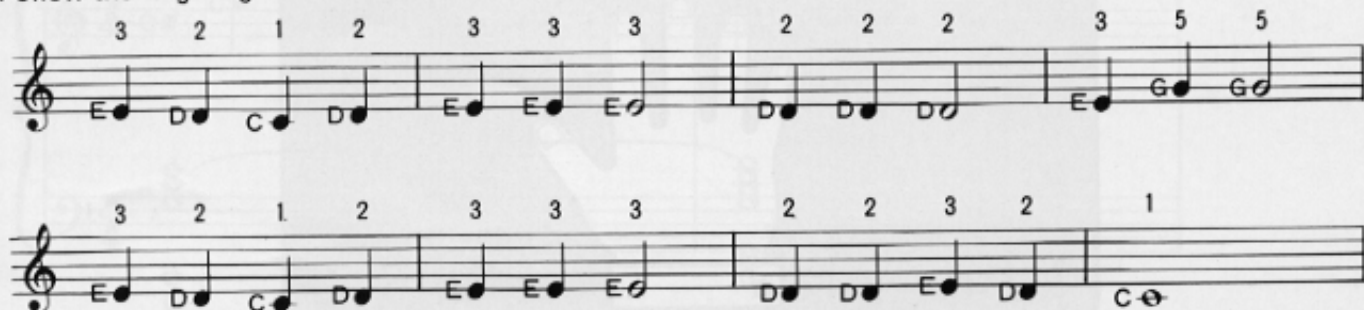

Let's Play Accompaniment

To add an interesting background to the melody, play left-hand chords on the lower manual as an accompaniment. A chord is a group of three or more notes played at the same time. The first four chords you'll learn are the C, G, F and G7 Chord.

C CHORD

FINGER NUMBERS

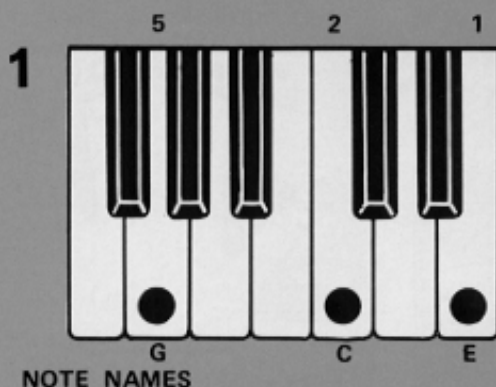

G CHORD

FINGER NUMBERS

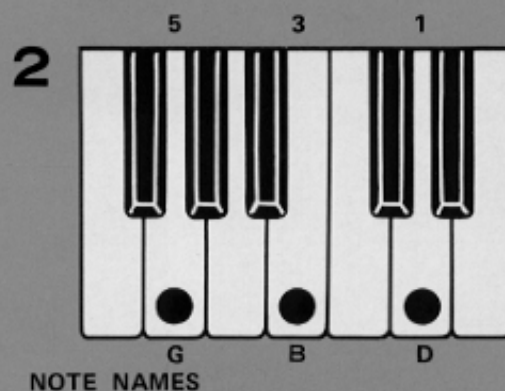

F CHORD

FINGER NUMBERS

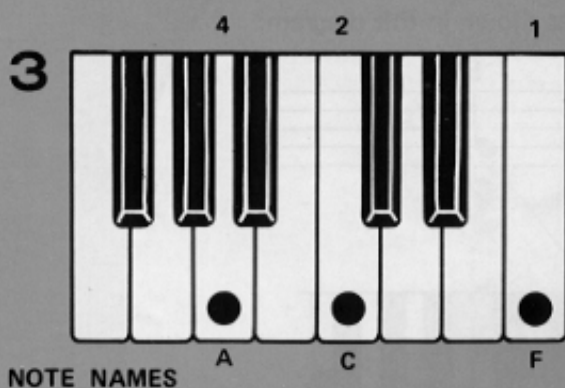

G7 CHORD

FINGER NUMBERS

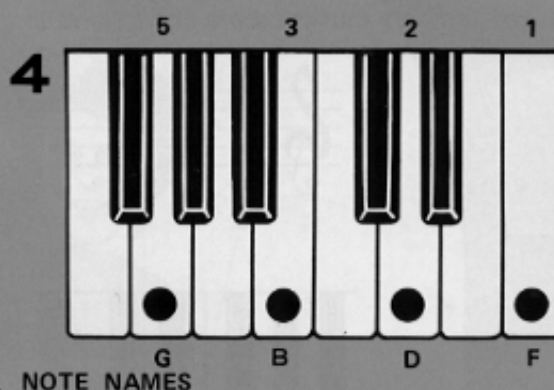

5 The numbers above these keyboards show the fingers to use with each chord. Here is how the left-hand fingers are numbered.

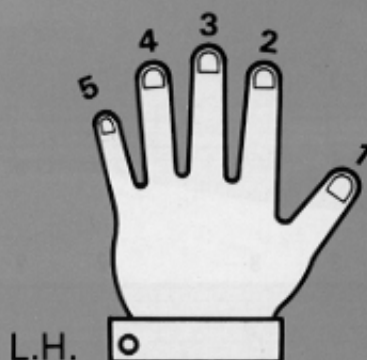

6

The pedal notes add fullness to your songs. You should accompany each chord with a matching pedal. Play the C pedal with the C chord, and the G pedal with the G chord. Play these two chords and pedals several times, and your chord changing skill will improve rapidly.

HERE'S HOW TO LOCATE THE PEDALS

To locate C pedal, swing your leg to the left past all pedals and return to the first pedal which is C.

To locate G pedal, swing your leg toward center of pedals and lightly touch the first black pedal in the group of three. Then pass in front of the black pedal to G.

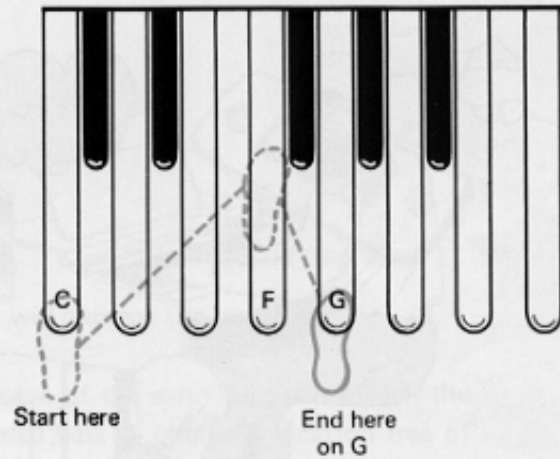
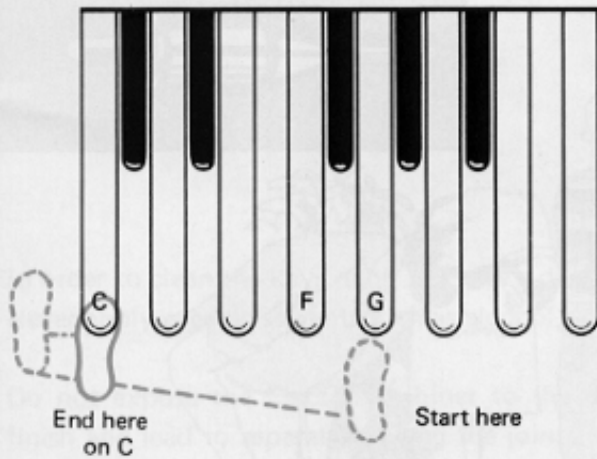

Let's Play Practice Numbers

C
F
G7
C

1 4 3 4
5 2 5
4 3 2 3
4

C
F
G
C

To Fully Enjoy Your Electone

Headphone Jack

Plug a headphone set (optional accessory) into the jack under the keyboard and you can play with the volume as high as you like without disturbing anyone, even in the middle of the night.

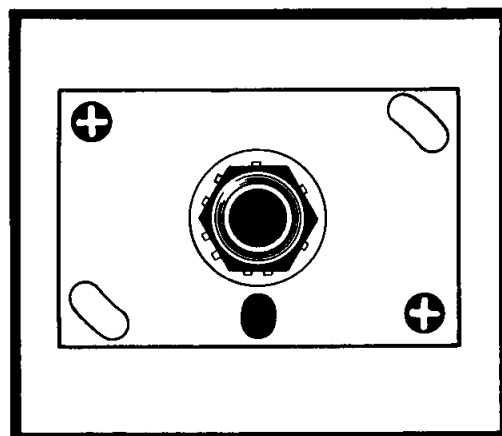

External Input Jack (EXT. IN)

Can be used to feed any sound source through the Electone speaker: radio, record player or tape recorder. Since the volume of these sound sources is not affected by the expression pedal, you can play along on the Electone with any other performance.

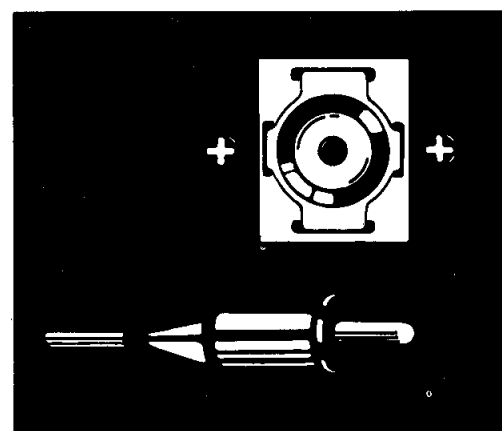

Care of Your Electone

In general you should treat your Electone with the same care you would give any fine musical instrument. However, the following points are suggested to assure optimum enjoyment.

1. Be sure to use your Electone only on the correct voltage.
If any changes are required, please consult your Yamaha Electone service agent.

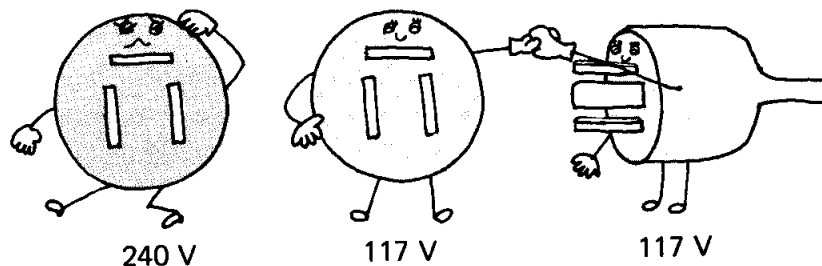

2. If any trouble develops, contact your service agent.
Never touch the circuits or the internal elements of the Electone yourself.
3. When you have finished playing, be sure to turn off the power switch.

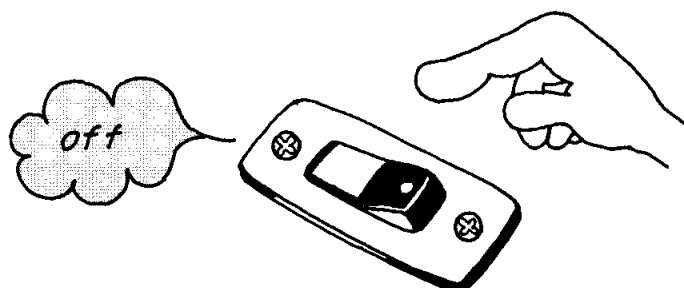

4. In order to clean the keys, tabs, etc., use a damp cloth.
Never apply organic solvents such as alcohol, for they will damage the materials.
5. Do not expose the Electone cabinet to the direct rays of the sun. This can bleach the finish and lead to separation along the joints. It is also best to choose a location free of humidity and currents of heated air.

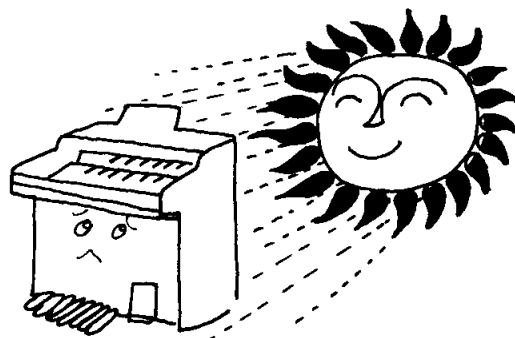

6. Be careful not to strike or scratch the cabinet with a hard object.
7. In opening and closing the fallboard, grasp the front lip with both hands and slide it gently in its groove. Never attempt to raise the fallboard directly upwards. Do not place heavy objects on it.

Do not Be Alarmed If _____

1. A note should sound the instant you turn on the switch.

This merely indicates normal operation consequent to a surge of electricity in the main amplifier.

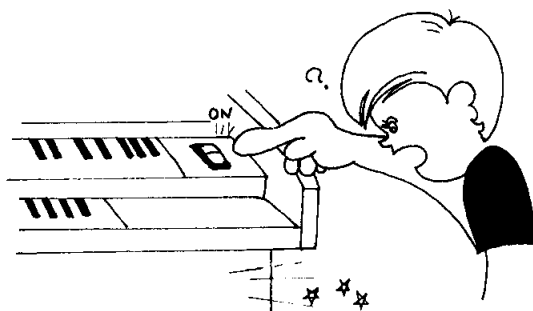

2. Only one note is produced even when two pedals are depressed simultaneously.

In order to achieve tonal clarity, the Electone is designed so that a note is electronically suppressed the instant the next note is struck. If two pedals are struck simultaneously, only the higher one sounds.

3. Occasional unpleasant static occurs.

In the majority of such cases, the cause can be traced to the turning on or off of refrigerators, washing machines, electric pumps or other household appliances. Electrical fault in a neighboring outdoor neon sign may also be to blame.

When the cause is a home appliance, connect the Electone to an outlet as far as possible away from the offending appliance. This phenomenon, although annoying, poses no danger to the Electone circuitry.

If the cause is a fault in a neon or fluorescent lighting fixture, it should be repaired. When the cause is unknown, or in case of doubt, contact your Yamaha dealer.

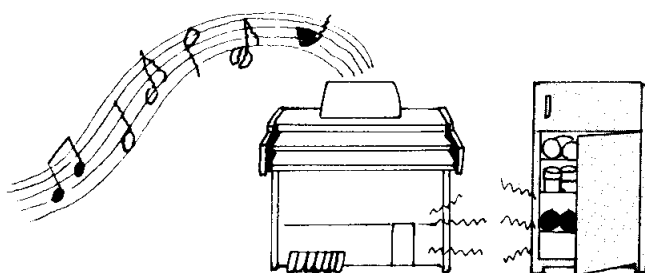

4. The Electone can at times reproduce radio or TV sound signals.

This can occur when there is a powerful radio or TV transmitter, or an amateur radio operator located in the vicinity. If the situation is distracting, contact your Yamaha dealer.

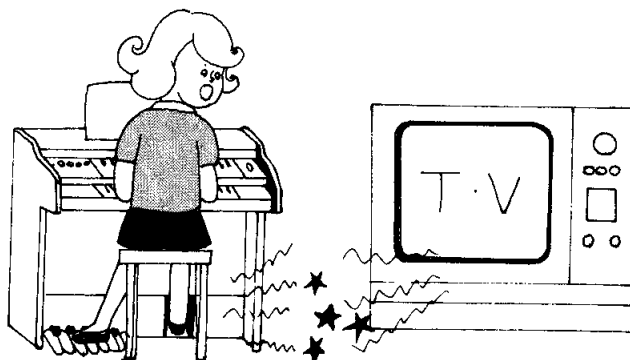

5. Sound rattling (sympathetic vibration) occurs.

All materials have critical resonance frequencies at which they vibrate. Since the Electone produces continuous tones, it is only normal that some will cause windows, shelves, etc. to rattle.

6. Pedal notes sound too high, and upper manual notes too low.

This feeling may be especially strong for players who switch from the piano, because of the difference in tonal construction. Each piano note is a combination of complicated harmonics, and can be heard only in its interaction with the surroundings. But Electone harmonics are only multiples of the integral (base) tone, and so the instrument cannot be tuned in the same way as a piano.

7. There is a bit of noise when the rotary speaker is switched on.

This too is a mechanical noise stemming from the spinning speaker. Special mountings help keep this sound at an absolute minimum.

Specifications

■ KEYBOARDS

Upper Manual	44 keys	f ~ c4
	(3 $\frac{2}{3}$ octaves)	
Lower Manual	44 keys	F ~ c3
	(3 $\frac{2}{3}$ octaves)	
Pedals	13 keys	C1 ~ C
	(1 octave)	

■ TONE LEVERS

Upper Manual	Flute	16'
	Trombone	16'
	Flute	8'
	Oboe	8'
	String	8'
Lower Manual	Flute	4'
	Wood	8'
	Horn	8'
Pedals	Cello	8'
	Bass	16'
	Bass	8'

■ EFFECT LEVERS

Vibrato
Percussive 4' (Upper)
Percussive Length (Upper)
Pedal Sustain

■ EFFECT CONTROLS

Reverb
Reverb Balance (Upper/Lower)

■ TREMOLO SELECTORS

Voice (Main/Tremolo)
Tremolo
Chorus

■ AUTO RHYTHM SECTION

Rhythm Selectors	
March	Jazz Rock
Waltz	Rhumba
Swing	Bossanova
Slow Rock	Samba
Rhythm Controls	
Rhythm Start	
Synchro-Start	
Rhythm Stop (Foot control)	
Tempo	
Volume	
Tone Balance	
Tempo Indicator Lamp	

■ OTHER CONTROLS

Expression Pedal
Rhythm Foot Switch
Power Switch
Pilot Lamp
Tremolo Speed Control

■ OTHER FITTINGS

Headphone Jack
External Input Jack
Roll-top Fallboard
Music Rest
Matching Bench

■ NATURAL SOUND SPEAKERS

Main:	Yamaha JA-3055	30cm (12")
Tremolo:	JA-1701A	16 x 23cm (6½ x 9")
Electro-control 2-speed		

■ CIRCUITRY

Solid State (Incl. ICs and FETs)	
Output Power:	15 Watts (RMS)
Power Consumption:	60 Watts
Power Source:	100/110/117/125/ 220/240V AC 50/60Hz

■ DIMENSIONS

Width:	111cm (43¾")
Depth:	56cm (22")
Height:	90cm (35¼")

WEIGHT

58 kg (128 lbs.)

■ FINISH

American Walnut Grain

Specifications subject to change without notice.

SINCE 1887



YAMAHA

NIPPON GAKKI CO., LTD. HAMAMATSU, JAPAN