

YAMAHA

FRONT

DSP-A990

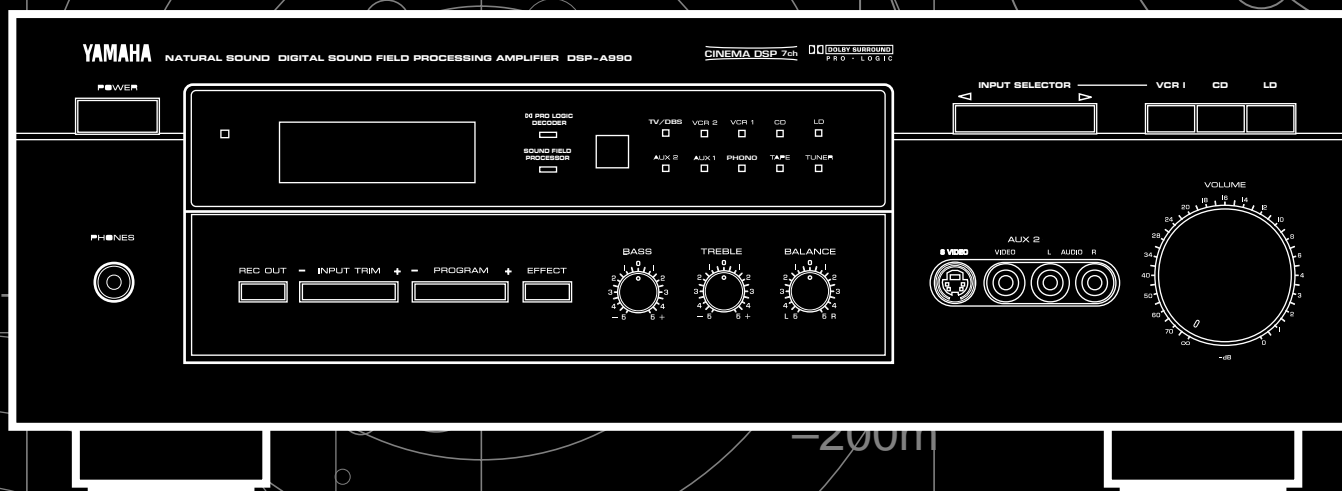

DIGITAL SOUND FIELD PROCESSING AMPLIFIER / OPERATION MANUAL

AMPLIFICATEUR DE TRAITEMENT DE CHAMP SONORE NUMERIQUE / MODE D'EMPLOI

DIGITAL-KLANGFELDVERSTÄRKER / BEDIENUNGSANLEITUNG

DIGITAL LJUDFÄLTSFÖRSTÄRKARE / BRUKSANVISNING

AMPLIFICATORE DIGITALE DI PROCESSAMENTO DEL CAMPO SONORO / LIBRETTO D'ISTRUZIONI

AMPLIFICADOR DE PROCESAMIENTO DE CAMPO DE SONIDO DIGITAL / MANUAL DE INSTRUCCIONES

BEDIENINGSHANDLEIDING VOOR DIGITALE GELUIDSVELDPROCESSING-VERSTERKER

Congratulations!

You are the proud owner of a Yamaha Digital Sound Field Processing (DSP) System—an extremely sophisticated audio component. The DSP system takes full advantage of Yamaha's undisputed leadership in the field of digital audio processing to bring you a whole new world of listening experiences. Follow the instructions in this manual carefully when setting up your system, and the DSP system will sonically transform your room into a wide range of listening environments—anything from a famous concert hall to a cozy jazz club. In addition, you get incredible realism from Dolby-Surround encoded video sources using the built-in Dolby Pro Logic Surround Decoder.

Seven built-in channels of amplification on the DSP-A990 mean that no additional amplifiers are required to enjoy advanced digital sound field processing.

Rather than tell you about the wonders of digital sound field processing, however, let's get right down to the business of setting up the system and trying out its many capabilities. Please read this operation manual carefully and store it in a safe place for later reference.

PRECAUTIONS & SAFETY INSTRUCTIONS

SAFETY INSTRUCTIONS

1. AVOID EXCESSIVE HEAT, HUMIDITY, DUST AND VIBRATION

Keep the unit away from locations where it is likely to be exposed to high temperatures or humidity—such as near radiators, stoves, etc. Also avoid locations which are subject to excessive dust accumulation or vibration which could cause mechanical damage.

2. INSTALL THE UNIT IN WELL-VENTILATED CONDITION

The openings on the cabinet assure proper ventilation of the unit. If these openings are obstructed, the temperature inside the cabinet will rise rapidly. Therefore, avoid placing objects against these openings, and install the unit in well-ventilated condition. Make sure to allow a space of at least 10 cm behind and on the both sides and at least 20 cm above the top panel of the unit. Otherwise it may not only damage the unit, but also cause fire.

3. KEEP THE AC POWER PLUG DISCONNECTED DURING VACATION ETC.

When not planning to use this unit for long periods of time (ie., vacation, etc.), disconnect the AC power plug from the wall outlet.

4. AVOID PHYSICAL SHOCKS

Strong physical shocks to the unit can cause damage. Handle it with care.

5. DO NOT OPEN THE UNIT OR ATTEMPT REPAIRS OR MODIFICATIONS YOURSELF

This product contains no user-serviceable parts. Refer all maintenance to qualified Yamaha service personnel. Opening the unit and/or tampering with the internal circuitry will make servicing difficult and will endanger you and your unit.

6. MAKE SURE POWER IS OFF BEFORE MAKING OR REMOVING CONNECTIONS

Always turn power OFF prior to connecting or disconnecting cables. This is important to prevent damage to the unit itself as well as other connected equipment.

7. HANDLE CABLES CAREFULLY

Always plug and unplug cables—including the AC cord—by gripping the connector, not the cord.

8. CLEAN WITH A SOFT DRY CLOTH

Never use solvents such as benzine or thinner to clean the unit. Wipe clean with a soft, dry cloth.

9. ALWAYS USE THE CORRECT POWER SOURCE

Make sure that the power source voltage specified on the rear panel matches your local AC mains supply.

10. KEEP AWAY FROM TUNERS

Digital signals generated by the unit may interfere with other equipment such as tuners, receivers or TVs. Move the system farther away from such equipment if interference is observed.

IMPORTANT!

Please record the model and serial number of your unit in the space below.

Model:

Serial No.:

The serial number is located on the rear of the unit. Retain this Owner's Manual in a safe place for future reference.

Voltage Selector (General Model only)
The voltage selector on the rear panel of this unit must be set for your local mains voltage BEFORE plugging into the AC mains supply.
Voltages are 110/120/220/240 AC, 50/60 Hz.

WARNING

To reduce the risk of fire or electric shock, do not expose this unit to rain or moisture.

For U.K. customers

If the socket outlets in the home are not suitable for the plug supplied with this appliance, it should be cut off and an appropriate 3 pin plug fitted. For details, refer to the instructions described below.

Note: The plug severed from the mains lead must be destroyed, as a plug with bared flexible cord is hazardous if engaged in a live socket outlet.

SPECIAL INSTRUCTIONS FOR U.K. MODEL

IMPORTANT

The wires in the mains lead are coloured in accordance with the following code.

Blue: NEUTRAL

Brown: LIVE

As the colours of the wires in the mains lead of this apparatus may not correspond with the coloured markings identifying the terminals in your plug, proceed as follows. The wire which is coloured BLUE must be connected to the terminal which is marked with the letter N or coloured BLACK. The wire which is coloured BROWN must be connected to the terminal which is marked with the letter L or coloured RED. Making sure that neither core is connected to the earth terminal of the three pin plug.

This product complies with the radio frequency interference requirements of the Council Directive 82/499/EEC and/or 87/308/EEC.

The apparatus is not disconnected from the AC power source as long as it is connected to the wall outlet, even if the apparatus itself is turned off.

CONTENTS

PRECAUTIONS & SAFETY INSTRUCTIONS	1	CREATING YOUR OWN SOUND FIELDS	40
SETUP & ADJUSTMENT	3	3-1. SELECTING AND EDITING PROGRAM PARAMETERS	40
1-1. GETTING STARTED.....	3	3-2. DESCRIPTIONS OF THE DIGITAL SOUND FIELD	
1-2. SETUP.....	10	PARAMETERS.....	42
1-3. CONTROLS & ADJUSTMENTS	20	TROUBLESHOOTING	45
1-4. ADJUSTMENT	24	SPECIFICATIONS	46
GENERAL OPERATION	28		
2-1. PLAYING A SOURCE	28		
2-2. RECORDING A SOURCE TO AUDIO/VIDEO TAPE			
(OR DUBBING FROM A TAPE TO ANOTHER).....	29		
2-3. DIGITAL SOUND FIELD PROGRAMS	31		
2-4. SELECTING SOUND FIELD PROGRAMS	31		
2-5. MUTING THE EFFECT SOUND	32		
2-6. SUPERIMPOSED VIDEO PROGRAM/PARAMETER			
DISPLAY	32		
2-7. DESCRIPTIONS OF THE SOUND FIELD PROGRAMS	33		
2-8. REMOTE CONTROL “LEARNING” FUNCTION.....	38		

SETUP & ADJUSTMENT

1-1. GETTING STARTED

Unpacking

If you haven't already done so, carefully remove this unit and its accessories from the box and wrapping material. You should find the unit itself and the following accessories.

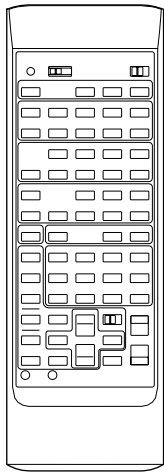

Remote control

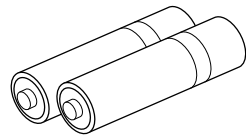

Batteries

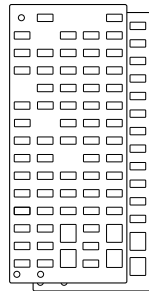

User program sheets

Installing the Remote Control Unit Batteries

Since the remote control unit will be used for many of this unit's control operations, you should begin by installing the supplied batteries.

1. Turn the remote control unit over and slide the battery compartment cover downward in the direction of the arrow.

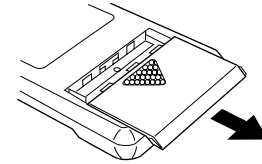

2. Insert the batteries (R6, AA, UM-3 type), being careful to align them with the polarity markings on the inside of the battery compartment.

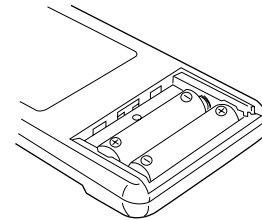

3. Close the battery compartment cover.

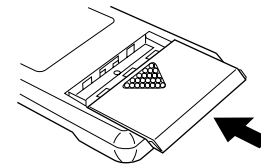

- When you notice that remote control operation has become erratic, or the distance from which the remote control will function has decreased, it's time to replace the batteries. Always replace all batteries at the same time.
- Make sure that the YPC/USER/LEARN switch on the remote control unit is set to the YPC or USER position for normal operation.
- This remote control uses an advanced, highly directional infrared beam. Be sure to aim the remote control directly at the remote control sensor on the main unit when operating.

Remote control transmitter operation range

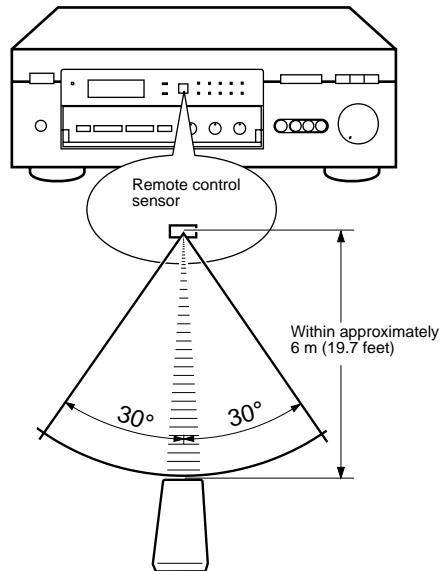

Notes

- There should be no large obstacles between the remote control transmitter and the main unit.
- If the remote control sensor is directly illuminated by strong lighting (especially an inverter type of fluorescent lamp etc.), it might cause the remote control transmitter to work incorrectly. In this case, reposition the main unit to avoid direct lighting.

Digital Sound Field Processing

What is it that makes live music so good? Today's advanced sound reproduction technology lets you get extremely close to the sound of a live performance, but chances are you'll still notice something missing, the acoustic environment of the live concert hall. Extensive research into the exact nature of the sonic reflections that create the ambience of a large hall has made it possible for Yamaha engineers to bring you this same sound in your own listening room, so you'll feel all the sound of a live concert. What's more, our technicians, armed with sophisticated measuring equipment, have even made it possible to capture the acoustics of a variety of actual concert halls, jazz clubs, theaters, etc. from around the world, to allow you to accurately recreate any one of these live performance environments, all in your own home.

Dolby Pro Logic Surround

The Dolby Pro Logic Surround Decoder program lets you experience the dramatic realism and impact of Dolby Surround movie theater sound in your own home. Dolby Pro Logic gets its name from its professional-grade steering logic circuitry, which provides greater effective channel separation for a much higher degree of realism than the “passive” Dolby Surround circuits found in today’s typical home audio/video equipment. Dolby Pro Logic Surround provides a true center channel, so that there are four independent channels, unlike passive Dolby Surround, which has in effect only three channels: left, right, and rear. This center channel allows listeners seated in even less-than-ideal positions to hear the dialog originating from the action on the screen while experiencing good stereo imaging.

This Dolby Pro Logic Surround Decoder employs a digital signal processing system. This system improves the stability of sound at each channel and crosstalk between channels, so that positioning of sounds around the room is more accurate compared with conventional analog signal processing systems.

In addition, this unit features a built-in automatic input balance control. This always assures you the best performance without manual adjustment.

Manufactured under license from Dolby Laboratories Licensing Corporation. Additionally licensed under Canadian patent number 1,037,877. “Dolby”, “Pro Logic”, and the double-D symbol are trademarks of Dolby Laboratories Licensing Corporation.

Dolby Pro Logic Surround + DSP

Additionally you can enjoy sound environment created by the combination of Dolby Pro Logic and YAMAHA DSP. Precise sound movement and orientation by the Dolby Pro Logic technology is added to sound fields which are precisely recreated on the basis of actual acoustic environments by the DSP technology, so it is suitable for any Audio/Video source with video image. This combination is used on sound field programs No. 8 through No. 11, and “Enhanced DOLBY PRO LOGIC” of No. 12.

CINEMA DSP 7ch

The YAMAHA “CINEMA DSP” logo indicates these programs are created by the combination of Dolby Pro Logic and YAMAHA DSP technology.

Video superimpose

If you connect your video cassette recorder, video disc player, video monitor, etc. to this unit, you can take advantage of this unit's capability to display program titles, parameter data and information about other various settings and adjustments on your video monitor's screen. This information will be superimposed over the video image.

If there is no video source connected or it is turned off, the information will be displayed over a blue colored background.

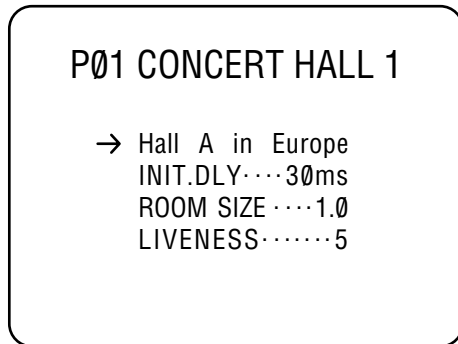

NOTE: The program titles, parameter data and other information are also displayed on the display panel of this unit.



Open/close the control door

When it is not necessary to operate controls inside the control door, close the door.

To open the door

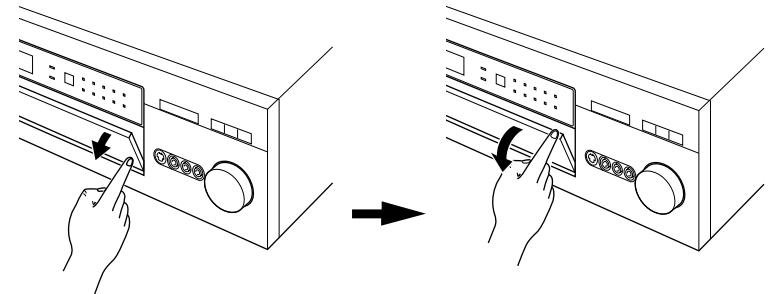

To close the door

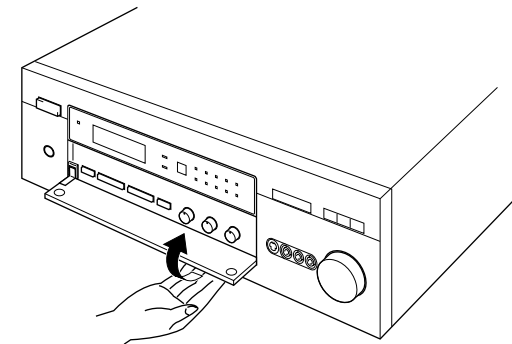

Setting Up Your Speaker System

This unit has been designed to provide the best sound field quality with a full seven-speaker system setup, using two extra pairs of effect speakers to generate the sound field plus one center speaker for dialog, when using Dolby Pro Logic Surround decoding. We therefore recommend that you use a seven-speaker setup. A four-speaker system using only one pair of effect speakers for the sound field will still provide impressive ambience and effects, however, and may be a good way to begin with this unit. You can always upgrade to the full seven speaker system later. In the 4 or 5 speaker system, the Digital Sound Field Processing is still performed, but the main speakers are used for both the main channels and the front effect channels.

Use of the Center Dialog Speaker Is Recommended

With digital sound field programs No. 8 through No. 12, by using either the Directional Enhancement circuit or the Dolby Pro Logic decoder, decoded signals will be output from the center channel. Therefore, if you want to maximize the performance of your Audio/Video home theater system, it is recommended that you use a center channel speaker.

If for some reason it is not practical to use a center speaker, it is possible to enjoy movie viewing without it. Best results, however, are obtained with the full system.

It is also possible to further expand your system with the addition of a subwoofer and amplifier. You may wish to choose the convenience of a Yamaha Active Servo Processing Subwoofer System, which has its own built-in power amp.

Four Possible Types of Speaker System Configurations Recommended

4 Speaker System

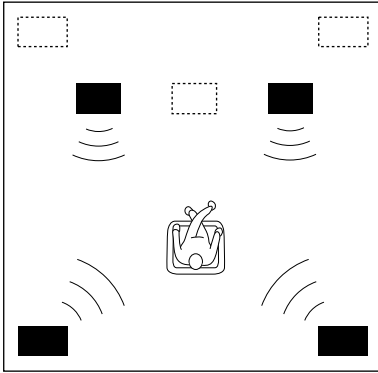

Simplest system.

You can enjoy widely diffused sound by only adding two additional speaker units at the rear.

FRONT MIX switch—Set to ON.
(See page 13.)
Center Mode—Set to PHNTM.
(See page 26.)

5 Speaker System

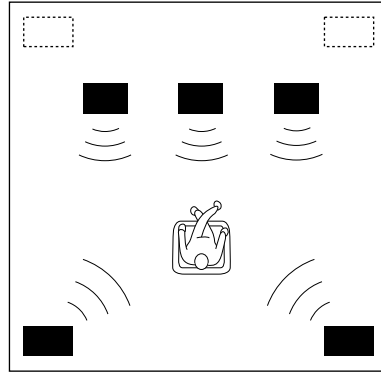

Good for Audio/Video sources and Dolby Pro Logic Surround.

With sound field programs No. 8 through No. 12, which utilize the center speaker effect, more precise center localization can be obtained.

FRONT MIX switch—Set to ON.
(See page 13.)
Center Mode—Set to NRML or WD.
(See page 26.)

6 Speaker System

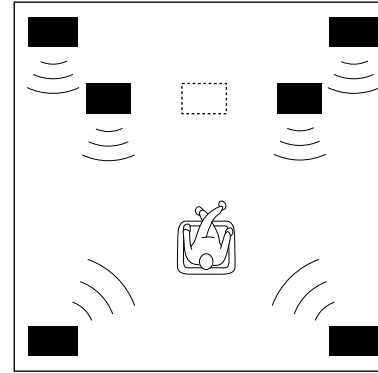

Good for sound fields from 2-channel stereo sources.

With sound field programs No. 1 through No. 7, a sound effect matching that of a 7-speaker system can be obtained. The addition of front left and right effect speakers produces a more effective sound field.

FRONT MIX switch—Set to OFF.
(See page 13.)
Center Mode—Set to PHNTM.
(See page 26.)

7 Speaker System

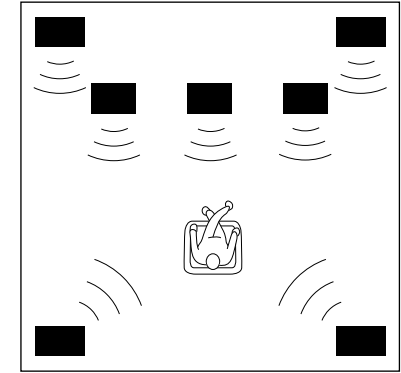

This is the recommended speaker system, providing the best sound effects.

With sound field programs No. 1 through No. 7, using both sets of effect speakers (front and rear), reproduces the most effective sound field. With the sound field programs No. 8 through No. 12, the center speaker provides precise center localization.

FRONT MIX switch—Set to OFF.
(See page 13.)
Center Mode—Set to NRML or WD.
(See page 26.)

Speakers and Speaker Placement

Your full seven-speaker system will require three speaker pairs: the MAIN SPEAKERS (your normal stereo speakers), the FRONT EFFECT SPEAKERS and the REAR EFFECT SPEAKERS, plus the CENTER SPEAKER. You may also be using a subwoofer.

You will probably use your present stereo speakers as the MAIN SPEAKER pair. The front effect and rear effect do not need to be equal with the MAIN SPEAKERS, although the center speaker should be as close as possible. They should have enough power handling capacity to accept the maximum output of the DSP system or the external amps that will drive them.

Place the MAIN SPEAKERS in the normal position.

Place the FRONT EFFECT SPEAKERS further apart than the MAIN SPEAKERS, on either side of and a few feet behind and above the MAIN SPEAKER pair.

Place the REAR EFFECT SPEAKERS behind your listening position. They should be nearly six feet up from the floor.

Place the CENTER SPEAKER precisely between the two MAIN SPEAKERS. (To avoid interference, keep the speaker above or below the television monitor, or use a magnetically shielded speaker.)

If using a SUBWOOFER, such as a Yamaha Active Servo Subwoofer System, the position of the speaker is not so critical because low bass tones are not highly directional.

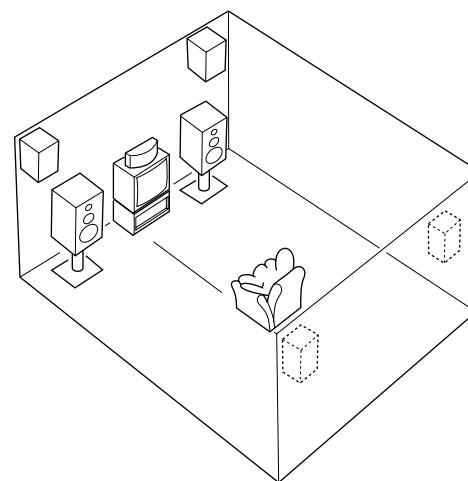

Main speaker



Effect speaker



Center speaker

1-2. SETUP

Before you start making connections make sure all related electronic components are turned OFF.

REAR PANEL

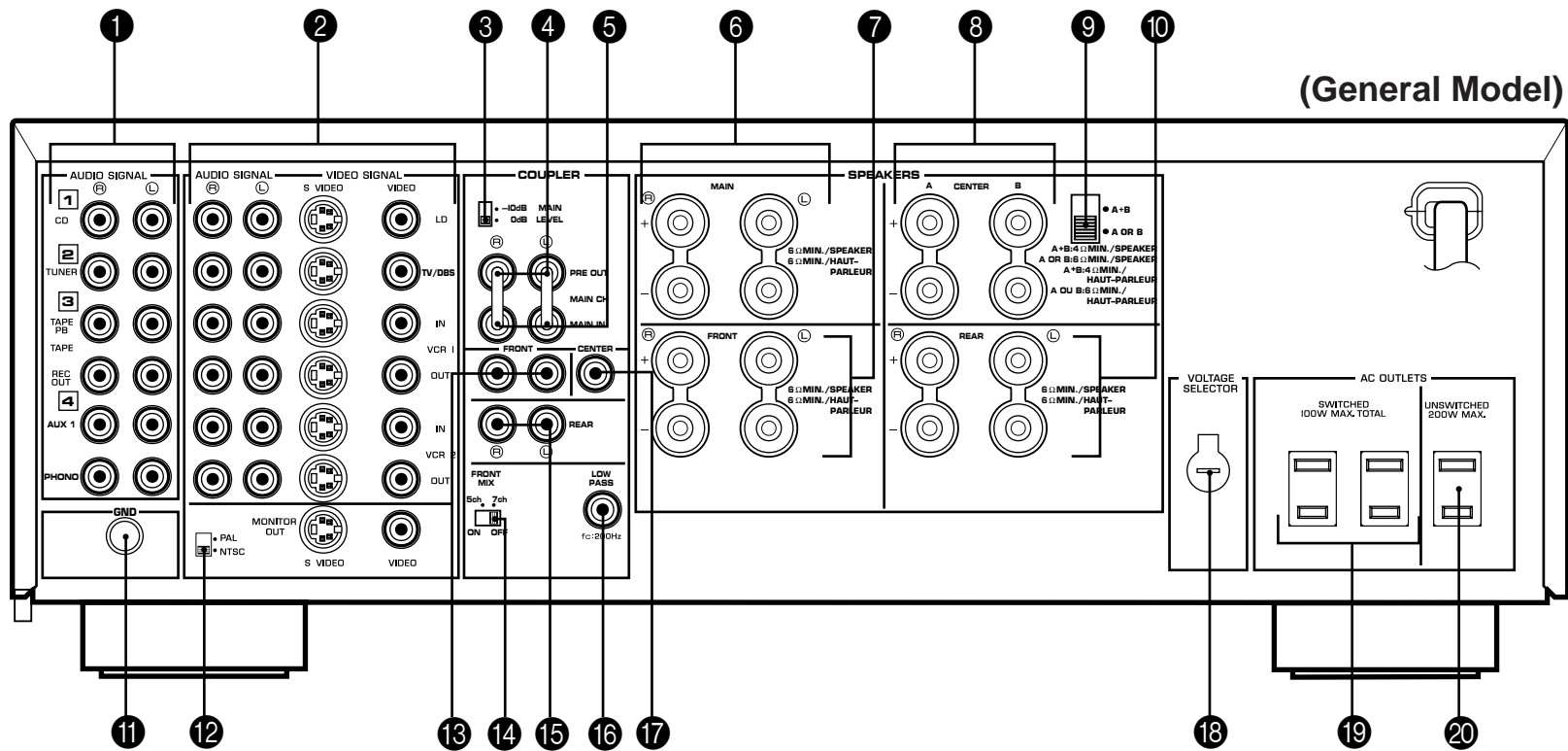

- ① **Audio Signal Connection Jacks (for Audio Source Equipment)**
Connect the inputs and/or outputs of your audio equipment.
- ② **Audio/Video Signal Connection Jacks (for Video Source Equipment)**
Connect the audio and video inputs and/or outputs of your video equipment. In place of the VIDEO jacks, the S VIDEO jacks can be used for higher resolution and improved picture quality if your VCR, monitor, etc. are equipped with S-VIDEO connectors.
- ③ **Main Level Switch**
Normally set to “0 dB”. If desired, you can decrease the main-channel output level at the MAIN speaker terminals by 10 dB by setting this switch to “-10 dB”.
- ④ **Pre Out Jacks**
Main-channel line output. Connected with jumper bars to MAIN IN jacks when the built-in amplifier is used. Connected to input jacks of external stereo power amplifier (MAIN IN or TAPE PLAY jacks of integrated amplifier or receiver) when using external amplification.
- ⑤ **Main In Jacks**
Line input to built-in main-channel amplifier. Connected with jumper bars to PRE OUT jacks when the built-in amplifier is used. Not connected when using an external power amplifier.
- ⑥ **Main Speaker Terminals**
When using this unit’s built-in main-channel amplifier, connect the main speakers here. The jumper bars must be plugged in to connect the MAIN IN jacks to the PRE OUT jacks.
- ⑦ **Front Effect Speaker Terminals**
When using the built-in front-channel amplifier, connect the front effect speakers here.
- ⑧ **Center Speaker Terminals**
When using the built-in center-channel amplifier, connect one or two center speakers here.
- ⑨ **Center Speaker Impedance Switch**
Set to “A + B” when using two center speakers, or to “A OR B” when using only one center speaker.
- ⑩ **Rear Effect Speaker Terminals**
When using the built-in rear-channel amplifier, connect the rear effect speakers here.
- ⑪ **GND Terminal**
Connects the ground wire of the turntable to produce minimum hum. In some cases, however, better results may be obtained with the ground wire disconnected.
- ⑫ **Video NTSC/PAL Switch (General Model only)**
Set this switch to the position corresponding to the standard that your video equipment employs.
- ⑬ **Front Effect Out Jacks**
Front-channel line output. Not connected when the built-in amplifier is used. Can be connected to input jacks of an external stereo power amplifier driving the front effect speakers.
- ⑭ **Front Mix Switch**
Set to “OFF (7ch)” when setting up a full 7 or 6 speaker system, or to “ON (5ch)” when setting up a 5 or 4 speaker system.
- ⑮ **Rear Effect Out Jacks**
Rear-channel line output. Not connected when the built-in amplifier is used. Can be connected to input jacks of an external stereo power amplifier driving the rear effect speakers.

16 Low Pass Jack

When using a subwoofer, connect its amplifier input to this jack. Frequencies below 200 Hz from the left main, right main and center channels are output to this jack.

17 Center Out Jack

Center-channel line output. Not connected when the built-in amplifier is used. Can be connected to input jack of an external power amplifier to drive the center speaker.

18 Voltage Selector (General Model only)

Be sure to set to the line voltage in your area before applying power. Consult your dealer if unsure of the correct setting.

19 Switched AC Outlets

You may plug other audio components into these sockets as long as their combined power consumption does not exceed the specified value shown. "Switched" means that these components are turned on and off by this unit's power switch.

20 Unswitched AC Outlet (General Model only)

The total power consumption of audio components plugged into this socket should not exceed the specified value shown. "Unswitched" means that power is available even when this unit is off.

NOTE: If an external power amplifier is connected to the front effect or rear effect output jacks, the corresponding internal amplifier will be turned off and no output will be available at the speaker terminals.

REAR PANEL SWITCH AND CONTROL SETTINGS

There are several switches and controls on the rear panel that you'll have to check before operating your system, and it's a good idea to do it before you connect cables. Locate the MAIN LEVEL slide switch (③) and FRONT MIX slide switch (⑭). Make sure the MAIN LEVEL switch is set to "0 dB" and the FRONT MIX switch is set to "OFF" for 7 or 6 speaker driving.

In a 5 or 4 speaker system, set the FRONT MIX switch to "ON".

Next, set the NTSC/PAL switch (⑫) to the position corresponding to the standard which your video equipment employs. (General Model only)

GENERAL INSTRUCTIONS FOR CONNECTIONS

Make sure that you have the left (L) and right (R) channels correctly connected. That means that jacks marked "L" on this unit must be connected to jacks marked "L" on other units. Likewise with the "R" jacks. This is easy if you remember to always use the red plug for the "R" jacks and the white plug for the "L" jacks.

With speaker connections you must also be sure that the polarity is correct. For each amplifier and each channel, connect the plus (+) terminal of the amplifier to the plus terminal of the speaker, and connect the minus (-) terminal of the amplifier to the minus terminal of the speaker. To keep track of polarity, use a speaker cable that has one of the two wires marked by a stripe or a different color.

CONNECTING AUDIO/VIDEO SOURCE EQUIPMENT TO THIS UNIT

- * If you have YAMAHA components numbered as 1, 2, 3, etc. on the rear panel, connections can be made easily by making sure to connect the output (or input) terminals of each component to the same-numbered terminals of this unit.

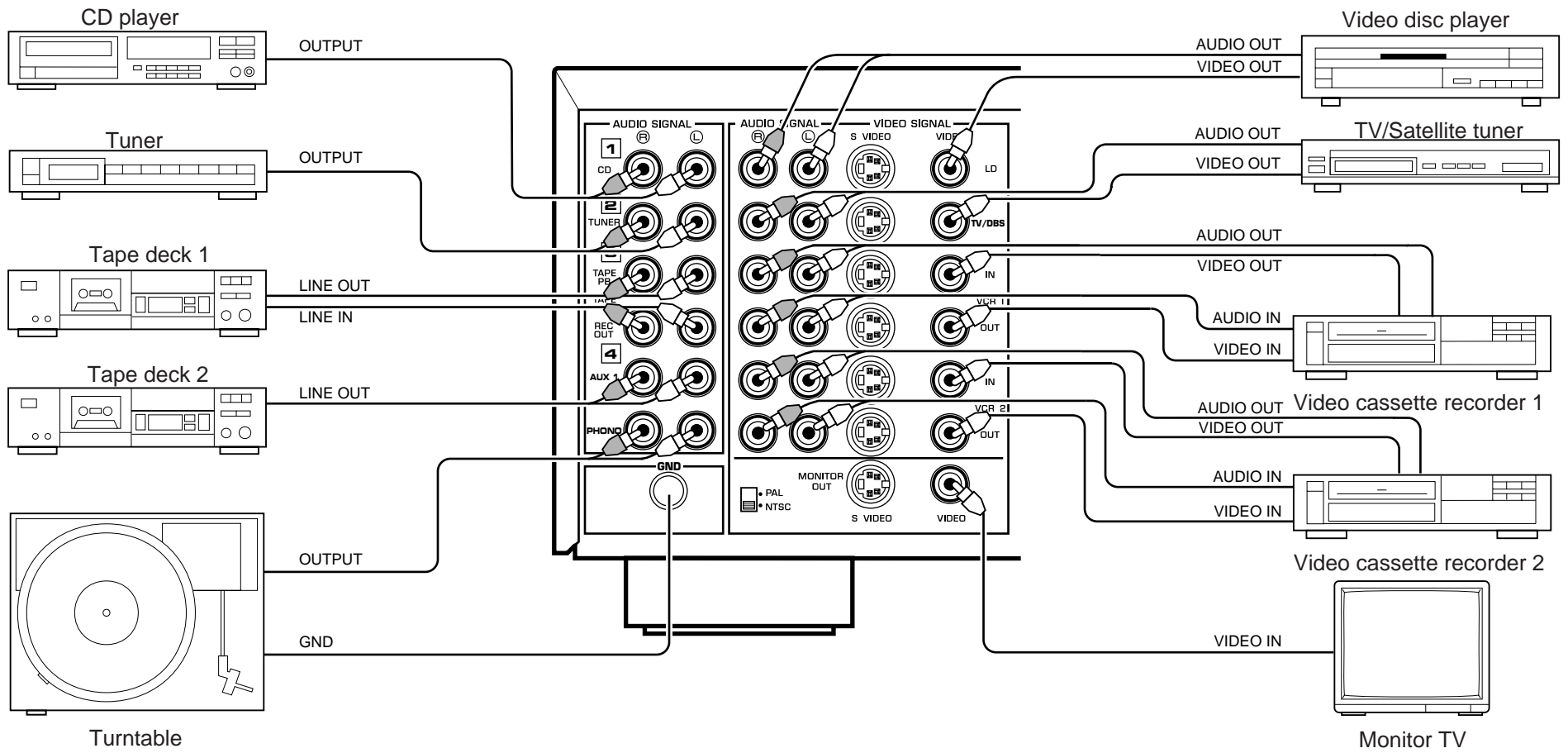

CONNECTING TO S VIDEO JACKS

If your video cassette recorder, video disc player, etc. and your monitor are equipped with “S” (high-resolution) video terminals, connect them to this unit’s S VIDEO jacks, and connect this unit’s S VIDEO MONITOR OUT jack to the “S” video input of your monitor. Otherwise, connect the composite video jacks from your video cassette recorder, video disc player, etc. to the VIDEO jacks of this unit, and connect this unit’s VIDEO MONITOR OUT jack to the composite video input of your monitor.

NOTE: If video signals are sent to both S VIDEO input and VIDEO input jacks, the signals will be sent to their respective output jacks independently.

NOTE: If your unit is the General Model, be sure the NTSC/PAL switch has been correctly set to the standard that your video equipment employs. Singapore model has no switch and uses the NTSC standard, while other models without a switch use the PAL standard.

Notes about the Video superimpose

- If you watch a video source that is connected to both S VIDEO and VIDEO input jacks of this unit, signals of screen display information are output from only the S VIDEO MONITOR OUT jack.
- When no video signal is input to either S VIDEO or VIDEO input jacks of this unit, signals of screen display information are output from both S VIDEO MONITOR OUT and VIDEO MONITOR OUT jacks with a color background.

* For the General Model, if the NTSC/PAL switch on the rear panel is set to “PAL”, nothing will be output from either S VIDEO MONITOR OUT or VIDEO MONITOR OUT jack in this case.

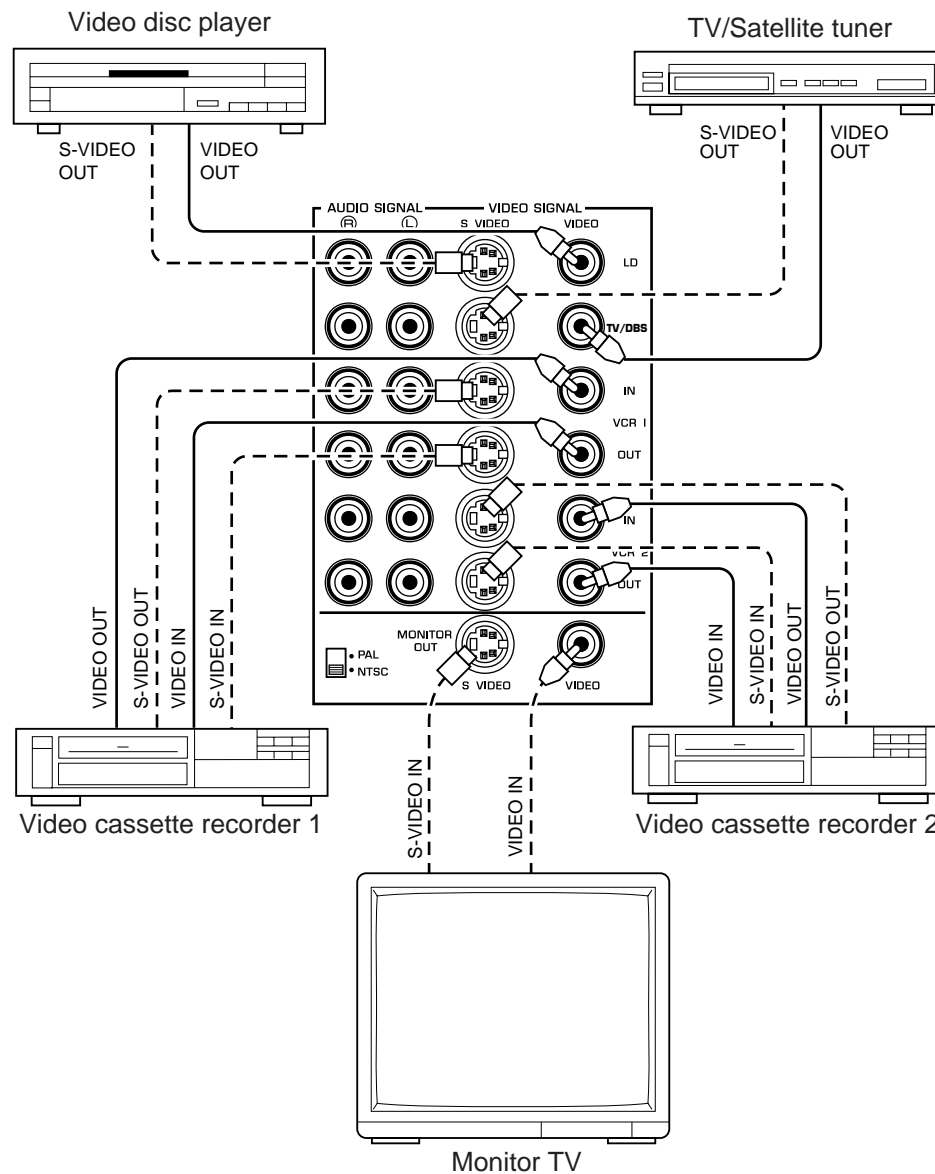

For connecting with a monitor TV that uses a 21 pin connector for input (for Europe and U.K. models)

Make a connection as figured below with a commercially available scart-plug connector cable.

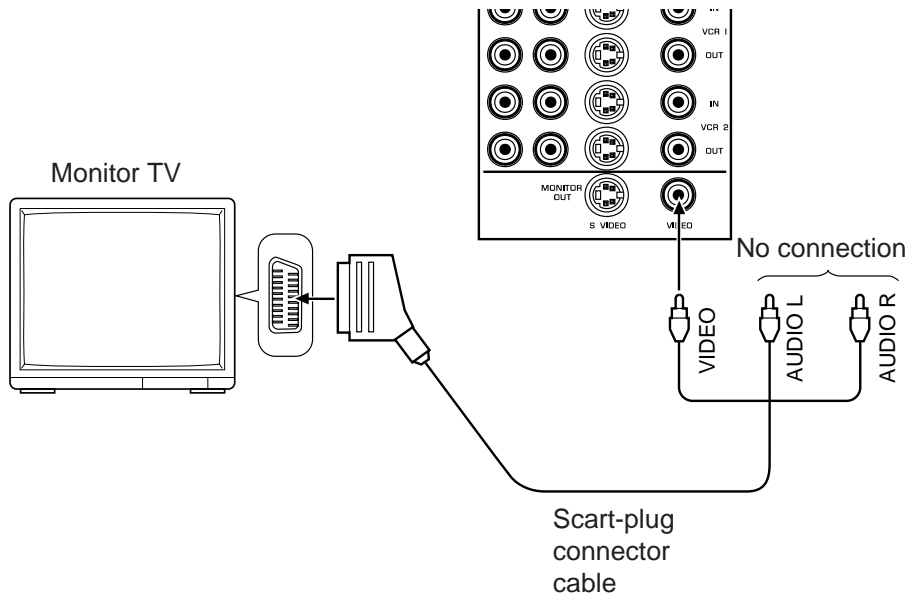

CONNECTING SPEAKER SYSTEMS

Connect the SPEAKERS terminals to your speakers with wire of the proper gauge, cut as short as possible. If the connections are faulty, no sound will be heard from the speakers. Make sure that the polarity of the speaker wires is correct, that is, + and – markings are observed. If these wires are reversed, the sound will be unnatural and will lack bass. Do not let the bare speaker wires touch each other or any other metal part as this could damage this unit and/or speakers.

NOTE: Use speakers with the specified impedance shown on the rear of this unit.

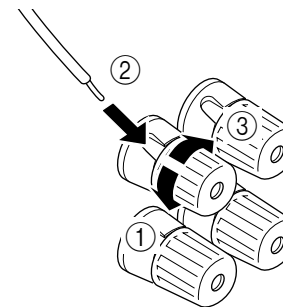

Red: positive (+)
Black: negative (-)

- ① Unscrew the knob.
- ② Insert the bare wire.
[Remove approx. 5mm (1/4") insulation from the speaker wires.]
- ③ Tighten the knob and secure the wire.

NOTE: Banana Plug connections are also possible (Australia and General models only). Simply insert the Banana Plug connector into the corresponding terminal.

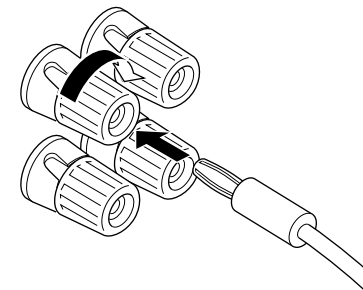

CONNECTING THE MAIN SPEAKERS TO THIS UNIT

Connect the MAIN speakers to the MAIN speaker output terminals of this unit. Make sure that the jumper bars between the PRE OUT and MAIN IN jacks on the rear panel are in place. It is also possible to use an external power amplifier if more power is desired. In this case, remove the jumper bars and connect the PRE OUT jacks to the INPUT jacks of a stereo power amplifier with a stereo pin cable—making sure to connect the left and right channels correctly. Connect the MAIN speakers to the speaker output terminals of the power amplifier.

NOTE: If an external amplifier is used for the main speakers, it is recommended to use the MAIN speaker terminals of this unit for the rear effect speakers. Connect the REAR output jacks to the MAIN IN jacks with a pin cord. This combination is highly upgraded and ideal for the division of sound quality, because the rear channel output of the Audio/Video system is equally important as the center channel.

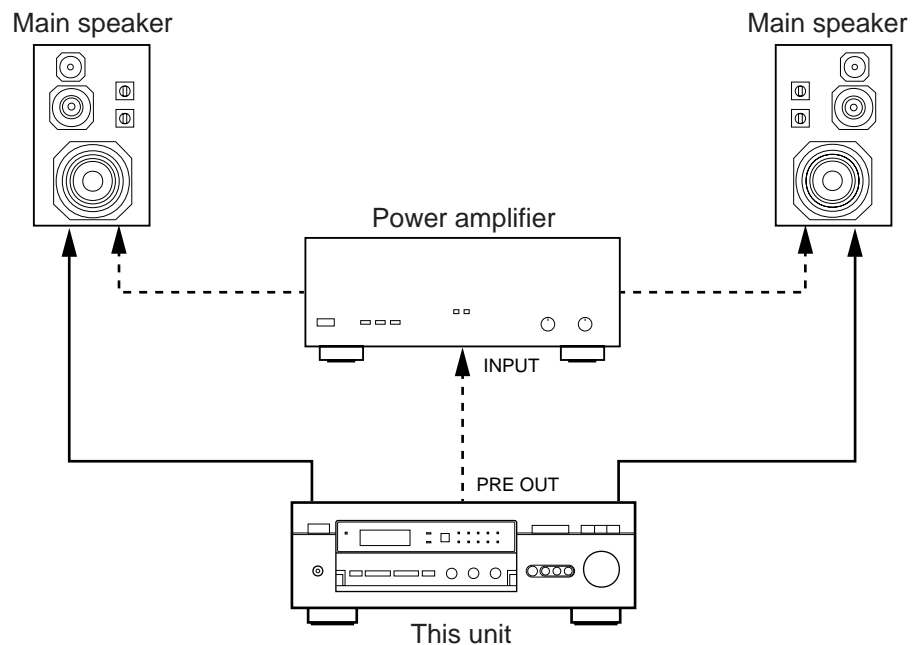

CONNECTING THE EFFECT SPEAKERS AND THE CENTER SPEAKER(S) TO THIS UNIT

Connect the FRONT effect speakers to the FRONT effect speaker output terminals of this unit.

If the FRONT effect speakers are not used, the FRONT MIX switch should be set to "ON".

Connect the REAR effect speakers to the REAR effect speaker output terminals of this unit.

Connect the CENTER speaker to the CENTER speaker output terminals. If you will be using one CENTER speaker, connect it to either the A or B terminals and set the CENTER speaker impedance switch to "A OR B" (bottom position). If using two CENTER speakers, connect them to the A and B terminals, and set the switch to "A + B" (top position). If, however, you will not be using a CENTER speaker, be sure to set the Center Mode to "PHNTM" (phantom). (See page 26.)

NOTE: The speaker connections above are fine for most applications. If for some reason, however, you wish to use an external power amp for any or all of the effect and center channels, connect the line level output jack(s) for each channel to the INPUT jacks of the external amp and connect the corresponding speaker pair to the speaker terminals of the external amp.

NOTE: If the pin plug is inserted in the FRONT/REAR output jacks, the speaker output from the built-in amplifier will be cut off.

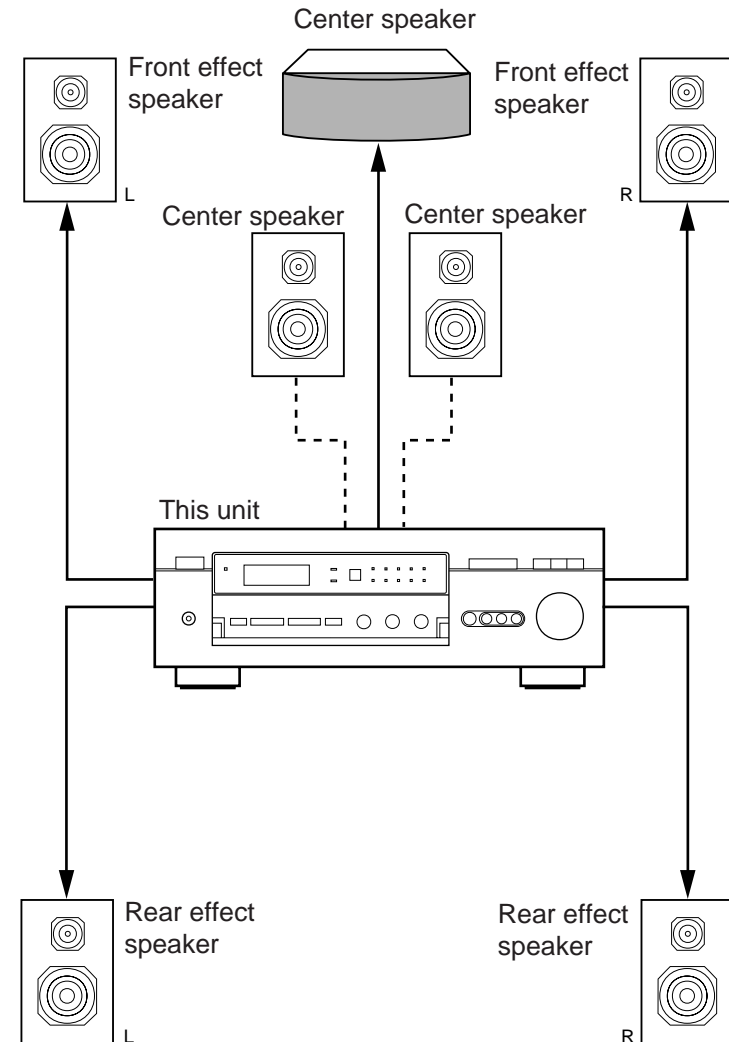

ADDING A SUBWOOFER

You may wish to add a subwoofer to reinforce the bass frequencies.

This unit provides a line-level subwoofer output, which contains only the frequencies under 200 Hz from the main and center channels. Connect the LOW PASS jack to the INPUT jack of the subwoofer amplifier, and connect the speaker terminals of the subwoofer amplifier to the subwoofer.

With some subwoofers, including the Yamaha Active Servo Processing Subwoofer System, the amplifier and subwoofer are in the same unit.

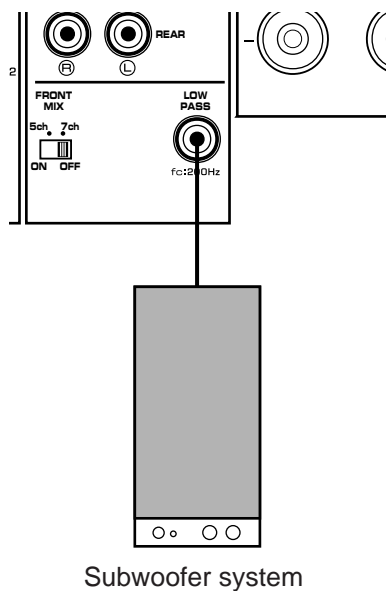

1-3. CONTROLS & ADJUSTMENTS

FRONT PANEL

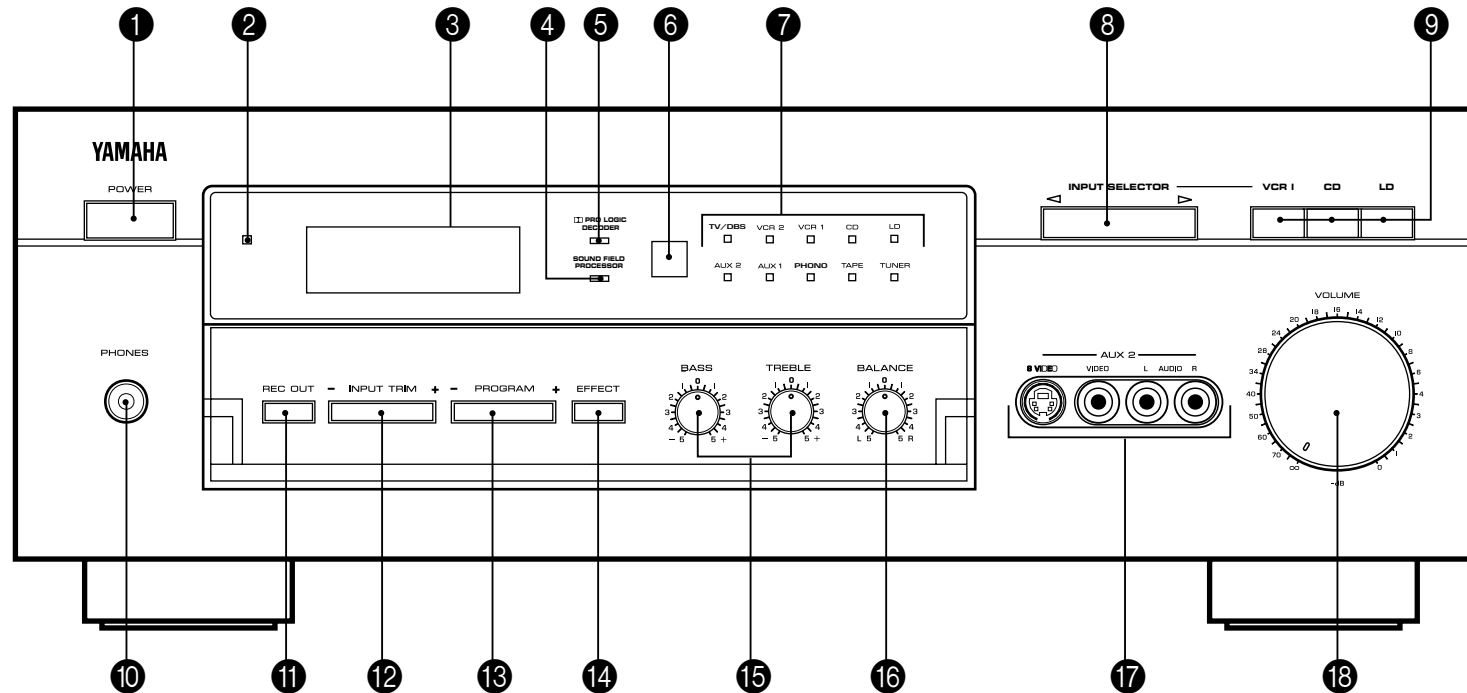

- 1** Power Switch
 * STANDBY Mode
 While the power is on, pressing the POWER key on the remote control unit switches the unit to the STANDBY mode. (In this mode, the power indicator is half illuminated.)
- 2** Power Indicator
 Lights up while the power is on.
- 3** Display Panel
 Shows program names, parameters and information about other various settings and adjustments.
- 4** SOUND FIELD PROCESSOR Indicator
 Lights up while the built-in Sound Field Processor is being activated.
- 5** PRO LOGIC DECODER Indicator
 Lights up while the built-in Dolby Pro Logic Surround Decoder is being activated.

- ⑥ Remote Control Sensor
Signals from the remote control unit are received here.
- ⑦ Input Source Indicators
Shows the currently selected input source by lights up the corresponding indicator.
- ⑧ Input Selector Switch
Sequentially selects the input source that you want to listen to and/or watch in the ◀ or ▶ direction. The indicator corresponding to the selected input source lights up. The selected input source is also shown by the display panel and the monitor screen (When the monitor is on).
- ⑨ Input Selector Switches for VCR 1, CD and LD
Directly selects VCR 1, CD or LD as the input source.
- ⑩ Phones Jack
Plug in headphones here for private listening. If the FRONT MIX and EFFECT switches are on, the effect channels will be heard along with the main channels. Otherwise the main channels only will be heard.
- ⑪ Rec Out Switch
Used to select the source to be recorded to tape deck or VCR independent of the selection of input source. When pressed, the indicator corresponding to the currently selected source to be recorded flashes. While an indicator is flashing, you can change the selection of the source to be recorded with the input selector switches. The selected source is also shown by the display panel and the monitor screen (when the monitor is on).
- ⑫ Input Trim Control
Adjusts the input level of each source respectively.
- ⑬ Program Selector
Sequentially selects the digital sound field processing programs in the + or – direction.
- ⑭ Effect Switch
Normally ON, this switch can be turned OFF to disable output from the center and effect speakers so that the sound becomes normal 2-channel stereo.
- ⑮ Bass and Treble Controls
Adjust the sound to match your tastes. Can also be used to compensate for room acoustics. Defeated in the center position.
- ⑯ Balance Control
Adjusts the left and right output volume to the Main Speakers to compensate for sound imbalance caused by speaker positions or listening room conditions.
- ⑰ Auxiliary Input Jacks (AUX 2)
Connect an auxiliary video or audio input source equipment such as a camcorder to these jacks. If the connected video equipment has a S video output terminal, connect it to the S VIDEO jack to obtain a high resolution picture. The source connected to these jacks can be selected by the input selector switch.
- ⑱ Master Volume Control
Simultaneously controls signal level at all outputs: front effect, main, rear effect, center, and subwoofer. (This does not affect TAPE REC OUT level.)

REMOTE CONTROL UNIT

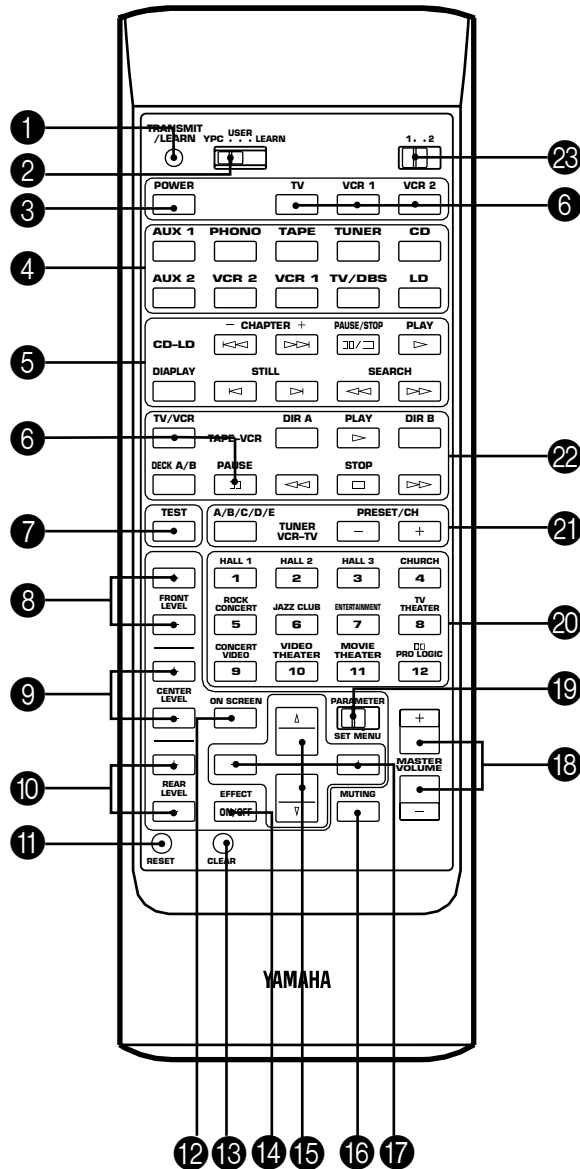

- 1** Transmit/Learn Indicator
In LEARN mode, lights to indicate that the key just pressed is ready for learning input. In USER mode, blinks when a learned key is pressed to show that a control signal has been sent to your equipment.
- 2** YPC/USER/LEARN Switch
Set to YPC for operating this unit and Yamaha Audio/Video units. Set to USER for using learned key functions. Set to LEARN for learning new control functions. (See page 38.)
("YPC" is the abbreviation of YAMAHA Preset Code.)
- 3** Power Key
Turns the POWER on mode to the STANDBY mode and vice versa.
- 4** Input Selector Keys
Select the input source.
- 5** CD/LD Function Keys
Operate functions on your Yamaha CD player and LD player. When the 1/2 Switch is set to 1, they operate the CD player, and when set to 2, they operate the LD player.
- 6** Blank Keys
Have no preset functions, so are used for learning other remote controller's functions only.
- 7** Test Switch
When pressed, sends a signal to the main left, center, main right, and rear effect speakers in turn, and when pressed once again, sends a signal to the main and front effect speakers in turn for easy comparison of level settings.

- 8 Front Level +/- Keys
Increase (+) or decrease (-) the volume level of the front effect speakers.
- 9 Center Level +/- Keys
Increase (+) or decrease (-) the volume level of the center speaker(s).
- 10 Rear Level +/- Keys
Increase (+) or decrease (-) the volume level of the rear effect speakers.
- 11 Reset Button
Press this button to “reset” the internal microcomputer which controls remote control operations. Microcomputer “reset” is necessary when the remote control freezes.
* Pressing the RESET button will not erase learned functions.
- 12 On Screen Display Key
Changes the type of display showing the program name and parameters, or information about various settings and adjustments on the connected monitor’s screen.
Whenever pressed, the screen changes to a full display, a simple display and no display in turn.
- 13 Clear Button
Used in USER or LEARN mode to erase a learned function. (See page 39.)
- 14 Effect On/Off Key
Cuts off the sound’s output from the front, rear effect and center speakers. To restore the output from those speakers, press this key again.
- 15 Parameter Select Keys
Select DSP program parameters, or titles of the items in the SET MENU mode.
- 16 Muting Key
Mutes the master volume level by 20 dB. While muting, the indicator on the master VOLUME control flashes on and off continuously.
- 17 Parameter +/- Keys
Edit DSP program parameters or used for settings and adjustments in the SET MENU mode.
- 18 Master Volume +/- Keys
Increase (+) or decrease (-) the master volume level.
- 19 Parameter/Set Menu Switch
When set to the PARAMETER position, the Parameter Select Keys and Parameter +/- Keys will select and edit DSP program parameters. When set to the SET MENU position, the Parameter Select Keys and Parameter +/- Keys are used for settings and adjustments in the SET MENU mode.
- 20 Program Select Keys (1 through 12)
Select DSP programs 1 through 12.
- 21 Tuner Function Keys
Operate Yamaha tuner functions.
- 22 Tape Deck Function Keys
Operate Yamaha tape deck functions.
- 23 1/2 Switch
When the YPC/USER/LEARN Switch is set to YPC, this switches the CD/LD Function Keys to keys for use with either the CD player or LD player. (“1” for the CD player and “2” for the LD player.) When the YPC/USER/LEARN Switch is set to USER or LEARN, this switch selects the group 1 or 2 of the learnable function keys. (See page 38.)

1-4. ADJUSTMENT

MAIN/CENTER/EFFECT SPEAKER LEVEL BALANCE ADJUSTMENT

This operation uses an internal test-tone generator for balancing the levels of the main, center and effect speakers.

1. Depress the TEST switch on the remote control so that “TEST DOLBY SUR.” appears on the display panel to enter test mode. A hiss-like calibration signal should be heard from the left main speaker, center speaker(s), right main speaker and rear effect speakers in turn (see diagram). Adjust the master VOLUME to a normal listening level.

* The state of test-tone output is shown by the display panel and the monitor screen. (On the monitor screen, it is shown by an image of audio listening room.) This is convenient for adjusting each speaker level.

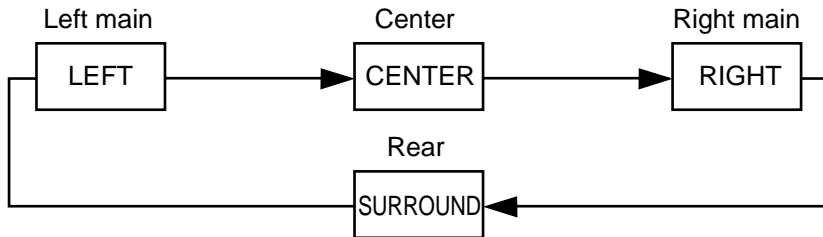

2. Adjust the center and rear level by using the CENTER and REAR LEVEL +/- keys on the remote control so that the sound coming from the corresponding speakers seems to be at the same level as that from the main speakers when you are at a normal listening position. If there is insufficient volume from the effect speakers, you may decrease the main speaker volume level by setting the MAIN LEVEL switch on the rear panel to “-10 dB”, and adjust the center and rear level again. Volume controls on external power amplifiers may also be adjusted if necessary to achieve proper balance.

3. For the front effect speaker level adjustment, depress the TEST switch on the remote control again so that “TEST DSP” appears on the display panel. A calibration signal should be heard from the main speakers and the front effect speakers in turn (see diagram).

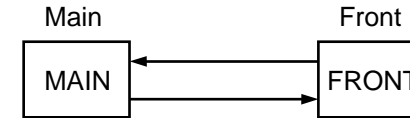

4. Adjust the front level by using the FRONT LEVEL +/- keys on the remote control so that the speaker volume is the same as that of the main speakers.

NOTE: If not using a center speaker, be sure to set the CENTER MODE to the PHNTM (phantom) position. You will then hear the center channel test tone from the left and right main speakers.

When this adjustment is finished, press the TEST switch once again.

NOTE: Once you have completed these adjustments, use only VOLUME control of this unit or MASTER VOLUME keys of the remote control unit to adjust the whole listening volume. Do not change any other volume setting in the system.

INPUT LEVEL ADJUSTMENT

This adjustment is important for obtaining the best performance from the internal circuits of this unit. The optimum input level of this unit is pre-adjusted on the basis of the CD source level. This adjustment should be performed on all input sources in your system respectively, so that their levels match the CD source level as closely as possible.

1. Select the CD source.

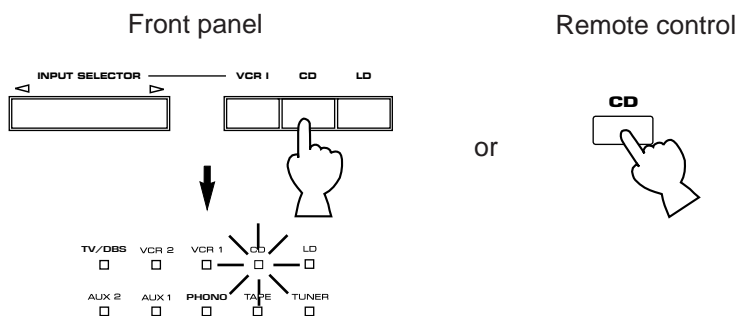

2. Play the source.

3. Increase the setting of the master VOLUME control to a convenient listening level (you will use this as your "reference" level).

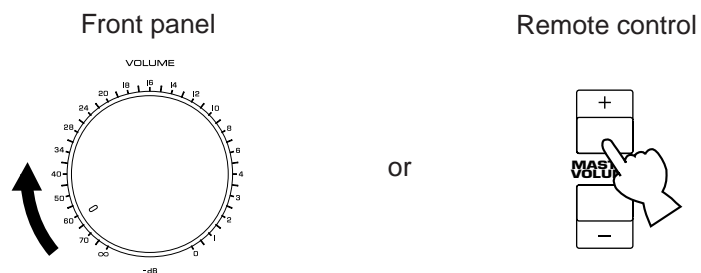

4. Select any other source in your system (VCR, tuner, etc.) and play that source.

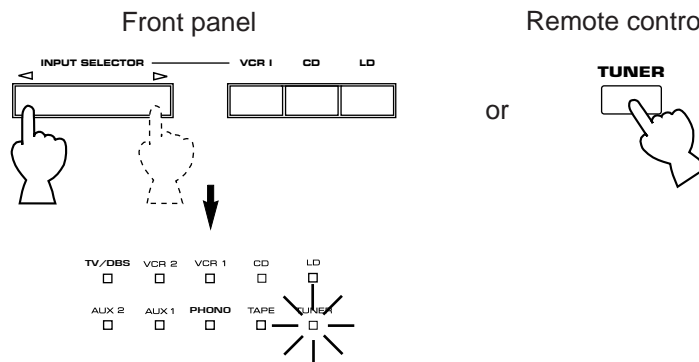

5. Adjust the level of the source to be approximately equal to your CD player's "reference" level by using the INPUT TRIM control.

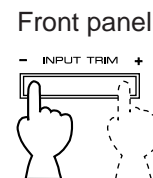

- * This adjustment can also be done with the remote control unit. For using the remote control unit, refer to "5. Input level adjustment (INPUT LVL TRIM)" on page 27.

6. In the same way, adjust levels of other sources.

NOTE: The adjustments will be saved until it is readjusted.

OTHER IMPORTANT SETTINGS AND ADJUSTMENTS IN THE “SET MENU” MODE

Make the following five types of settings and adjustments before enjoying audio and video sources. Note that these settings and adjustments cannot be done without monitoring the display information (or the information displayed on the monitor screen).

1. CENTER MODE
2. CENTER GEQ
3. PARAMETER INIT
4. MEMORY GUARD
5. INPUT LVL TRIM

METHOD OF SETTING AND ADJUSTMENT

As described on page 6, you can make these settings and adjustments watching the information displayed on the monitor screen (or superimposed over the video image). So, first turn the monitor on.

1. Set the PARAMETER/SET MENU switch to the SET MENU position on the remote control unit.

Remote control

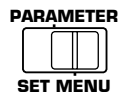

2. Select the item (title) on which you will make a change.

Remote control

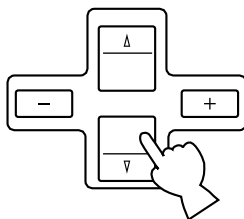

3. Select any desired position or edit parameters on the item.

Remote control

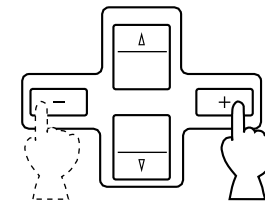

In the same way, make a setting or adjustment on any other item.

DESCRIPTIONS OF THE ITEMS

1. Selecting Center Mode (CENTER MODE NRML/WD/PHNTM)

In Normal (NRML) position, any frequency below 100 Hz will be divided between the main left and main right speakers. For this reason even a speaker smaller than the main left and right speakers can obtain a sufficient effect.

In Wide (WD) position, all range of frequencies for the center-channel are output to the center speaker. Select this position if a high quality center speaker is being used.

If not using the center speaker(s), be sure to select Phantom (PHNTM) position, and the audio signals for the center channel are output to the main speakers.

2. Adjusting Center Channel Graphic Equalizer (CENTER GEQ)

The built-in five band graphic equalizer is used to tailor, over a ± 6 dB range, the overall output frequency response of the center channel. The five bands cover the complete audible sound spectrum and are centered on 100 Hz, 300 Hz, 1 kHz, 3 kHz and 10 kHz frequencies. Adjustment should be done to each frequency individually.

Adjusting method

After selecting the item (title) in step 2 on the previous page, press the Parameter + or – key on the remote control to display the condition of the equalizer. Then select a frequency with the Parameter Select keys on the remote control and adjust its level with the Parameter +/- keys.

3. Initializing parameters on a DSP program (PARAMETER INIT)

You can initialize all parameter settings on a DSP program. Note that a DSP program (except CHURCH) has two sub-programs; all parameters on both sub-programs are initialized by this operation.

Initializing method

After selecting this item (title) in step 2 on page 26, press the Parameter + or – key to display the DSP program numbers (1 – 12). A program number whose parameters has been changed is marked with “*”. Press a Program Select Key corresponding to the program number of which parameters you want to initialize. When initialized, the “*” mark will disappear.

4. Locking DSP parameters and other adjustments (MEMORY GUARD)

If you wish to prevent accidental alteration to DSP parameters or other adjustments on this unit, select “ON”. In this position, they are locked and cannot be changed. The following functions on this unit can be locked by this operation.

- DSP parameters
- Other items in the “SET MENU” mode (CENTER MODE/CENTER GEQ/PARAMETER INIT/INPUT LVL TRIM)
- ON SCREEN display key
- INPUT TRIM control
- FRONT, REAR and CENTER level +/- keys
- TEST switch

5. Input level adjustment (INPUT LVL TRIM)

This function is provided for all input sources. It can be controlled from 0 to +6 dB in 2 dB steps. The sound level of each input source should be the same as that of regular CDs.

To adjust the input level, either press the INPUT TRIM control on the front panel (see page 25), or select the “5. INPUT LVL TRIM” in step 2 on page 26.

GENERAL OPERATION

2-1. PLAYING A SOURCE

1. Set the master VOLUME control to minimum.

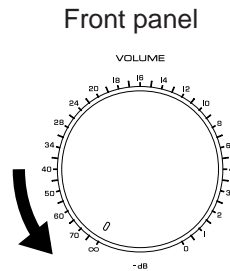

2. Turn the power on.

Front panel



or

Remote control



3. Select an input source.

(The selected source is shown by the display panel, the monitor screen and illumination of the corresponding input source indicator on the front panel.)

Front panel

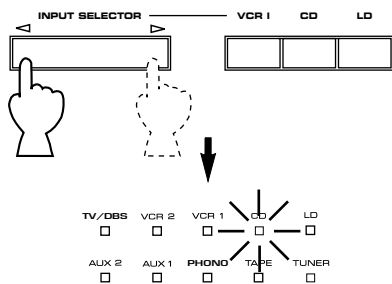

Remote control



- * On the front panel, VCR 1, CD or LD can be selected directly by pressing the corresponding switch.

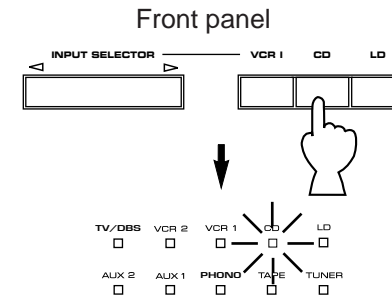

4. Play the source.

5. Increase the setting of the master VOLUME control to your listening level.

Front panel

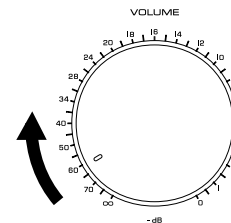

or

Remote control

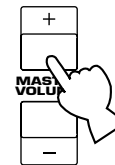

Adjust the BASS, TREBLE, BALANCE controls, etc., or select a desired sound field program. (See page 31.)

NOTE: If a different audio source is selected with the input selector keys on the remote control unit while enjoying a video source, the sound from the newly selected audio source is heard, but the picture from the video source can still be seen.

2-2. RECORDING A SOURCE TO AUDIO/VIDEO TAPE (OR DUBBING FROM A TAPE TO ANOTHER)

To record the input source

1. Press the REC OUT switch (so that “REC OUT…” appears on the display and the monitor screen).

Front panel



2. Within 5 seconds, select the “SOURCE” position with the input selector switch (so that “REC OUT SOURCE” appears on the display panel and the monitor screen).

Front panel

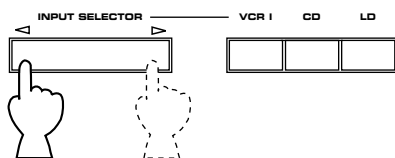

REC OUT SOURCE

3. Press the REC OUT switch (so that “REC OUT SOURCE” disappears from the display).
 - * The same result will be obtained after 5 seconds without any operation.

4. Select an input source to be played (and to be recorded).
(See page 28 for the method of input source selection.)

Front panel

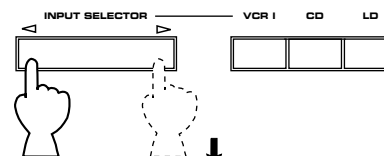

Remote Control

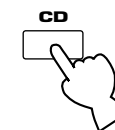

or



5. Play the source.
6. Set the tape deck or VCR used for recording to the recording mode.
 - * Adjust the recording level on the tape deck or VCR.

NOTE: To record picture from a video source and sound from another audio source, in step 4, first select a video source with an input selector switch on the front panel, and then select an audio source with the input selector keys on the remote control unit.

To record a source other than the input source

This unit has a function of selecting a source to be recorded to tape deck or VCRs independent of the selection of input source.

1. Press the REC OUT switch (so that “REC OUT…” appears on the display and the monitor screen).

Front panel



2. Within 5 seconds, select the source to be recorded with an input selector switch. (The indicator corresponding to the selected source to be recorded will flash.)

Front panel

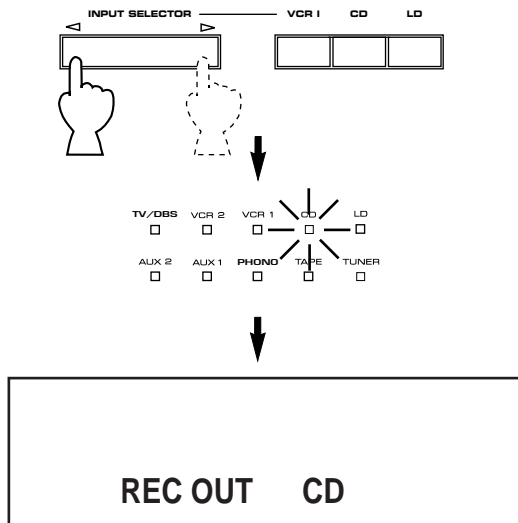

3. Press the REC OUT switch (so that the indicator corresponding to the selected source to be recorded stops flashing).
 - * The same result will be obtained after 5 seconds without any operation.

4. Play the source and confirm it by selecting it with an input selector switch and increasing the setting of the master VOLUME control.

Front panel

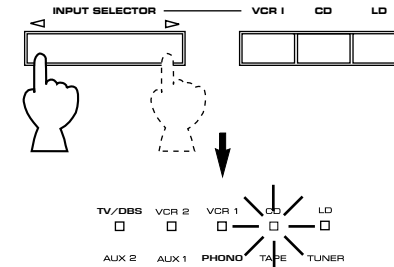

5. Set the tape deck or VCR used for recording to the recording mode.
 - * Adjust the recording level on the tape deck or VCR.
6. While recording a source, you can enjoy listening to and/or watching another source selected with the input selector switch.

Front panel

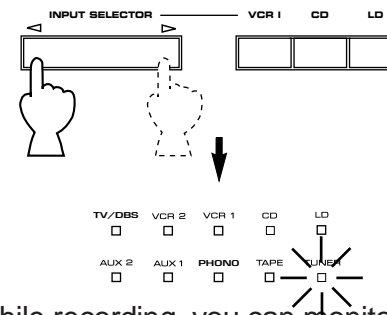

Remote control

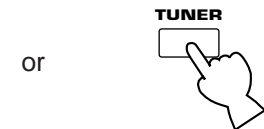

or

While recording, you can monitor the audio and/or video signals to be recorded by selecting the tape deck or VCR used for recording with the input selector switch.

NOTE: Adjusting the master VOLUME, BASS, TREBLE controls, etc., or selecting a sound field program has no effect on the material being recorded.

NOTE: Composite video and S video signals pass independently through this unit's video circuits. Therefore, when recording or dubbing video signals between two video cassette recorders, if your source VCR is connected to provide only S video (or only composite video) signals, you can record only a S video (or only a composite video) signal on your second VCR.

NOTE: Please check the copyright laws in your country to record from records, compact discs, radio, etc. Recording of copyright material may infringe copyright laws.

If you watch a video software that uses scramble or encoded signals to prevent it from being dubbed, there may be a case that display information superimposed on the picture and/or the picture itself is disturbed due to those signals.

2-3. DIGITAL SOUND FIELD PROGRAMS

This unit has 12 programs for digital sound field processing, 7 from actual acoustic environments from around the world, and 5 programs for Audio/Video sources including sources encoded with Dolby Pro Logic surround. Many of the programs contain various parameters that can be adjusted to the listener's taste.

2-4. SELECTING SOUND FIELD PROGRAMS

1. Set the PARAMETER/SET MENU switch on the remote control to the PARAMETER position.

Remote control

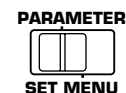

2. Select the desired sound field program by pressing the PROGRAM selector on the front panel or by using the Program Select keys on the remote control.

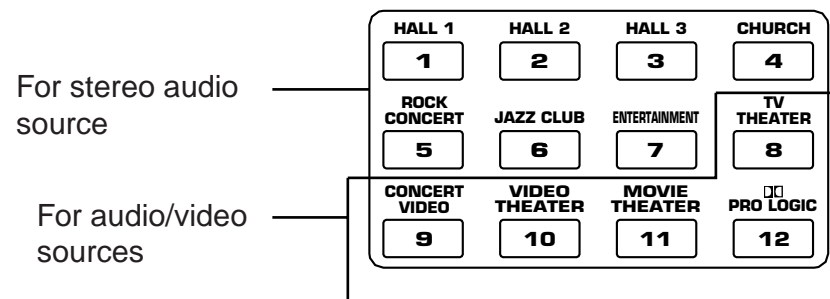

3. All sound field programs except CHURCH have two “sub-programs” (see “2-7. DESCRIPTIONS OF THE SOUND FIELD PROGRAMS”). The sub-programs are selected using the Parameter +/- keys on the remote control unit. The CONCERT HALL 1 program, for example, contains the sub-programs “Hall A in Europe” and “Hall B in Europe”. When the CONCERT HALL 1 program is first selected, the “Hall A in Europe” sub-program will be selected and displayed on the front panel. To select “Hall B in Europe”, press the Parameter + or – key. To return to Hall A in Europe, press the Parameter + or – key again. The same selection procedure applies to all other programs.

The sub program selection can also be done simply by pressing the corresponding Program Select key on the remote control.

* If you will change the sub-program by pressing a Program Select key while watching the monitor screen, press a key as described below;

If the display type is a full display, press the key of the corresponding program once. If the display type is a simple display or no display, press the key twice.

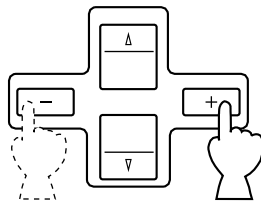

2-5. MUTING THE EFFECT SOUND

The EFFECT switch on the front panel and the EFFECT ON/OFF key on the remote control unit make it simple to compare the normal stereo sound with the fully processed effect sound.

To mute the effect sound and monitor only the main sound, press the EFFECT ON/OFF key or the EFFECT switch. Press the EFFECT ON/OFF key or the EFFECT switch a second time to restore normal operation.

2-6. SUPERIMPOSED VIDEO PROGRAM/PARAMETER DISPLAY

You can select program names and edit parameters watching their data displayed on your video monitor screen and superimposed over the video image as described on page 6.

1. Turn your monitor on, and press the ON SCREEN display key on the remote control unit to call the full display mode.
2. The current program name and its parameters will be displayed on the monitor screen. The arrow-shaped cursor points to the currently selected parameter. Parameters are selected and edited using the Parameter Select keys and +/- keys. (See page 41 for details.)

2-7. DESCRIPTIONS OF THE SOUND FIELD PROGRAMS

The following list gives brief descriptions of the sound fields produced by each of the DSP programs. Keep in mind that most of these are precise digital recreations of actual acoustic environments. The data for them was recorded at the locations described using sophisticated sound field measurement equipment.

*** The channel level balance between the left rear effect speaker and the right rear effect speaker may vary depending on the sound field you are listening to. This is due to the fact that most of these sound field recreations are actual acoustic environments.**

1. CONCERT HALL 1

Hall A in Europe: This is a large fan-shaped concert hall in Munich which has approximately 2500 seats. Almost the whole interior is made of wood. There is relatively little reflection from the right and left walls, and sounds spread finely and beautifully.

Hall B in Europe: This is a large shoe-box type concert hall with approximately 2500 seats. Almost the whole interior except the ceiling is made of wood, including mahogany reflective panels. Special reflective paneling above the stage produces strong frontal reflections which tend to reinforce the direct sound from the stage. This hall has a very solid, powerful sound.

2. CONCERT HALL 2

Hall C in Europe: A classic shoe-box type concert hall with approximately 1700 seats. Pillars and ornate carvings create extremely complex reflections. Those reflections and the reflections from all directions of the hall produce a very full, rich sound.

Hall D in U.S.A.: This is a large 2600-seat concert hall in the United States which features a fairly traditional European design. The interior is relatively simple, suggesting an American taste. Sound of the middle and high frequencies are richly and beautifully reproduced.

3. CONCERT HALL 3

Hall E in Europe: A classic large shoe-box type concert hall with approximately 2200 seats. It has a circular stage and seats located behind the stage.

Live Concert: A large round concert hall with a rich surround effect. Pronounced reflections from all directions emphasize the extension of sounds. You will experience the sound field with a great deal of presence sitting at about the center position near the stage. This sound field is also effective for karaoke. This is because you feel as if you are standing on a real stage.

4. CHURCH

A church in Tokyo shaped like a cross. There is the altar at the upper side of the "cross", and a pipe organ at the opposite side (the lower side of the cross). It is a very unique shape with walls all leaning inside, and pillars standing by the side of walls only. The sound field has moderate reverberations of which time is 2.5 seconds.

5. ROCK CONCERT

The Roxy Theatre: The ideal program for lively, dynamic rock music. The data for this program was recorded at LA's "hottest" rock club.

Arena: A big, powerful sound suited to rock music.

6. JAZZ CLUB

Village Gate: A jazz club in New York. It is in a basement and has a relatively spacious floor area. The reflection pattern is similar to that of a small hall.

Cellar Club: This is a small, cozy jazz club with a low ceiling. The sound is very close and intimate.

7. ENTERTAINMENT

Stadium: This program gives you long delays between direct sounds and effect sounds, and extraordinarily spacious feel of a large stadium.

Disco: This program recreates the acoustic environment of a lively disco in the heart of a very lively city. The sound is dense and highly concentrated. It is also characterized by a high-energy, “immediate” sound.

8. TV THEATER

Drama: The data of the sound field of a relatively narrow space is used for the front presence side. A moderately sized spatial sound field without excessive sound extension and reverberations gives reality to the characters in a drama.
The data of the sound field of an opera house is used for the rear surround side. In a stereo program, background music is reproduced more beautifully with much depth, enhancing sound effects on the drama. It's natural sound effect will not make you tired from long watching.

Variety/Sports: Though the front presence side of the sound field is relatively narrow, the rear surround side employs the sound environment of a large concert hall. With this program, you can enjoy watching various TV programs such as the news, variety shows, music programs or sports programs. In a stereo broadcast of a sports game, the commentator is oriented at the center position, and the shouts and the atmosphere in the stadium spreads on the surround side, however, spreading of them to the rear side is properly restrained.

9. CONCERT VIDEO

Classical/Opera: This program provides excellent depth of vocals and overall clarity, restraining excessive reverberation. For opera, the orchestra pit and the stage are ideally combined, letting you feel a full presence sound. The rear surround side of the sound field is relatively moderated, however, it reproduces beautiful sound by the use of the data of a concert hall. You will not be tired from long watching of an opera.

Pop/Rock: This program produces an enthusiastic atmosphere and lets you feel that you are in the midst of the action, as if attending an actual jazz or rock concert. The indirect sound constituent spreads on the surround side of the sound field by the use of data of a large round hall for the surround side, so the image space around the screen and the sound space are fully expanded.

10. VIDEO THEATER

Fantasy: Powerful reverberations on the front presence side of the sound field adds depth to the image, so expanding the image space. On the rear surround side, sounds are reproduced lightly but vividly. The sound field of this program matches image effects of animated films regardless of the genre. Conversations, sounds and sound effects are reproduced with vitality by this program. A source in stereo will obtain more effect, letting you steep yourself in a fantastic world of animations.

Classic Film: This program is for reproducing monaural video sources (old movies etc.). Monaural sounds are reproduced with much presence by the front presence side of the sound field and optimum reverberation effect. The use of the center speaker makes conversations more audible, obtaining a pleasant mix of conversations and picture.

11. MOVIE THEATER

Ideal for reproducing video discs, video tapes and similar sources which are Dolby Surround encoded and bear the "DOLBY SURROUND" logo.

70 mm Adventure: This program is ideal for precisely reproducing the sound design of the newest movies. The sound field is made according to the design of the newest movie theaters, so the reverberations of the sound field itself are restrained as much as possible. The three dimensional feeling of the sound field is emphasized, and dialog is precisely oriented on the screen. You can enjoy watching Sci-Fi, adventure movies, etc. with this program.

70 mm General: This program is for reproducing sounds on a 70 mm multi-track film, and characterized by a soft and extensive sound field. The front presence side of the sound field is relatively narrow. It spatially spreads all around and toward the screen, restraining echo effect of conversations without losing clarity. For the surround side, the data of the sound field of an opera house is used on an enlarged scale, so the harmony of music or chorus sounds beautifully in a wide space at the rear of the sound field.

12. DOLBY PRO LOGIC SURROUND

Reproduces video discs, video tapes and similar sources which are Dolby Surround encoded and bear the "DOLBY SURROUND" logo.

Normal: The digital Dolby Pro Logic decoder reproduces sounds and sound effects of a source encoded in Dolby Surround. The realization of a highly efficient decoding process improves crosstalk and channel separation and makes sound positioning smoother and more precise.

Enhanced: This program ideally simulates the multi-surround speaker systems of the 35 mm film theater. Surround signals by the Dolby Pro Logic decoder are processed on the surround side of the sound field based on the data of the sound field of a shoe-box hall. The surround effects produced by this sound field folds the viewer naturally from the rear to the left and right and toward the screen.

NOTE: The Dolby Pro Logic Surround system is designed to be used with program material (mainly videotaped movie soundtracks) encoded with the Dolby Surround system.

NOTE: If the main and center channel sound is considerably altered by overadjustment of the BASS or TREBLE controls, the relationship with the rear channels may produce an unnatural effect.

2-8. REMOTE CONTROL “LEARNING” FUNCTION

The remote control unit, in addition to controlling the most commonly used functions of the main unit and other connected Yamaha audio and video equipment, has a sophisticated “learning” function that allows it to control other equipment in your system or other household appliances equipped with infrared remote control receivers. By setting the YPC/USER/LEARN switch on the remote control unit to “LEARN”, all keys will turn into “learnable function keys”, each capable of “learning” a different remote control function. Also, each key can learn two different functions by switching the learning group (1 or 2) with the 1/2 switch. However, as for the keys shaded in the following figure, the PARAMETER/SET MENU switch will select the learning group number (1 or 2) instead of the 1/2 switch.

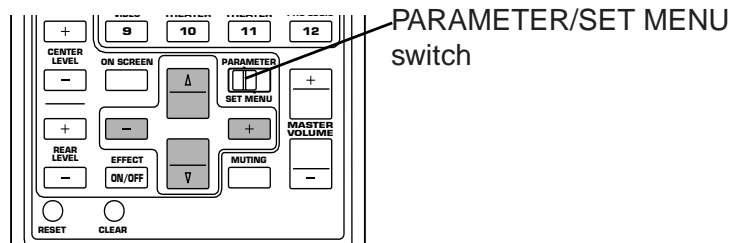

Learning a New Remote Control Function

1. Select the learning group number (1 or 2) by using the 1/2 switch.
2. Set the YPC/USER/LEARN switch to “LEARN”.
3. Aim the infrared transmitter window of the other remote control unit.

4. Press the key that is to have a new function assigned to it. The TRANSMIT/LEARN indicator will light up.
5. Press and hold down the button on the other remote control unit corresponding to the new function to be learned. Hold the button down until the TRANSMIT/LEARN indicator is extinguished. The function has now been learned.

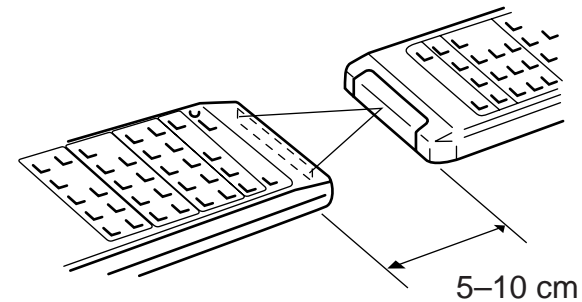

6. Repeat steps 4 and 5 to learn additional functions.
7. Set the YPC/USER/LEARN switch to “USER”. Pressing the learned key will now perform the assigned function. Provided user program sheets should be used to record the functions learned by the various keys.

NOTE: The originally preset function of a key is still available in the USER position if the key does not learn a new function.

NOTE: If there is no more room in the memory area for a function to be learned, the TRANSMIT/LEARN indicator will flash on and off eight times. In this case, even if some keys are not occupied with functions from other remote control units, no further learning is possible.

The function learned by any key can be easily changed by repeating the learning process with a different function. It is also possible to erase learned functions so that the keys return to the originally preset functions.

Erasing a Learned Function

1. Set the YPC/USER/LEARN switch to “USER”.
2. Use the point of a pencil or other similar object to press and hold the CLEAR button.
3. Press and hold the key whose function is to be erased until the TRANSMIT/LEARN indicator flashes on and off three times.

Erasing All Learned Functions

1. Set the YPC/USER/LEARN switch to “LEARN”.
2. Use the point of a pencil or other similar object to press and hold the CLEAR button.
3. Press and hold any key until the TRANSMIT/LEARN indicator flashes on and off seven times.

NOTE: All of the memorized functions will be retained while you replace the batteries. However, if no batteries are installed for a few hours, the memory will be erased and will have to be programmed again.

NOTE: There may occasionally be instances in which, due to the signal-coding and modulation systems employed by another remote control unit, that this remote control unit will not be able to learn its signals. In this case, the TRANSMIT/LEARN indicator will flash on and off eight times.

NOTE: When the remote control freezes, press the RESET button to “reset” the internal microcomputer which controls remote control operations. Pressing the RESET button will not erase learned functions.

CREATING YOUR OWN SOUND FIELDS

3-1. SELECTING AND EDITING PROGRAM PARAMETERS

WHAT IS A SOUND FIELD?

In order to explain the impressive functions of the DSP system, we need to first understand what a sound field really is.

What really creates the rich, full tones of a live instrument are the multiple reflections from the walls of the room. In addition to making the sound “live”, these reflections enable us to tell where the player is situated, and the size and shape of the room in which we are sitting. We can even tell whether it is highly reflective, with steel and glass surfaces, or more absorbent—wood panels, carpeting and curtains.

THE ELEMENTS OF A SOUND FIELD

In any environment, in addition to the direct sound coming straight to our ears from the player’s instrument, there are two distinct types of sound reflections that combine to make up the sound field:

(1) Early Reflections. Reflected sounds reach our ears extremely rapidly (50 ms — 100 ms after the direct sound), after reflecting from one surface only—for example, from the ceiling or a wall. These reflections fall into specific patterns as shown in the diagram on page 42 for any particular environment, and provide vital information to our ears. Early reflections actually add clarity to the direct sound.

(2) Reverberations. These are caused by reflections from more than one surface—walls, ceiling, the back of the room—so numerous that they merge together to form a continuous sonic “afterglow”. They are non-directional, and lessen the clarity of the direct sound.

Direct sound, early reflections and subsequent reverberation taken together help us to determine the subjective size and shape of the room, and it is this information that the DSP system reproduces in order to create sound fields.

If you could create the appropriate early reflections and subsequent reverberations in your listening room, you would be able to create your own listening environment. The acoustics in your room could be changed to those of a concert hall, a dance floor, or virtually any size room at all. This ability to create sound fields at will is exactly what Yamaha has done with the DSP system.

DSP programs consist of some parameters to determine apparent room size, reverberation time, distance from you to the performer, etc. In each program, those parameters are preset with values precisely calculated by Yamaha to create the sound field unique for the program. It is recommended to use DSP programs without changing values of parameters, however, this unit also allows you to create your own sound fields. Starting with one of the built-in programs, you can adjust those parameters. Even if power is turned off, your custom sound fields will remain in the DSP system’s memory for about two weeks. The following pages detail how to make your own sound fields.

In addition to the “TYPE” parameter which selects the sub-programs within each sound field program (e.g. “Hall A in Europe” and “Hall B in Europe” for program 1, “CONCERT HALL 1”), each program also has a set of parameters that allow you to change the characteristics of the acoustic environment to create precisely the effect you want. These parameters correspond to the many natural acoustic factors that create the sound field you experience in an actual concert hall or other listening environment. The size of the room, for example, affects the length of time between the “early reflections”—that is, the first few widely spaced reflections you hear after the direct sound. The “ROOM SIZE” parameter provided in many of the DSP programs alters the timing between these reflections, thus changing the shape of the “room” you hear. In addition to room size, the shape of the room and the characteristics of its surfaces have a significant effect on the final sound. Surfaces that absorb sound, for example, cause the reflections and reverberations to die out quicker, while highly reflective surfaces allow the reflections to carry on for a longer period of time. The DSP parameters allow you to control these and many other factors that contribute to your personal sound field, allowing you to essentially “redesign” the concert halls and rooms provided to create custom-tailored listening environments that ideally match your mood and music.

Refer to “3-2. DESCRIPTIONS OF THE DIGITAL SOUND FIELD PARAMETERS” on page 42 for a description of what each parameter does, how it effects the sound, and its control range.

1. With the desired program selected, press the Parameter Select (▽) key on the remote control unit once. This will recall the next parameter after the program type. In the case of the CONCERT HALL 1 program, for example, this would be the INIT. DLY parameter. You can continue pressing the Parameter Select (▽) key to select other parameters in sequence. Press the Parameter Select (△) key to scroll upward through the parameter list.

2. When the desired parameter has been recalled, use the Parameter + (increment) and – (decrement) keys to change its value to create the effect you want. + increases the value of the selected parameter, and – decreases the value of the selected parameter. In both cases you can hold the key down for continuous incrementing or decrementing. The display will pause for a moment at the initial value of the parameter as a reminder. (On the monitor screen, * mark at the head of parameter name disappears at the initial value of the parameter.)

NOTE: Parameter edits made in this way will remain in effect even with power cut due to power failure or the power plug disconnected from the AC outlet for up to about two weeks, after which all parameters, as well as other adjustments or settings on this unit, will return to their initial values or conditions.

3-2. DESCRIPTIONS OF THE DIGITAL SOUND FIELD PARAMETERS

Not all of the following parameters are found in every program.

● ROOM SIZE

How it Affects the Sound:

Changes the apparent size of the music venue. The larger the value, the larger the simulated room will sound.

What it Does:

Adjusts the timing between the early reflections. Early reflections are the first group of reflections you hear before the subsequent, dense reverberation begins.

Control Range:

0.1 – 2.0

Standard setting is 1.0.

Changing this parameter from 1 to 2 increases the apparent volume of the room eight times (length, width, and height all doubled).

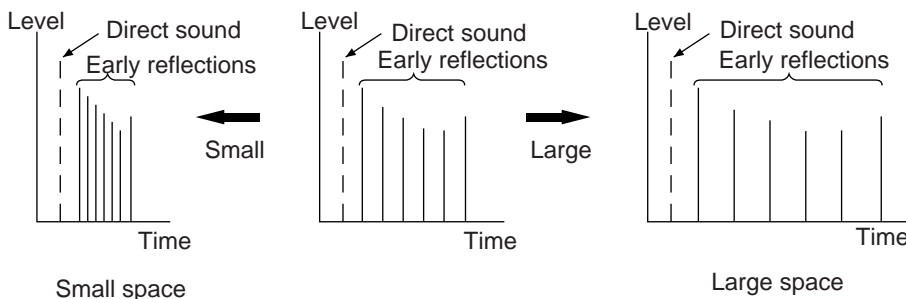

● INIT DLY (Initial Delay)

How it Affects the Sound:

Changes the apparent distance from the source sound.

Since the distance between a sound source and a reflective surface determines the delay between the direct sound and the first reflection, this parameter changes the location of the sound source within the acoustic environment.

What it Does:

Adjusts the delay between the direct sound and the first reflection heard by the listener.

Control Range:

1 – 49 milliseconds

For a small living room this parameter would be set for a small value. Large values for a big room. Larger values produce an echo effect.

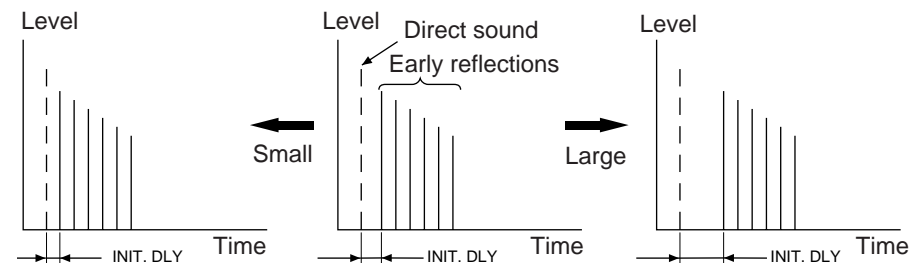

● LIVENESS

How it Affects the Sound:

This parameter changes the apparent reflectivity of the walls in the hall.

The early reflections from a sound source will lose intensity (decay) much faster in a room with acoustically absorbent wall surfaces than in one which has mostly reflective surfaces. A room with highly reflective surfaces in which the early reflections decay slowly is termed “live”, while a room with absorbent characteristics in which the reflections decay rapidly is termed “dead”. The LIVENESS parameter lets you adjust the early reflection decay rate, and thus the “liveness” of the room.

What it Does:

Changes the rate at which the early reflections decay.

Control Range:

0 – 10.

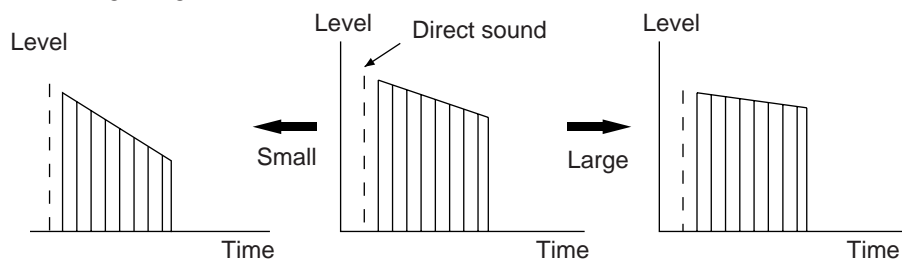

● REV. TIME (Reverberation Time)

How it Affects the Sound:

The natural reverberation time of a room depends primarily on its size and the characteristics of its inner surfaces. This parameter, therefore, changes the apparent size of the acoustic environment over an extremely wide range.

What it Does:

Adjusts the amount of time it takes for the level of the dense, subsequent reverberation sound to decay by 60 dB (@ 1 kHz).

Control Range:

1.0 – 5.0 seconds.

The reverb time in a small-to-medium size hall would be between 1 and 2, and in a large hall it is normally between 2 and 3.

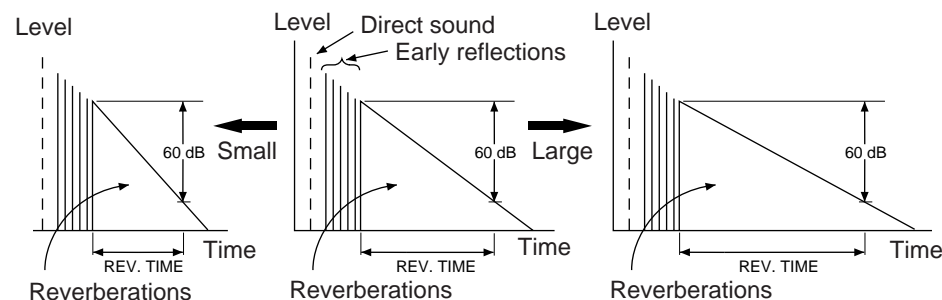

- **DIR. ENHANCEMENT (Directional Enhancement)**

This circuit emphasizes the position of sound. If this circuit is activated, the unity constituent of the input left and right channels (those signals which are common to the left and right channels) will be output from the center speaker, and the disparity constituent of the left and right signals (the difference between the left and right channels) will be output from the surround speakers.

Because the unity constituent signal determines localization, precise localization is obtained even though a listener is left or right of the ideal center listening position.

The primary sound field around the screen is obtained according to processing based on left, center and right speakers as the sound source. Also, with the processing of the surround sound source based on the disparity constituent (which includes most of the indirectional sound constituent), sound diffusion to the rear speakers is obtained. Therefore, directional enhancement is an especially effective processing option for vocal or operas.

With monaural sound sources, almost all sounds are output from the center speaker instead of the left and right main speakers.

Selectable levels:

OFF/MIN/MID/MAX

- **DOLBY PRO LOGIC (for MOVIE THEATER only)**

By adding the Dolby Pro Logic Decoder to the DSP effect, the full presence of a 70 mm film theater is reproduced without deteriorating the channel separation.

With monaural sound sources, almost all sounds are output from the center speaker instead of the left and right main speakers.

Selectivity:

ON/OFF

- **DELAY**

Adjusts the delay between the direct sounds (at the main left, center and main right channels) and the effect sounds (at the front effect and rear effect channels). The larger the value, the later the effect sounds are generated.

Control Range:

15 – 30 milliseconds

TROUBLESHOOTING

PROBLEM	POSSIBLE CAUSE	WHAT TO DO
Power does not come on.	AC cord not properly plugged in.	Carefully plug AC plug into outlet.
Hum.	Bad cable connection.	Firmly plug in all connection cables.
No sound.	Bad or incorrect input connection. Incorrect input source selection.	Check connections. Select the appropriate input source with the input selector switch.
No sound from the effect speakers.	The EFFECT switch is set off. The DOLBY PRO LOGIC program is being used with material not encoded with Dolby Surround.	Press the EFFECT switch to turn it on. Use a different sound field program.
No sound from the front effect speakers.	The FRONT MIX switch is set to "ON".	Set the FRONT MIX switch to "OFF".
No sound from the center speaker.	The center mode is in "PHNTM". Incorrect sound field program.	Select the appropriate center mode. Select the appropriate program.
The sound suddenly goes off.	The protection circuit has activated because of short circuit etc.	Turning the unit off and then on will reset the protection circuit.
The volume level cannot be increased, or sound is distorted.	The power to the component connected to the REC OUT jacks of this unit is off.	Turn the power to the component on.
DSP parameters or other settings on this unit cannot be changed.	The "MEMORY GUARD" function is set ON.	Turn the "MEMORY GUARD" OFF.
The sound field cannot be recorded.	It is not possible to record the sound field on a tape deck connected to this unit's TAPE REC OUT jacks.	
Noise from nearby TV or tuner.	This unit is too close to the affected equipment.	Move the unit further away from the affected equipment.
Continuous functions such as volume are learned, but operate only for a moment before stopping.	Learning process incomplete.	Be sure to press and hold the function key on the other remote control until the TRANSMIT/LEARN indicator is extinguished.
The sound is degraded when monitoring is performed by using the headphones connected to the compact disc player or cassette deck which are connected with this unit.	The power to this unit is off.	Turn the power to this unit on.
The remote control unit does not function properly.	Dead batteries. Wrong distance or angle. Direct sunlight or lighting (of an inverter type of fluorescent lamp etc.) is striking the remotecontrol sensor of the main unit.	Replace batteries. The remote control unit will function from a maximum range of 6 meters, no more than 30 degrees off-axis from the front panel. Change position of the main unit.
The remote control unit cannot learn a new function from another remote control unit.	Memory is full. There may occasionally be instances in which, due to the signal-coding and modulation systems employed by another remote control unit, that this remote control unit will not be able to learn its signals.	Erase unnecessary functions.

SPECIFICATIONS

Minimum RMS Output Power Per Channel

Main (20 Hz – 20 kHz 0.015% THD 8Ω/6Ω)	60W+60W/75W+75W
Center (20 Hz – 20 kHz 0.015% THD 8Ω/6Ω)	60W/75W
Front Effect (1 kHz 0.03% THD 8Ω/6Ω)	22W+22W/25W+25W
Rear Effect (1 kHz 0.03% THD 8Ω/6Ω)	22W+22W/25W+25W

DIN Standard Output Power Per Channel [Europe and Singapore models]

(1 kHz 0.7% THD 4Ω)	105W
---------------------------	------

IEC Power [Europe and Singapore models]

(1 kHz 0.015% THD 6Ω)	80W
-----------------------------	-----

Damping Factor

Main, Center (1 kHz 8Ω)	More than 100
-------------------------------	---------------

Input Sensitivity/Impedance (100W/8Ω)

CD/TUNER/TAPE/LD/TV·DBS/VCR/AUX	150 mV/47 kΩ
PHONO MM	2.5 mV/47 kΩ

Maximum Input Signal

CD/TUNER/TAPE/LD/TV·DBS/VCR/AUX (1 kHz 0.5% THD, EFFECT ON)	More than 2.3V
PHONO (1 kHz 0.01% THD)	More than 130 mV

Output Level/Impedance

REC OUT (Phono)	150 mV/1 kΩ
LOW PASS (fc=200 Hz) (EFFECT OFF)	4.0V/3.3 kΩ

Headphone Jack Rated Output/Impedance

Output Level (input 50 mV, RL=8Ω)	0.19V
Impedance	100Ω

Frequency Response (20 Hz – 20 kHz)

CD/TUNER/TAPE/LD/TV·DBS/VCR/AUX to MAIN L/R SP OUT	0±1.0 dB
--	----------

RIAA Equalization Deviation (20 Hz – 20 kHz)

PHONO MM	0±0.5 dB
----------------	----------

Total Harmonic Distortion

CD/TUNER/TAPE/LD/TV·DBS/VCR/AUX to SP OUT	
35W/8Ω, MAIN L/R, 20 Hz – 20 kHz	Less than 0.02%
10W/8Ω, FRONT L/R·REAR L/R, 1 kHz	Less than 0.3%
PHONO MM to REC OUT 1V, 20 Hz – 20 kHz	Less than 0.01%
Built-in amplifier	
35W/8Ω, MAIN L/R, CENTER, 20 Hz – 20 kHz	Less than 0.008%
10W/8Ω, FRONT L/R·REAR L/R, 20 Hz – 20 kHz	Less than 0.03%

Signal-to-Noise Ratio (IHF-A Network)

CD/TUNER/TAPE/LD/TV·DBS/VCR/AUX (Input Shorted 150 mV) (EFFECT OFF)	More than 96 dB
PHONO MM (Input Shorted 5 mV) (EFFECT OFF)	More than 86 dB

Residual Noise (IHF-A Network)

MAIN L/R SP OUT	Less than 150 μV
-----------------------	------------------

Channel Separation Vol –30 dB

CD/TUNER/TAPE/LD/TV·DBS/VCR/AUX Input 5.1 kΩ Terminated (EFFECT OFF) 1 kHz/10 kHz	More than 60 dB/45 dB
PHONO MM Shorted Vol. –30 dB (EFFECT OFF) 1 kHz/10 kHz	More than 65 dB/50 dB

Tone Control Characteristics (MAIN L/R)

Bass	
Boost/Cut	±10 dB (50 Hz)
Turnover frequency	350 Hz
Treble	
Boost/Cut	±10 dB (20 kHz)
Turnover frequency	3.5 kHz

Filter Characteristics (Highcut Filter)

LOW PASS (fc = 200 Hz)	6 dB/oct.
------------------------------	-----------

Audio muting

	–20 dB
--	--------

Video Section

Video Signal Type	
[Australia, Europe and U.K. models]	PAL
[Singapore Model]	NTSC
[General Model]	NTSC/PAL
Video Signal Level	1 Vp-p/75Ω
S-Video Signal Level	
Y	1 Vp-p/75Ω
C	0.286 Vp-p/75Ω
Maximum Input Level	More than 1.5 Vp-p
Signal-to-Noise Ratio	More than 50 dB
Monitor Out Frequency Response	5 Hz – 10 MHz, –3 dB

Power Supply

Australia model	AC 240V/50 Hz
Europe, U.K. and Singapore models	AC 230V/50 Hz
General model	AC 110/120/220/240V 60/50 Hz

Power Consumption 280W

AC Outlets

2 SWITCHED OUTLETS	
[General model]	100W max. total
1 SWITCHED OUTLET	
[Australia, Europe, U.K. and Singapore models]	100W max.
1 UNSWITCHED OUTLET	
[General model]	200W max.

Dimensions (W x H x D) 435 x 151.5 x 408.5 mm
 (17-1/8" x 5-15/16" x 16-1/16")

Weight 14.0 kg (30 lbs. 13 oz.)

* Specifications are subject to change without notice.

YAMAHA CORPORATION

YAMAHA ELECTRONICS CORPORATION, USA 6660 ORANGETHORPE AVE., BUENA PARK, CALIF. 90620, U.S.A.
YAMAHA CANADA MUSIC LTD. 135 MILNER AVE., SCARBOROUGH, ONTARIO M1S 3R1, CANADA
YAMAHA ELECTRONIK EUROPA G.m.b.H. SIEMENSSTR. 22-34, 25462 RELINGEN BEI HAMBURG, F.R. OF GERMANY
YAMAHA ELECTRONIQUE FRANCE S.A. RUE AMBROISE CROIZAT BP70 CROISSY-BEAUBOURG 77312 MARNE-LA-VALLEE CEDEX02, FRANCE
YAMAHA ELECTRONICS (UK) LTD. YAMAHA HOUSE, 200 RICKMANSWORTH ROAD WATFORD, HERTS WD1 7JS, ENGLAND
YAMAHA SCANDINAVIA A.B. J A WETTERGRENS GATA 1, BOX 30053, 400 43 VÄSTRA FRÖLUNDA, SWEDEN
YAMAHA MUSIC AUSTRALIA PTY, LTD. 17-33 MARKET ST., SOUTH MELBOURNE, 3205 VIC., AUSTRALIA