

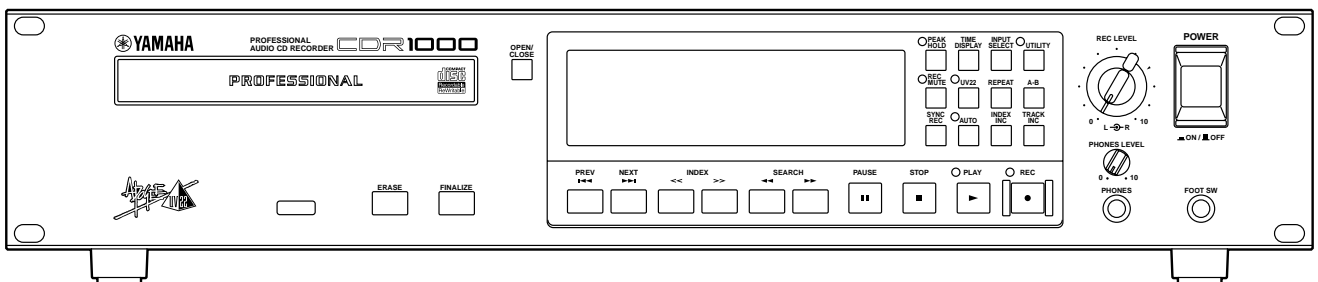

# PROFESSIONAL AUDIO CD RECORDER

# CDR1000

## Owner's Manual

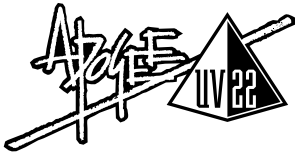

Keep This Manual For Future Reference.



## FCC INFORMATION (U.S.A.)

1. **IMPORTANT NOTICE: DO NOT MODIFY THIS UNIT!** This product, when installed as indicated in the instructions contained in this manual, meets FCC requirements. Modifications not expressly approved by Yamaha may void your authority, granted by the FCC, to use the product.
2. **IMPORTANT:** When connecting this product to accessories and/or another product use only high quality shielded cables. Cable/s supplied with this product **MUST** be used. Follow all installation instructions. Failure to follow instructions could void your FCC authorization to use this product in the USA.
3. **NOTE:** This product has been tested and found to comply with the requirements listed in FCC Regulations, Part 15 for Class "B" digital devices. Compliance with these requirements provides a reasonable level of assurance that your use of this product in a residential environment will not result in harmful interference with other electronic devices. This equipment generates/uses radio frequencies and, if not installed and used according to the instructions found in the users manual, may cause interference harmful to the operation of other electronic devices. Compliance with FCC regulations does not guarantee that interference will not occur in all installations. If this product is found to be the source of interference, which can be determined by turning the unit "OFF" and "ON", please try to eliminate the problem by using one of the following measures: Relocate either this product or the device that is being affected by the interference. Utilize power outlets that are on different branch (circuit breaker or fuse) circuits or install AC line filter/s. In the case of radio or TV interference, relocate/reorient the antenna. If the antenna lead-in is 300 ohm ribbon lead, change the lead-in to coaxial type cable. If these corrective measures do not produce satisfactory results, please contact the local retailer authorized to distribute this type of product. If you can not locate the appropriate retailer, please contact Yamaha Corporation of America, Electronic Service Division, 6600 Orangethorpe Ave, Buena Park, CA 90620

The above statements apply **ONLY** to those products distributed by Yamaha Corporation of America or its subsidiaries.

### WARNING: THIS APPARATUS MUST BE EARTHED **IMPORTANT**

THE WIRES IN THIS MAINS LEAD ARE COLOURED IN ACCORDANCE WITH THE FOLLOWING CODE:

GREEN-AND-YELLOW : EARTH  
BLUE : NEUTRAL  
BROWN : LIVE

As the colours of the wires in the mains lead of this apparatus may not correspond with the coloured markings identifying the terminals in your plug, proceed as follows:

The wire which is coloured GREEN and YELLOW must be connected to the terminal in the plug which is marked by the letter E or by the safety earth symbol  $\perp$  or coloured GREEN and YELLOW.

The wire which is coloured BLUE must be connected to the terminal which is marked with the letter N or coloured BLACK.

The wire which is coloured BROWN must be connected to the terminal which is marked with the letter L or coloured RED.

\* This applies only to products distributed by YAMAHA KEMBLE MUSIC (U.K.) LTD.

### Laser Diode Properties

- \* Material : GaAlAs
  - \* Wavelength : 780-790 nm
  - \* Emission Duration : Continuous
  - \* Laser Output Power : Less than 44.6  $\mu$ W
- (Note) Laser output is measured at a distance of 20cm from the object lens on the optical pick-up head.

CLASS 1 LASER PRODUCT  
LUOKAN 1 LASERLAITE  
KLASS 1 LASERAPPARAT

This unit is classified as a Class 1 laser product. This label is located on the exterior.

Klassmärkning för Finland.

CAUTION : INVISIBLE LASER RADIATION WHEN OPEN. AVOID EXPOSURE TO BEAM.  
WARNING : OSYNLIG LASERSTRÅLNING NÄR DENNA DEL ÄR ÖPPEND. STRÅLEN ÄR FARLIG.  
VARO! : NÄKYMÄTÖNTÄ AVATTAESSA OLET ALLTIINA LASERÄTEILYLLE. ÄLÄ KATSO SÄTEESEEN.  
WARNING : OSYNLIG LASERSTRÅLNING NÄR DENNA DEL ÄR ÖPPNAD. BETRÄKTA EJ STRÅLEN.  
VORSICHT! : UNSICHTBARE LASERSTRAHLUNG WENN ABDECKUNG GEÖFFNET. NICHT DEM STRAHL AUSSETZEN.

- On USA or Canadian models do not have this label.
- This label is located on the interior.
- Varningsanvisning för laserstrålning. Placerad i apparaten.

## JUISTE GEBRUIK EN BEHANDELING VAN BATTERIJEN

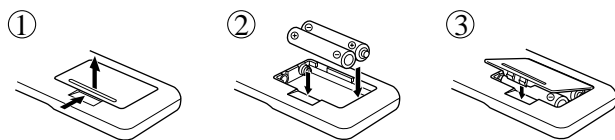

LET BIJ HET VERWISSELEN VAN ZWAKKE OF LEGE BATTERIJEN OP HET JUISTE VOLTAGE EN DE JUISTE POLARITEIT ZOALS VEREIST VOOR DE AKTIEVE ELEKTRONICA.

Bij dit product zijn batterijen geleverd. Wanneer deze leeg zijn, moet u ze niet weggooien maar inleveren als KCA



### CAUTION

USE OF CONTROLS OR ADJUSTMENTS OR PERFORMANCE OF PROCEDURES OTHER THAN THOSE SPECIFIED HEREIN MAY RESULT IN HAZARDOUS RADIATION EXPOSURE.

### ADVASEL

Usynlig laserstrålning ved åbning. Undgå udsættelse for strålning.

### VAROITUS

Laitteen käyttäminen muulla kuin tässä käyttöohjeessa mainitulla tavalla saattaa altistaa käyttäjän turvallisuusluokan 1 ylittävälle näkymättömälle lasersäteilylle.

### WARNING

Om apparaten används på annat sätt än i denna bruksanvisning specificerats, kan användaren utsättas för osynlig laserstrålning, som överskrider gränsen för laserklass 1.

---

# Important Information

---

## Read the Following Before Operating the CDR1000

### Warnings

- Do not subject the CDR1000 to extreme temperatures, humidity, direct sunlight, or dust, which could be a potential fire or electrical shock hazard.
- Do not allow water to enter this unit or allow the unit to become wet. Fire or electrical shock may result.
- Connect the power cord only to an AC outlet of the type stated in this *Owner's Manual* or as marked on the CDR1000. Failure to do so is a fire and electrical shock hazard.
- Hold the power cord plug when disconnecting from an AC outlet. Never pull the cord. A power cord damaged through pulling is a potential fire and electrical shock hazard.
- Do not touch the power plug with wet hands. Doing so is a potential electrical shock hazard.
- Do not place heavy objects, including the CDR1000, on top of the power cord. A damaged power cord is a fire and electrical shock hazard. In particular, be careful not to place heavy objects on a power cord covered by a carpet.
- Do not scratch, bend, twist, pull, or heat the power cord. A damaged power cord is a fire and electrical shock hazard.
- If the power cord is damaged (e.g., cut or a bare wire is exposed), ask your dealer for a replacement. Using the CDR1000 with a damaged power cord is a fire and electrical shock hazard.
- Do not plug several devices into the same AC outlet. This may overload the AC outlet, and could be a fire or electrical shock hazard. It may also affect the performance of some equipment.
- If you notice any abnormality, such as smoke, odor, or noise, or if a foreign object or liquid gets inside the CDR1000, turn it off immediately. Remove the power cord from the AC outlet and consult your dealer for repair. Using the CDR1000 in this condition is a fire and electrical shock hazard.
- Do not place small objects on top of the CDR1000. Metal objects falling inside the CDR1000 is a fire and electrical shock hazard.
- If a foreign object or water gets inside the CDR1000, turn it off immediately. Remove the power cord from the AC outlet and consult your dealer for repair. Using the CDR1000 in this condition is a potential fire and electrical shock hazard.
- Should the CDR1000 be dropped or the cabinet be damaged, turn off the power, remove the power plug from the AC outlet, and contact your dealer. If you continue using the unit without heeding this instruction, fire or electrical shock may result.
- Do not remove the CDR1000's cover. You could receive an electrical shock. If you think internal inspection, maintenance, or repair is necessary, contact your dealer.
- Do not attempt to modify the CDR1000. This is a potential fire and electrical shock hazard.

- Do not block the CDR1000 ventilation slots. The CDR1000 has ventilation slots at the side and a cooling fan at the rear to keep the internal components cool. Blocking the ventilation slots or obstructing the fan's airflow is a potential fire hazard.

## Cautions

- Allow enough free space around the unit for normal ventilation. This should be: 10 cm at the sides, 40 cm behind, and 30 cm above. These distances should also be adopted when rack-mounting the CDR1000. For normal ventilation during use, remove the rear of the rack or open a ventilation hole. If the airflow is not adequate, the CDR1000 will heat up inside and may cause a fire.
- Do not look at the laser beam. You may damage your vision.
- Use the CDR1000 in an environment where the temperature is between 5°C and 35°C (41°F and 95°F).
- Turn off audio devices when connecting them to the CDR1000, and use only the cables specified in the relevant owner's manuals.
- If you plan not to use the CDR1000 for a long period of time, remove the power cord from the AC outlet. Leaving the CDR1000 connected is a potential fire hazard.
- Do not use benzene, thinner, cleaning detergent, or a chemical cloth to clean the CDR1000. Use only a soft, dry cloth.
- Do not attempt to move the CDR1000 during recording. Doing so may interrupt the recording process and render the disc unusable.
- If the CDR1000 is stored in a cold place (e.g., overnight in a car), and then moved to a warmer environment, or the temperature rises sharply, condensation may form inside the CDR1000, which may affect performance. In such cases, the CDR1000 should be allowed to acclimatize for about one hour before use.

## Handling Discs

- Use only discs of the type specified in this *Owner's Manual*.
- Store discs in a place free from extreme temperatures, humidity, dust, and dirt.
- Always store discs in their cases.
- When handling discs, be careful not to touch the surface. Hold discs by the edge. Fingerprints, smudges, scratches, or dirt can affect recording and playback.
- Be careful not to scratch the labeled side of the disc. Even scratches on this side of the disc can affect recording and playback.
- Fingerprints and dust should be removed by wiping gently from the center of the disc towards the disc edge, using a soft, dry cloth. Never wipe in a circular motion and never rub a disc hard with a dry cloth.
- For stubborn stains and dirt, use a cleaning kit designed specifically for use with CDs. Do not use benzene, thinner, cleaning detergent, or a chemical cloth.
- For disc marking, use only pens specifically designed for writing on CDs and write only on the specified area. Do not attach a label to a disc.
- If a disc is stored in a cold place (e.g., overnight in a car), and then moved to a warmer environment, or the temperature rises sharply, condensation may form on the disc surface, which may affect performance. In such cases, the disc should be allowed to acclimatize for about one hour before use.
- Do not under any circumstances attempt to use discs that are cracked or warped. Doing so may seriously damage the CDR1000.

---

## Interference

The CDR1000 uses high-frequency digital circuits that may cause interference on radio and television equipment located nearby. If interference is a problem, relocate the affected equipment.

## CDR1000 Exclusion of Certain Responsibility

Manufacturer, importer, or dealer shall not be liable for any incidental damages including personal injury or any other damage caused by improper use or operation of the CDR1000.

Yamaha cannot be held responsible for any loss of data or data damage due to improper use or operation of the CDR1000. Furthermore, Yamaha cannot be held responsible for unusable media.

## Package Contents

The CDR1000 package should contain the following items. Contact your Yamaha dealer if anything is missing.

- CDR1000 Professional Audio CD Recorder
- Power cord
- Remote controller
- Batteries for the remote controller (size AA, R6, UM-3)
- Spare transportation pad
- This manual

## Trademarks

UV22 is a trademark and Apogee is a registered trademark of Apogee Electronics Corporation. Yamaha is a trademark of Yamaha Corporation. All other trademarks are the property of their respective holders and are hereby acknowledged.

## Copyright

No part of the CDR1000 software or this *Owner's Manual* may be reproduced or distributed in any form or by any means without the prior written authorization of Yamaha Corporation.

© 1999 Yamaha Corporation. All rights reserved.

### Note

**This equipment has been produced for professional use. Use of this equipment to record and use musical works requires the permission of all relevant copyright holders. Yamaha does not accept any responsibility for any trouble that might arise with copyright holders due to the use of musical works on this equipment without permission of the copyright holders.**

# Contents

---

<b>1 Introduction . . . . .</b>	<b>1</b>	Incrementing Track Numbers Manually . . . . .	32
Welcome . . . . .	1	Incrementing Index Numbers Manually . . . . .	33
About this Manual . . . . .	1	Using Auto Rec Start & Track Increment . . . . .	34
Installation . . . . .	1	Inserting a Two-second Mute . . . . .	35
CDR1000 Features . . . . .	2	Applying a Fade In . . . . .	37
Operating Notes . . . . .	4	Applying a Fade Out . . . . .	38
<b>2 Touring the CDR1000 . . . . .</b>	<b>6</b>	Sync Recording from CD, MD, or DAT . . . . .	39
Front Panel . . . . .	6	Finalizing Discs . . . . .	44
Display . . . . .	8	Erasing Discs (CD-RW only) . . . . .	45
Function Buttons . . . . .	9	<b>6 Other Functions . . . . .</b>	<b>46</b>
Rear Panel . . . . .	11	Selecting the AES/EBU OUT Playback Clock . . . . .	46
Remote Controller . . . . .	13	Using Digital Output Thru . . . . .	48
Block Diagram . . . . .	14	Using a Footswitch . . . . .	50
<b>3 The Basics . . . . .</b>	<b>15</b>	Disabling the Remote Controller . . . . .	50
Hookup Examples . . . . .	15	Using the Parallel Port . . . . .	51
Connecting the Power Cord . . . . .	16	<b>Troubleshooting . . . . .</b>	<b>52</b>
Turning On the Power . . . . .	16	<b>Appendix . . . . .</b>	<b>54</b>
Using the Transportation Pad . . . . .	17	Error Messages . . . . .	54
Loading & Unloading Discs . . . . .	18	Specifications . . . . .	55
Using the Remote Controller . . . . .	19	Dimensions . . . . .	57
Setting the Time Display . . . . .	19	<b>Glossary . . . . .</b>	<b>58</b>
Monitoring . . . . .	20	<b>Index . . . . .</b>	<b>59</b>
Metering & Peak Hold . . . . .	20		
Setting the Meter Response Rate . . . . .	20		
<b>4 Playback . . . . .</b>	<b>21</b>		
Playing Discs . . . . .	21		
Pausing Playback . . . . .	21		
Stopping Playback . . . . .	21		
Playback Operation Table . . . . .	22		
Selecting Tracks . . . . .	23		
Selecting Tracks Directly . . . . .	23		
Selecting Indexes . . . . .	23		
Searching . . . . .	24		
Using Repeat Playback . . . . .	24		
<b>5 Recording . . . . .</b>	<b>25</b>		
Preparing to Record . . . . .	25		
Selecting the Input Source . . . . .	25		
Setting the Sampling Rate Converter . . . . .	26		
Setting the Input Delay . . . . .	27		
Setting the UV22 . . . . .	28		
Setting the Copy Bit . . . . .	28		
Recording . . . . .	29		
Recording Operation Table . . . . .	31		

---

# 1 Introduction

---

## Welcome

Thank you for choosing the Yamaha CDR1000 Professional Audio CD Recorder.

The CDR1000 is a stand-alone professional audio CD recorder that can record onto blank and partially recorded CD-R and CD-RW discs, and playback prerecorded audio CDs and unfinalized or finalized CD-R or CD-RW discs.

See page 2 for a concise rundown of CDR1000 features.

## About this Manual

This *Owner's Manual* contains all the information you need in order to operate your CDR1000 Professional Audio CD Recorder. Use the table of contents to familiarize yourself with the organization of this manual and locate topics, and use the index to locate specific information. A glossary of CDR1000-related jargon is provided on page 58.

## Installation

The CDR1000 can be used freestanding on a stable surface, somewhere that complies with the important information at the beginning of this manual, or mounted in a rack.

When mounting the CDR1000 in a rack, leave adequate ventilation space around the CDR1000 (at least 10 cm of free space behind). If the CDR1000 is mounted in a portable rack case, keep the rear of the case open when using the CDR1000, so as not to obstruct the flow of air from the cooling fan. Do not mount the CDR1000 next to equipment that produces a lot of heat, such as a power amplifier.

### Transportation Pad

When transporting the CDR1000, always use the transportation pad shown below.

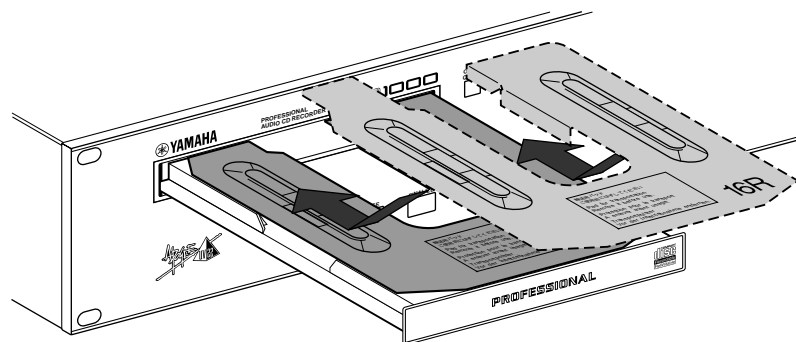

See “Installing the Transportation Pad” on page 17 for more information.

## CDR1000 Features

### Recording Media

- CD-R (Compact Disc Recordable)
- CD-RW (Compact Disc Rewritable)

### Sonic Performance

- 20-bit 64-times oversampling A/D converters
- 20-bit 128-times oversampling D/A converters
- UV22 Super CD Encoding

### Flexible I/O

- AES/EBU and coaxial (S/PDIF) digital I/O
- Balanced XLR analog I/O (switchable  $-10$  dBV/ $+4$  dB)
- Headphone output

### Recording

- Up to 99 tracks per disc, up to 99 indexes per track
- Built-in sampling-rate converter for recording 30/50 kHz sources
- Input delay (up to 4.95 seconds) buffers incoming audio, ensuring the start of a performance is not missed
- Fade in and fade out (1 to 10 seconds)
- Two-second mute insertion
- Auto record start and track increment
- Manual track increment recording function
- Manual index increment recording function
- Synchronized recording from CD, MD, or DAT (Track, Index, Start ID, Skip ID)
- CD-RW: Last Track Erase, Disk Erase, and Initialize Erase
- Autofinalize/unfinalize

### Playback

- CD-DA player
- Play unfinalized or finalized CD-R or CD-RW discs
- One Track Repeat, All Track Repeat, and A-B Repeat modes
- AES/EBU OUT lock to external wordclock source



## Quick Locate

- Previous and next track locate
- Previous and next index locate
- Forward and reverse search
- Direct track selection from the remote controller

## Display

- Large, easy-to-read vacuum fluorescent display
- Dedicated track and index counters
- Elapse, Remain, and Total time display modes
- 16-segment level meters, with peak hold

## Remote Control

- Wireless remote controller
- 9-pin parallel interface
- Optional footswitch

## Others

- Copy Bit setting
- Digital output thru setting for daisy-chain connection of multiple CDR1000s
- 2U rack mount chassis

## Operating Notes

This section contains information that will help you get the most from your CDR1000.

### Playback

The CDR1000 can play prerecorded audio CDs and unfinalized or finalized CD-R or CD-RW discs. Only Session 1 of a multi-session disc can be played.

### Recording

The CDR1000 can record onto CD-R and CD-RW discs that feature one of the following logos.

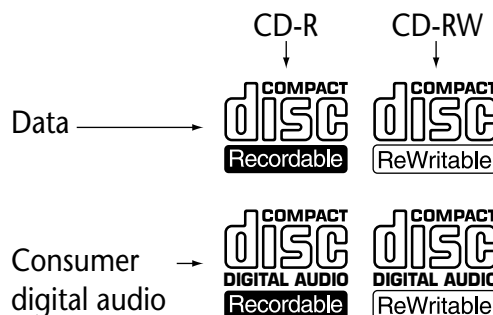

The CDR1000 can record up to 99 tracks per disc and up to 99 indexes per track, the standard for audio CDs. The minimum length of a track is four seconds, so even if you stop recording before four seconds is up, the final track will be four seconds long.

### OPC

Each time an unfinalized CD-R or CD-RW disc is loaded, the CDR1000 performs an OPC (Optimum Power Control) test to determine the optimum laser power necessary for recording. During OPC testing, “OPC” appears on the display and no other functions can be used until testing is complete.

For unfinalized CD-R discs, if OPC has been performed 94 times, finalization is performed automatically. If an unfinalized CD-R disc on which OPC has been performed more than 95 times is loaded, “OPC OVER” appears on the display, which means that the disc cannot be used for recording. For this reason, we recommend that you do not load unfinalized CD-R discs into the CDR1000 unnecessarily.

### TOC & PMA

CDs store track and index numbers, track start and end times, and track length information in a TOC (Table of Contents), which is read each time a disc is loaded into a CD player. Since the final TOC cannot be written to disc until all tracks have been recorded, a temporary table of contents is written to the PMA (Program Memory Area), an area of the disc reserved specifically for this purpose. While the temporary table of contents is being written, “WAIT” appears on the display and no other functions can be used. When a partially recorded disc is loaded, the CDR1000 reads the temporary table of contents to see what’s already been recorded and determine the time available for additional recording.

## Finalization

The finalization process writes the final TOC to disc, so that discs can be played on standard CD players.

Unfinalized CD-R discs can be played on other CD-R recorders, but cannot be played on standard CD players until they have been finalized. Once finalized, CD-R discs cannot be used for additional recording and are fixed for life.

Unfinalized CD-RW discs can be played on other CD-RW recorders. Unlike CD-R discs, CD-RW discs can be erased, and you can erase the last track or the entire disc.

## Emphasis & the CDR1000

When a digital audio signal containing emphasis information (15  $\mu$ s/50  $\mu$ s) is received, the CDR1000 automatically detects, and records it.

## 2 Touring the CDR1000

### Front Panel

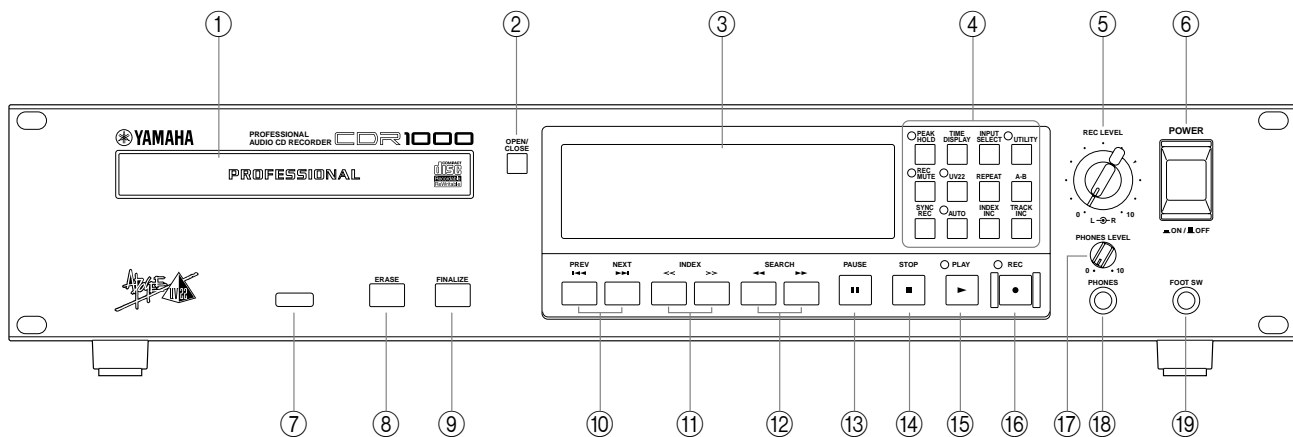

- ① **Disc tray**  
Discs are loaded into the CDR1000 using the disc tray. See “Loading & Unloading Discs” on page 18 for more information.
- ② **OPEN/CLOSE button**  
This button is used to open and close the disc tray.
- ③ **Display**  
See “Display” on page 8 for more information.
- ④ **Functions buttons**  
See “Function Buttons” on page 9 for more information.
- ⑤ **REC LEVEL control**  
This control is used to set the recording level for analog input sources. The left and right channels can be set independently. See “Recording” on page 29 for more information.
- ⑥ **POWER switch**  
This switch is used to turn on the power to the CDR1000. It’s recessed to prevent accidental operation. See “Turning On the Power” on page 16 for more information.
- ⑦ **Remote controller sensor**  
Infrared signals transmitted by the remote controller are received here.
- ⑧ **ERASE button**  
This button selects the Erase function. See “Erasing Discs (CD-RW only)” on page 45 for more information.
- ⑨ **FINALIZE button**  
This button selects the Finalize function. See “Finalizing Discs” on page 44 for more information.

⑩ **PREV & NEXT buttons**

These buttons are used to select tracks. Pressing the PREV [◀◀] button during playback selects the top of the current track. Pressing it again selects the top of the previous track. Pressing the NEXT [▶▶] button during playback selects the top of the next track. See “Selecting Tracks” on page 23 for more information. These buttons are also used with the Utility, Erase, and Sync Recording functions.

⑪ **INDEX buttons**

These buttons are used to select indexes. Pressing the previous INDEX [◀◀] button during playback selects the top of the current index. Pressing it again selects the top of the previous index. Pressing the next INDEX [▶▶] button during playback selects the top of the next index. See “Selecting Indexes” on page 23 for more information.

⑫ **SEARCH buttons**

These buttons are used to search backwards and forwards at high speed during playback or playback pause. Pressing and holding the backward SEARCH [◀◀] button searches backwards. Pressing and holding the forward SEARCH [▶▶] button searches forwards. See “Searching” on page 24 for more information.

⑬ **PAUSE button**

This button is used to pause and resume playback and recording. When recording is paused, the CDR1000 waits in Record Standby mode. The PAUSE indicator appears on the display when playback is paused or in Record Standby mode.

⑭ **STOP button**

This button is used to stop playback and recording.

⑮ **PLAY button & indicator**

This button is used to start playback and recording. The PLAY indicator lights up during playback and recording. See “Playing Discs” on page 21 for more information.

⑯ **REC button & indicator**

This button is used to engage Record Standby mode. The REC indicator flashes in Record Standby mode and lights up continuously while recording. See “Recording” on page 29 for more information.

⑰ **PHONES LEVEL control**

This control is used to adjust the volume level of the phones. See “Monitoring” on page 20 for more information.

⑱ **PHONES jack**

A pair of stereo headphones can be connected to this stereo phone jack for monitoring. See “Monitoring” on page 20 for more information.

The following illustration shows the wiring scheme for the headphones.

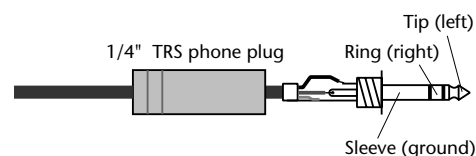

⑲ **FOOT SW jack**

An optional footswitch can be connected to this jack and used to start and stop recording or playback. See “Using a Footswitch” on page 50 for more information.

## Display

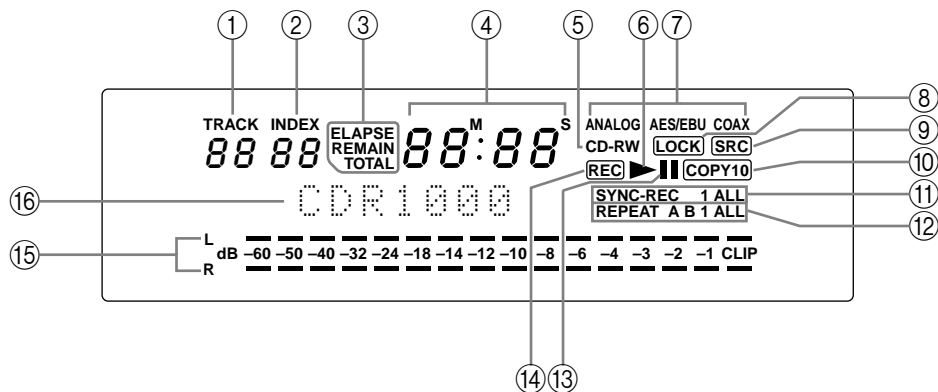

- ① **TRACK counter**  
The track counter displays the selected track number.
- ② **INDEX counter**  
The index counter displays the selected index number.
- ③ **ELAPSE, REMAIN & TOTAL indicators**  
These indicators show the selected time display mode. See “Setting the Time Display” on page 19 for more information.
- ④ **Time counter**  
These four digits display the playback and recording time in minutes and seconds.
- ⑤ **Disk type indicator**  
These indicators show the type and status of the loaded disc. See “Disc Type & Status” on page 18 for more information.
- ⑥ **PLAY (▶) indicator**  
This indicator lights up during playback and recording, and flashes during finalization, erasure, and PMA writing.
- ⑦ **ANALOG, AES/EBU & COAX indicators**  
These indicators show the selected input source. See “Selecting the Input Source” on page 25 for more information.
- ⑧ **LOCK indicator**  
This indicator shows whether or not the CDR1000 is locked to the selected digital input source. See “Selecting the Input Source” on page 25 for more information.
- ⑨ **SRC indicator**  
The SRC (sampling rate converter) indicator lights up when the CDR1000’s built-in sampling rate converter is active during recording. See “Setting the Sampling Rate Converter” on page 26 for more information.
- ⑩ **COPY indicators**  
These indicators show the Copy Bit setting. See “Setting the Copy Bit” on page 28 for more information.

- ⑪ **SYNC-REC indicators**  
These indicators are used with the Sync Recording functions. See “Sync Recording from CD, MD, or DAT” on page 39 for more information.
- ⑫ **REPEAT indicators**  
These indicators are used with the Repeat Playback functions. See “Using Repeat Playback” on page 24 for more information.
- ⑬ **PAUSE (||) indicator**  
This indicator lights up when playback is paused or in Record Standby mode.
- ⑭ **REC indicator**  
This indicator flashes in Record Standby mode and lights up continuously while recording.
- ⑮ **L & R level meters**  
These 16-segment meters, with peak hold, display playback and recording levels from –60 dB through to –1 dB, and CLIP. See “Metering & Peak Hold” on page 20 for more information.
- ⑯ **Message area**  
This 12-character message area displays the status and operating mode of the CDR1000 and Utility function parameters.

## Function Buttons

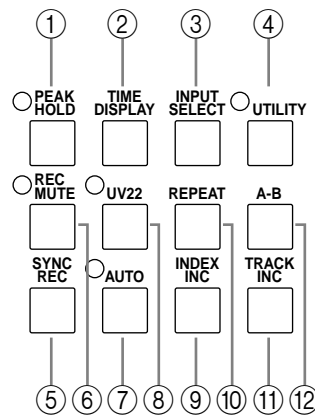

- ① **PEAK HOLD button & indicator**  
This button is used to turn on and off the Peak Hold function. The PEAK HOLD indicator lights up when the Peak Hold function is on. See “Metering & Peak Hold” on page 20 for more information.
- ② **TIME DISPLAY button**  
This button is used to select the time display mode: ELAPSE, REMAIN, or TOTAL. The selected mode is indicated on the display. See “Setting the Time Display” on page 19 for more information.
- ③ **INPUT SELECT button**  
This button is used to select the input source: ANALOG, AES/EBU, or COAXIAL. The selected input source is indicated on the display. See “Selecting the Input Source” on page 25 for more information.

④ **UTILITY button & indicator**

This button is used to select the Utility functions. The UTILITY indicator lights up when a Utility function is selected.

Utility Function	Settings
AUTO TRACK INC dB	30, 35, 40, 45, 50, 55, 60, 70, 96 -dB
AUDIO DELAY	0, 66, 132, 198, 264, 330, 396, 462...4,950 ms
FADE IN	0, 1, 2, 3, 4, 5, 6, 7, 8, 9, 10 second
FADE OUT	0, 1, 2, 3, 4, 5, 6, 7, 8, 9, 10 second
FALL TIME	SLOW, FAST
CLOCK SELECT	INT, WORD, AES, COAX
DIGITAL OUT	NORMAL, THRU
COPY BIT	PERMIT, ONCE, PROTECT
REMOTE	ON, OFF
SRC	ON, AUTO

⑤ **SYNC REC button**

This button is used to select Sync Recording and Auto Finalize. See “Sync Recording from CD, MD, or DAT” on page 39 for more information.

⑥ **REC MUTE button & indicator**

This button is used to insert a two-second mute between songs. The REC MUTE indicator flashes in Rec Mute Standby mode. See “Inserting a Two-second Mute” on page 35 for more information.

⑦ **AUTO button & indicator**

This button is used to turn on and off the Auto Rec/Track function. The AUTO indicator lights up when the Auto Rec/Track function is on. See “Using Auto Rec Start & Track Increment” on page 34 for more information.

⑧ **UV22 button & indicator**

This button is used to turn on and off the UV22 function. The UV22 indicator lights up when the UV22 function is on. See “Setting the UV22” on page 28 for more information.

⑨ **INDEX INC button**

This button is used to manually increment the index number during recording. See “Incrementing Index Numbers Manually” on page 33 for more information.

⑩ **REPEAT button**

This button is used to select the Repeat Playback functions. See “Using Repeat Playback” on page 24 for more information.

⑪ **TRACK INC button**

This button is used to manually increment the track number during recording. See “Incrementing Track Numbers Manually” on page 32 for more information.

⑫ **A-B button**

This button is used to set the A and B points for A-B Repeat Playback. The A and B indicators light up when the respective A or B point is set. See “Using Repeat Playback” on page 24 for more information.



## Rear Panel

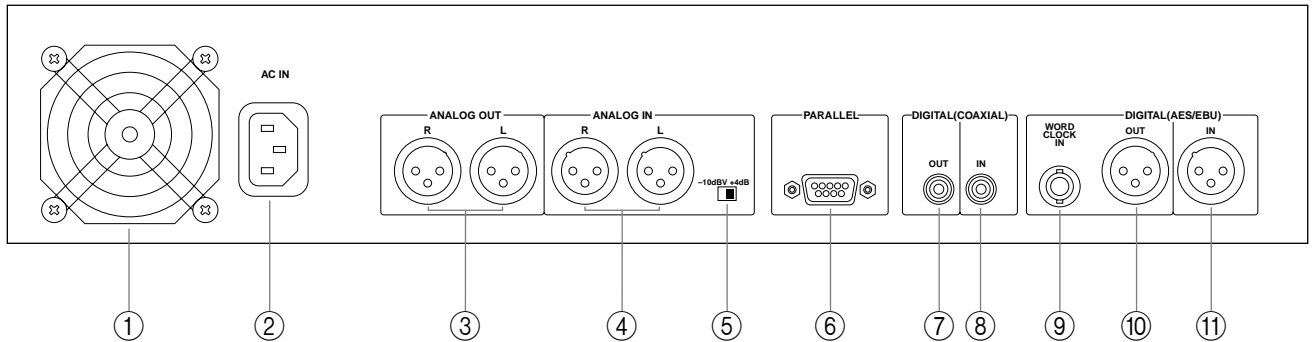

### ① Cooling fan

The cooling fan keeps the internal components cool. See “Installation” on page 1 for more information.

### ② AC IN connector

This connector is used to connect the CDR1000 to an AC outlet, using the supplied power cord. See “Connecting the Power Cord” on page 16 for more information.

### ③ ANALOG OUT connectors

These balanced male XLR-3-32 type connectors output analog playback and monitor signals. They are wired pin 1–ground, pin 2–hot (+), and pin 3–cold (–).

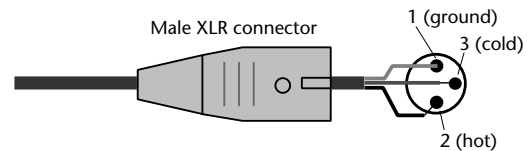

### ④ ANALOG IN connectors

These balanced female XLR-3-31 type connectors are used to connect analog input signals. They are wired pin 1–ground, pin 2–hot (+), and pin 3–cold (–). See “Selecting the Input Source” on page 25 for more information.

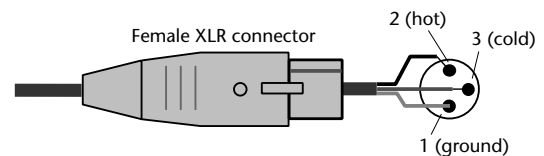

If you need to connect the balanced ANALOG IN or ANALOG OUT to unbalanced equipment, using phone or phono connectors, link XLR pins 1 and 3, as shown in the following illustration for an unbalanced phone-plug to female XLR cable.

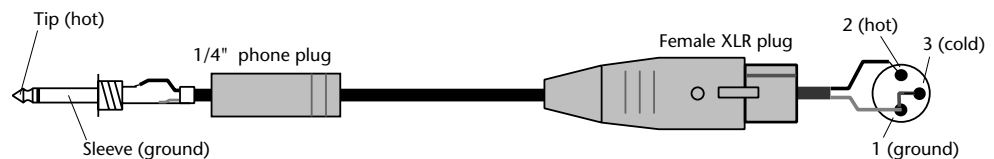

### ⑤ ANALOG IN level switch

This switch is used to set the input sensitivity of the ANALOG IN connectors to either +4 dB or –10 dBV.

- ⑥ **PARALLEL port**  
This 9-pin D-sub connector is a general purpose interface that provides access to various CDR1000 functions. By using custom made switches and cables, it can be used for simultaneous control of multiple CDR1000s in multiple disc recording, or disc duplication systems. See “Using the Parallel Port” on page 51 for more information.
- ⑦ **DIGITAL COAXIAL OUT connector**  
This phono jack outputs playback and monitor signals as S/PDIF format digital audio.
- ⑧ **DIGITAL COAXIAL IN connector**  
This phono jack is used to connect S/PDIF format digital audio sources. See “Selecting the Input Source” on page 25 for more information.
- ⑨ **WORD CLOCK IN connector**  
This BNC connector is used to connect an external wordclock source, which can be used to lock the AES/EBU OUT during playback. See “Selecting the AES/EBU OUT Playback Clock” on page 46 for more information.
- ⑩ **DIGITAL AES/EBU OUT connector**  
This male XLR-3-32 type connector outputs playback and monitor signals as AES/EBU format digital audio.
- ⑪ **DIGITAL AES/EBU IN connector**  
This female XLR-3-31 type connector is used to connect AES/EBU format digital audio sources. See “Selecting the Input Source” on page 25 for more information.

## Remote Controller

Apart from the number keypad, which is unique to the remote controller, remote controller buttons operate the same as their counterparts on the CDR1000 front panel.

- ① **OPEN/CLOSE button**
- ② **REC MUTE button**
- ③ **INPUT SELECT button**
- ④ **AUTO button**
- ⑤ **Number keypad**  
The number keypad is used to select tracks for playback. See page 23 for more information.
- ⑥ **PREV & NEXT buttons**
- ⑦ **SEARCH buttons**
- ⑧ **PAUSE button**
- ⑨ **STOP button**
- ⑩ **PEAK HOLD button**
- ⑪ **TIME DISPLAY button**
- ⑫ **REPEAT button**
- ⑬ **A-B button**
- ⑭ **TRACK INC button**
- ⑮ **INDEX INC button**
- ⑯ **INDEX buttons**
- ⑰ **SYNC REC button**
- ⑱ **REC button**
- ⑲ **PLAY button**

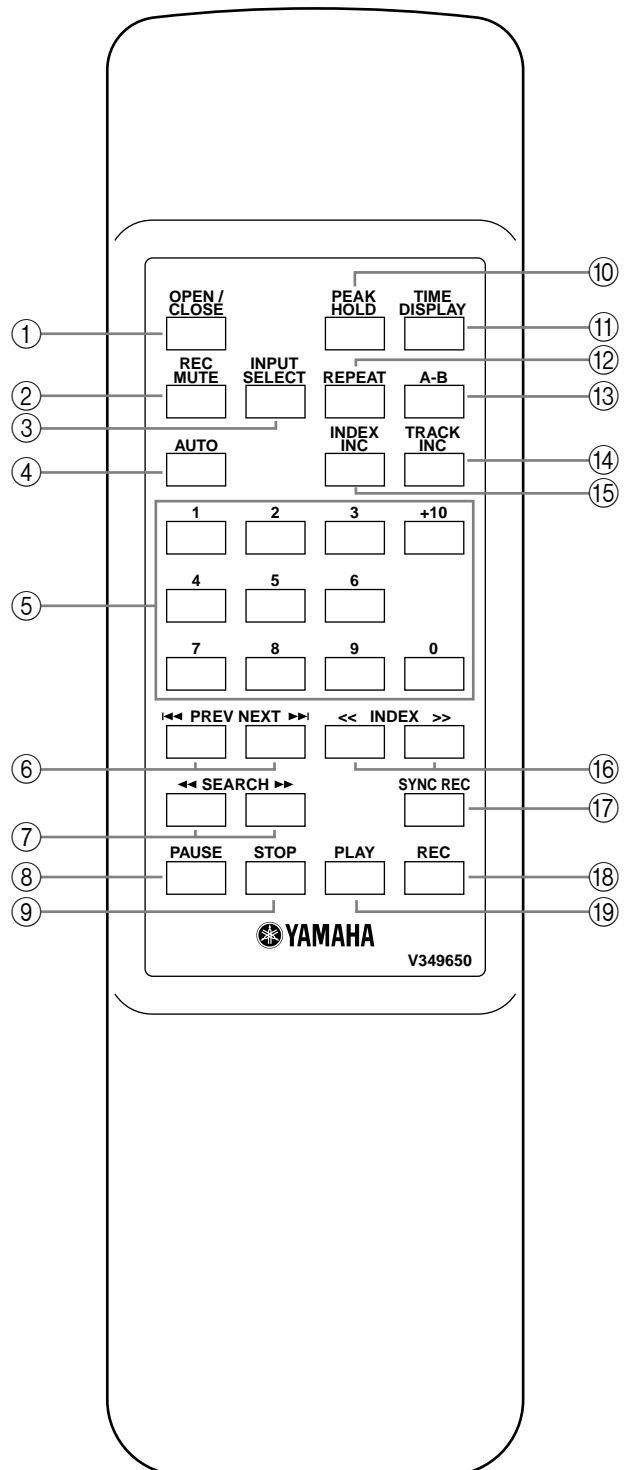

# Block Diagram

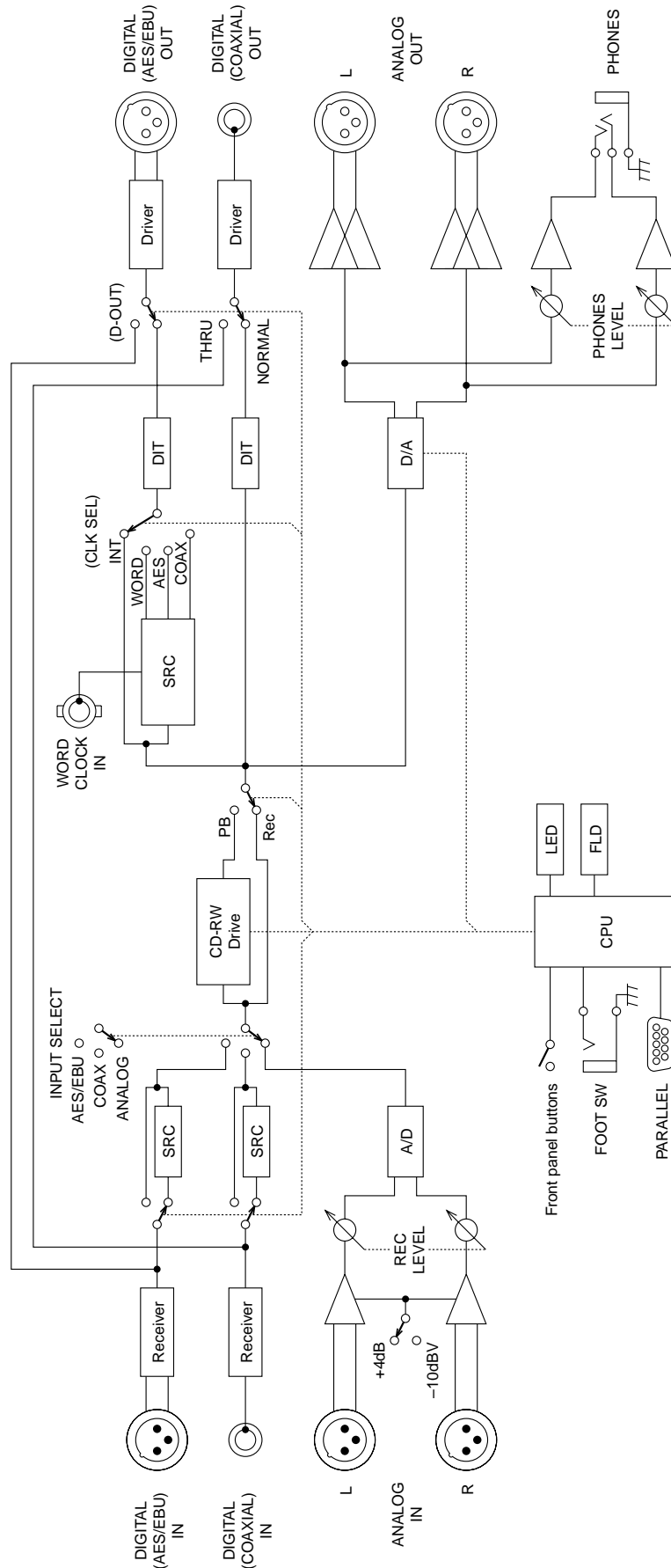

# 3 The Basics

## Hookup Examples

### Analog

Use the balanced XLR analog inputs and outputs to connect analog mixers, recorders, or other equipment with analog inputs and outputs.

Use the level switch to set the input sensitivity of the ANALOG IN connectors to either +4 dB or -10 dBV.

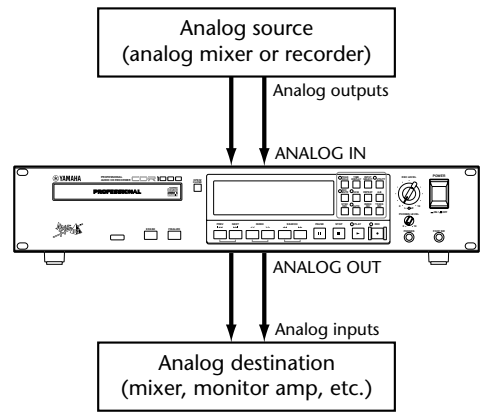

### Coaxial

Use the COAXIAL IN and OUT to connect CD, DAT, MD, or other equipment with S/PDIF format coaxial inputs and outputs.

Use only phono cables with a 75Ω impedance for coaxial connections. Using ordinary audio cables can cause digital audio transmission errors.

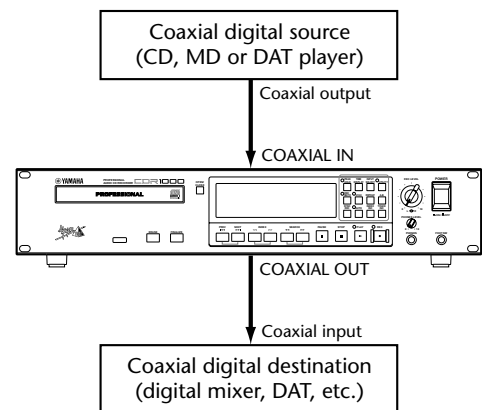

### AES/EBU

Use the AES/EBU IN and OUT to connect to digital mixers, recorders, or other professional equipment with AES/EBU digital inputs and outputs.

Ordinary balanced XLR audio cables can be used for AES/EBU digital connections.

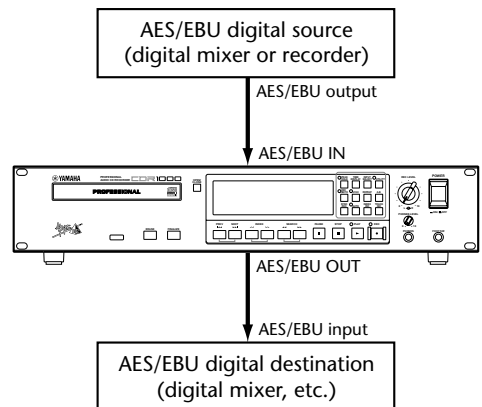

## Connecting the Power Cord

*Warning: Turn off all equipment before making any power connections.*

Connect the socket-end of the supplied power cord to the AC IN socket on the rear panel of the CDR1000, and connect the plug-end to a suitable AC wall outlet, one that conforms to the power supply requirements stated on the CDR1000 rear panel.

AC IN

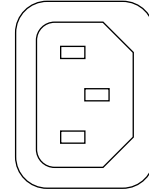

## Turning On the Power

To prevent loud clicks and thumps in your loudspeakers, turn on your audio equipment in the following order (reverse this order when turning off your equipment)—sound sources, CDR1000, mixing console, monitor amplifier.

- 1 Press the [POWER] switch to turn on the CDR1000.

The CDR1000 initializes itself and “SELF-CHECK” appears on the display. The type of disc loaded is then determined and “READING” appears. If no disc is loaded, “NO DISC” appears.

- 2 Press the [POWER] switch again to turn off the CDR1000.

POWER

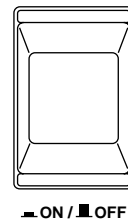

*Note: Always unload discs before turning off the CDR1000.*

## Using the Transportation Pad

The CDR1000 is shipped with a transportation pad in the disc drive to protect the mechanism against damage that may occur during transportation. The pad must be removed before using the CDR1000, as follows: turn on the CDR1000, press the [OPEN/CLOSE] button, and remove the pad from the disc tray.

Keep the transportation pad for future use.

### Installing the Transportation Pad

Before transporting the CDR1000, install the transportation pad, as follows.

- 1 Turn on the CDR1000.
- 2 Press the [OPEN/CLOSE] button to open the disc tray.
- 3 Place the transportation pad on the disc tray, as shown below.

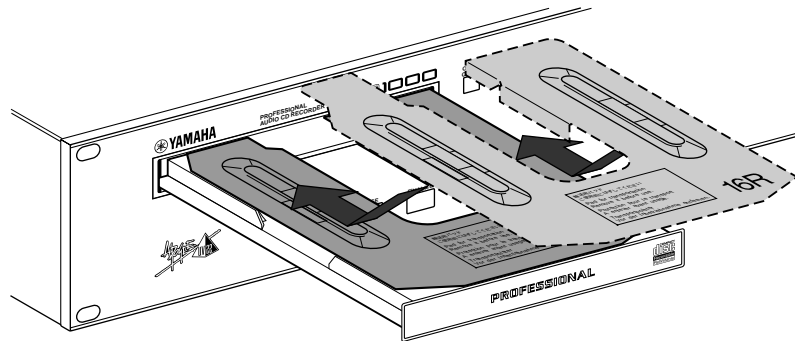

- 4 Press the [OPEN/CLOSE] button to close the disc tray.
  - 5 Once the disc tray has closed, turn off the CDR1000.
- The CDR1000 is now ready to be transported.

## Loading & Unloading Discs

This section explains how to load and unload discs.

- 1 Press the [OPEN/CLOSE] button to open the disc tray.

The disc tray opens and “OPEN” appears on the display.

- 2 Place the disc in the center of the disc tray with the labeled side facing up.
- 3 Press the [OPEN/CLOSE] button again to close the disc tray.

The disc tray closes and “CLOSE” appears on the display.

If the disc tray opens again, make sure the disc is seated correctly in the disc tray.

The disc tray can also be closed by pushing it gently. Do not use excessive force to push the tray when the CDR1000 is turned off, as this may damage the mechanism.

- 4 To unload a disc, stop the current operation, press the [OPEN/CLOSE] button and remove the disc when the disc tray is fully open.

The following table lists the disc-related display messages and their meanings.

Message	Meaning
OPEN	The disc tray is opening.
CLOSE	The disc tray is closing.
READING	The CDR1000 is determining the type of disc and reading its table of contents.
OPC	The CDR1000 is performing OPC (Optimum Power Control). See “OPC” on page 4 for more information.
OPC OVER	The OPC area on the loaded disc is full. Load another disc. See “OPC” on page 4 for more information.
NO DISC	No disc is loaded.
ERROR-xxxxxx	See “Error Messages” on page 54 for more information.
BLANK	An unrecorded disc is loaded.
UNRECORDABLE	The loaded disc cannot be used for recording. Finalize it, or load another disc.
ROM	The loaded disc cannot be played because it contains data, perhaps it’s a CD-ROM. Load another disc.
WAIT	The CDR1000 is writing the PMA. See “TOC & PMA” on page 4 for more information.
OUT OF RANGE	The wordclock input signal is out of the range of the sampling rate converter. See “Setting the Sampling Rate Converter” on page 26.
SELF-CHECK	The CDR1000 is initializing.
CHECK INPUT	The COAXIAL input must be selected to use Sync Recording. See “Selecting the Input Source” on page 25 for more information.
NO CD	The loaded disc is not a CD, CD-R, or CD-RW. Load another disc.

## Disc Type & Status

When a disc is loaded, the CDR1000 determines the type and status of the disc, and then the relevant disc-type indicator lights up, as shown in the following table.

Indicator	Disc type/status
CD	A prerecorded audio CD or finalized CD-R disc
CD-R	Unfinalized CD-R disc
CD-RW	CD-RW disc



## Using the Remote Controller

The CDR1000's wireless, infrared remote controller can be used to control virtually all playback and recording functions remotely. In addition to duplicating most of the buttons found on the CDR1000 front panel, the remote controller features a number keypad for direct track selection. See "Selecting Tracks Directly" on page 23 for more information.

The remote controller does not feature the following front-panel buttons: [UV22], [UTILITY], [ERASE], and [FINALIZE].

### Installing the Remote Controller's Batteries

The remote controller uses two size AA, R6, UM-3 batteries, and two new batteries are supplied with the CDR1000. No special tools are required for installation.

- 1 Remove the battery compartment cover.
- 2 Install the supplied batteries as indicated inside the battery compartment, paying special attention to the polarity (+ to +, – to –).
- 3 Replace the battery compartment cover.

If the remote controller doesn't work, make sure that the batteries are installed correctly. If it still doesn't work, make sure that the Utility Remote parameter is set to ON. See "Disabling the Remote Controller" on page 50 for more information.

If the remote controller fails to work after several months, the batteries may need replacing. Always replace both batteries at the same time, with the specified size.

If the remote controller is not to be used for a long period, for example, more than one month, remove the batteries to prevent damage due to battery leakage.

## Setting the Time Display

The time counter can be set to display the elapsed time, remaining time, or total time for playback and recording by using the Time Display function.

- 1 Use the [TIME DISPLAY] button to select a Time Display mode.

Setting	Description
ELAPSE	Playback or recording time since the beginning of the current track.
REMAIN	Playback or recording time to the end of the disc.
TOTAL	Playback or recording time since the beginning of the disc.

The selected mode is indicated on the display: ELAPSE, REMAIN, or TOTAL.

## Monitoring

Playback signals are output via the ANALOG OUT, AES/EBU OUT, COAXIAL OUT, and PHONES.

For recording, the selected input source can be monitored via the ANALOG OUT, AES/EBU OUT, COAXIAL OUT, and PHONES in Record Standby mode and while recording.

Use the PHONES LEVEL control to adjust the volume level of the phones.

The recording level for the AES/EBU IN or COAXIAL IN is determined by the source and cannot be set on the CDR1000. For playback, the AES/EBU OUT and COAXIAL OUT output digital audio at the same level that it was recorded to disc. For recording, the level is the same as that received at the AES/EBU IN and COAXIAL IN.

The recording level for the ANALOG IN is set using the REC LEVEL control. This affects the level of the ANALOG OUT during recording. After recording, the ANALOG OUT level is fixed, and cannot be adjusted on the CDR1000.

## Metering & Peak Hold

Playback and recording signal levels can be metered on the 16-segment meters, with Peak Hold function, from  $-60$  dB through to  $-1$  dB, and CLIP. For recording, the selected input source can be metered in Record Standby mode and while recording.

Signal peaks can be checked using the Peak Hold function. When Peak Hold is off, meter segments lit by signal peaks remain lit for one second. When Peak Hold is on, however, they remain lit permanently.

- 1 Press the [PEAK HOLD] button to turn on the Peak Hold function.

The PEAK HOLD indicator lights up.

The meter segments lit by the signal peaks remain lit permanently.

- 2 Press the [PEAK HOLD] button again to turn off the Peak Hold function.

The PEAK HOLD indicator goes out.

## Setting the Meter Response Rate

The response rate of the level meters can be set to either Slow or Fast using the Utility Meter parameter.

- 1 Use the [UTILITY] button to select "METER."

The UTILITY indicator lights up and the response rate setting appears on the display.

- 2 Use the [PREV] or [NEXT] button to select a response rate.

Setting	Description
<b>SLOW</b>	Slow response rate.
<b>FAST</b>	Fast response rate.

- 3 Press and hold the [UTILITY] button, or press another button to cancel Utility.

---

## 4 Playback

---

### Playing Discs

The CDR1000 can play prerecorded audio CDs and unfinalized or finalized CD-R or CD-RW discs. Only Session 1 of a multi-session disc can be played.

- 1 Load the disc that you want to play.

See “Loading & Unloading Discs” on page 18 for more information.

- 2 Press the [PLAY] button.

Playback starts from the first track, the PLAY indicators light up, and the time counter starts counting.

Playback can also be started by using an optional footswitch. See “Using a Footswitch” on page 50 for more information.

The time counter can be set to display the elapsed playback time, remaining playback time, or total playback time. See “Setting the Time Display” on page 19 for more information.

### Pausing Playback

- 1 Press the [PAUSE] button to pause playback.

Playback pauses, the PLAY indicators go out, and the PAUSE indicator lights up.

- 2 Press the [PAUSE] or [PLAY] button to resume playback.

Playback resumes, the PAUSE indicator goes out, and the PLAY indicators light up.

The Search functions can be used while playback is paused. See “Searching” on page 24 for more information.

### Stopping Playback

- 1 Press the [STOP] button to stop playback.

Playback stops and the PLAY indicators go out.

Playback can also be stopped by using an optional footswitch. See “Using a Footswitch” on page 50 for more information.

Playback stops automatically when the end of the disc is reached.

## Playback Operation Table

The following table shows how various buttons operate in playback-related modes.

X = no change or invalid

Button	Operating mode			
	Disc tray open	Stop (disc tray closed)	Play	Playback pause
[OPEN/CLOSE]	Disc tray closes.	Disc tray opens.	Playback stops & the disc tray opens.	Play pause is cancelled and the disc tray opens.
[STOP]	X	X	Playback stops.	Play pause is cancelled.
[PLAY]	Disc tray closes & playback starts.	Playback starts. <sup>1</sup>	X	Playback resumes.
[PAUSE]	Disc tray closes & playback pauses.	Playback pauses at the top of the specified track.	Playback is paused.	Playback resumes.
PREV [◀◀]	The previous track is selected.	The previous track is selected but playback does not start.	The top of the current track is selected and playback resumes. Press repeatedly to select previous tracks.	The top of the current track is selected and playback pause resumes. Press repeatedly to select previous tracks.
NEXT [▶▶]	The next track is selected. <sup>2</sup>	The next track is selected but playback does not start.	The top of the next track is selected and playback resumes. Press repeatedly to select subsequent tracks.	The top of the next track is selected and playback pause resumes. Press repeatedly to select subsequent tracks.
INDEX [◀◀]	X	X	The top of the current index is selected and playback resumes. Press repeatedly to select previous indexes.	The top of the current index is selected and playback pause resumes. Press repeatedly to select previous indexes.
INDEX [▶▶]	X	X	The top of the next index is selected and playback resumes. Press repeatedly to select subsequent indexes.	The top of the next index is selected and playback pause resumes. Press repeatedly to select subsequent indexes.
SEARCH [◀◀]	X	X	Search backwards then resume playback.	Search backwards then resume playback pause.
SEARCH [▶▶]	X	X	Search forwards then resume playback.	Search forwards then resume playback pause.
Footswitch	X	Playback starts. <sup>1</sup>	Playback stops.	X
Remote Controller Number Keypad <sup>2</sup>	Disc tray closes and playback starts from the specified track.	Playback starts from the specified track.	The specified track is selected and played.	The specified track is selected and playback pause resumes.

1. Tracks can be selected using the [PREV] and [NEXT] buttons before starting playback.

2. If the specified track number is greater than the number of the last track, the last track is selected.

---

## Selecting Tracks

Tracks can be selected using the PREV [◀◀] and NEXT [▶▶] buttons during stop, playback, or playback pause.

- 1 Use the PREV [◀◀] button to select the top of the current track. Press again to select the top of the previous track.
- 2 Use the NEXT [▶▶] button to select the top of the next track. Press again to select the top of subsequent tracks.

The number of the selected track is displayed by the track counter.

## Selecting Tracks Directly

Tracks can be selected directly using the number keypad on the remote controller during stop, playback, or playback pause.

- 1 Use the number keypad on the remote controller to select tracks directly.  
Use buttons [1] through [9] to select tracks 1 through 9. To select track 3, for example, press button [3].  
To select tracks 10 and higher, use the [+10] button to enter the first digit and buttons [0] through [9] to enter the second digit. To select track 13, for example, press the [+10] button followed by the [3] button.

The number of the selected track is displayed by the track counter.

If the specified track number is greater than the number of the last track, the last track is selected.

## Selecting Indexes

Indexes can be selected using the previous INDEX [◀◀] and next INDEX [▶▶] buttons during playback or playback pause.

- 1 Use the previous INDEX [◀◀] button to select the top of the current index. Press again to select the top of the previous index.
- 2 Use the next INDEX [▶▶] button to select the top of the next index. Press again to select the top of subsequent indexes.

The number of the selected index is displayed by the index counter.

If the specified index cannot be found, the first index is selected.

## Searching

You can search the program material at high speed using the SEARCH [◀◀] and [▶▶] buttons during playback or playback pause.

- 1 Press and hold the backward SEARCH [◀◀] button to search backwards.

The CDR1000 searches backwards from the current position and the PLAY indicators go out. If the top of the current track is reached, searching continues into the previous track. If the top of the first track is reached, searching stops.

When the SEARCH [◀◀] button is released, the previous mode—playback or playback pause—is resumed and the relevant indicators light up.

- 2 Press and hold the forward SEARCH [▶▶] button to search forwards.

The CDR1000 searches forwards from the current position and the PLAY indicators go out. If the end of the current track is reached, searching continues into the next track. If the end of the last track is reached, searching stops.

While searching is in progress, playback signals are output by the ANALOG OUT and PHONES only, the AES/EBU OUT and COAXIAL OUT are muted.

## Using Repeat Playback

The CDR1000 provides three types of repeat playback: One-track Repeat, in which the current track plays repeatedly, All-track Repeat, which plays all tracks repeatedly, and A-B Repeat, which repeatedly plays the region between the specified A and B points.

### One-track Repeat Playback

- 1 Press the [REPEAT] button.

One-track Repeat playback starts and “REPEAT 1” appears on the display.

- 2 Press the [REPEAT] button twice to cancel One-track Repeat playback.

Normal playback resumes and “REPEAT 1” disappears from the display.

### All-track Repeat Playback

- 1 Press the [REPEAT] button twice.

All-track Repeat playback starts and “REPEAT ALL” appears on the display.

- 2 Press the [REPEAT] button to cancel All-track Repeat playback.

Normal playback resumes and “REPEAT ALL” disappears from the display.

### A-B Repeat Playback

- 1 Press the [A-B] button to set the A point.

The A point is set and “REPEAT A” appears on the display.

The A and B points can be in the same track or in different tracks.

- 2 Press the [A-B] button again to set the B point.

Playback repeats between the A and B points and “REPEAT AB” appears on the display.

- 3 Press the [A-B] button again to cancel A-B Repeat playback.

Normal playback resumes and “REPEAT AB” disappears from the display.

## 5 Recording

### Preparing to Record

The CDR1000 can record onto CD-R and CD-RW discs.

- 1 Load the disc to be used for recording.  
See “Loading & Unloading Discs” on page 18 for more information.
- 2 Select the input source.  
See “Selecting the Input Source” below for more information.
- 3 If recording via the AES/EBU IN or COAXIAL IN, set the sampling rate converter as necessary.  
See “Setting the Sampling Rate Converter” on page 26 for more information.
- 4 Set the Copy Bit as required.  
See “Setting the Copy Bit” on page 28 for more information.
- 5 Set the UV22 function as required.  
See “Setting the UV22” on page 28 for more information.
- 6 Set the Delay function as required.  
See “Setting the Input Delay” on page 27 for more information.
- 7 Proceed to Recording on page 29.

### Selecting the Input Source

The following input sources can be selected for recording: ANALOG IN, AES/EBU IN, or COAXIAL IN. The selected source is indicated on the display.

- 1 Use the [INPUT SELECT] button to select an input source.

Setting	Description
ANALOG	ANALOG IN (analog)
AES/EBU	AES/EBU IN (AES/EBU digital)
COAX	COAXIAL IN (S/PDIF digital)

When a digital input source is selected, the LOCK indicator lights up, indicating that the CDR1000 is locked to the incoming signal. If the CDR1000 cannot lock to the selected digital input source, the LOCK indicator flashes. If this unlocked condition continues for more than five seconds while recording, recording stops. If this happens, make sure that the source device is turned on and connected to the CDR1000 correctly, or select another input source. Recording via the AES/EBU IN or COAXIAL IN is not possible while the LOCK indicator is flashing.

## Setting the Sampling Rate Converter

The CDR1000 features a built-in sampling rate converter (SRC), which means digital sources at sampling rates other than 44.1 kHz, the standard for audio CDs, can be recorded.

The SRC can convert digital audio within the range 30–50 kHz.

When recording from a 44.1 kHz digital source, the CDR1000 locks to the sampling rate of the incoming signal. If the signal drifts by more than  $\pm 150$  ppm (parts per million), the CDR1000 automatically activates the sampling rate converter.

The Utility SRC parameter is used to set the sampling rate converter.

- 1 Use the [UTILITY] button to select "SRC."

The UTILITY indicator lights up and the SRC setting appears on the display.

- 2 Use the [PREV] or [NEXT] button to set the sampling rate converter to either "ON" or "AUTO."

Setting	Description
AUTO	The sampling rate converter is off unless the 44.1 kHz sampling rate of the selected digital input source varies by more than $\pm 150$ ppm, in which case it is activated automatically.
ON	The sampling rate converter is always on.

- 3 Press and hold the [UTILITY] button, or press another button to cancel Utility.

The SRC indicator lights up when the sampling rate converter is active, that is, when it's set to ON, or when it's set to AUTO and activated automatically.

The Utility SRC parameter should be set to ON when recording non-44.1 kHz digital sources, and set it to AUTO when recording 44.1 kHz digital sources. The SRC does not affect analog sources connected via the ANALOG IN.

*Note: When the sampling rate of the incoming signal nears the 150 ppm drift threshold, the SRC indicator may flash, in which case you should set the SRC parameter to ON.*



## Setting the Input Delay

By storing incoming audio in a buffer of between 0 and 4,950 ms before recording it to disc, the Input Delay function offers a “pre-record” facility, which can record a small section of audio before the point at which recording is started. When recording starts, the audio already in the buffer is recorded first, and when recording is stopped, the remaining audio in the buffer is recorded before recording actually stops. This is useful for recording, for example, live events where it can be difficult to predict the exact start of a performance, as it ensures that initial moments are not missed.

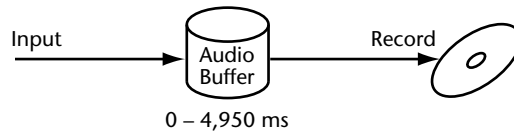

Input delay cannot be used with Sync Recording.

The Input Delay function is off when the Input Delay parameter is set to 0.

The following illustration shows the procedure for recording with input delay.

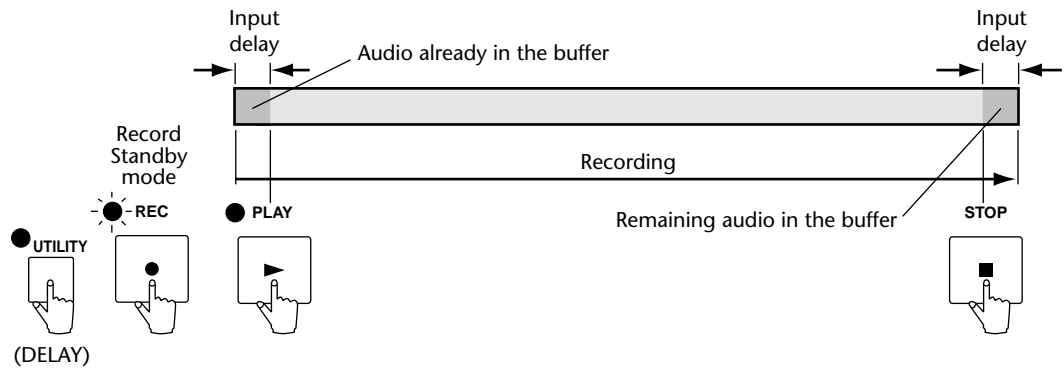

The Utility Delay parameter is used to set the delay time.

- 1 Use the [UTILITY] button to select “DELAY.”

The UTILITY indicator lights up and the Input Delay setting appears on the display.

- 2 Use the [PREV] or [NEXT] button to select a delay time.

Setting	Description
0, 66 ms, 132 ms, 198 ms, 264 ms, ..., 4950 ms	Delay time in milliseconds (0 = off).

- 3 Press and hold the [UTILITY] button, or press another button to cancel Utility.

While recording with the Input Delay function, in Elapse time mode, the counter displays the time since recording started plus the specified input delay.

## Setting the UV22

The CDR1000 employs the popular UV22 Super CD Encoding system. Developed by Apogee Electronics Corporation in the United States, and commonly used for wordlength truncation in CD mastering applications, UV22 preserves the sonic detail present in 20- and 24-bit digital audio during the conversion to 16-bit audio, without the side effects of earlier wordlength-reduction techniques, such as digital dither, noise shaping, and bit mapping.

- 1 Press the [UV22] button to turn on UV22 processing.

The UV22 indicator lights up.

- 2 Press the [UV22] button again to turn off UV22 processing.

The UV22 indicator goes out.

Discs recorded using UV22 can be played just like any other disc on standard CD players.

## Setting the Copy Bit

In addition to digital audio, Copy Bit information, which determines whether or not digital copying is permitted, is written to disc during recording. Consumer-type CD, MD, or DAT recorders check the Copy Bit information when recording via their COAXIAL (or optical) input. If the Copy Bit is set to PROTECT, digital recording via the COAXIAL input is not possible. If the Copy Bit is set to PERMIT, however, recording is possible. The Copy Bit can also be set to ONCE, which means that digital copying is possible, but digitally made copies cannot be used to make additional digital copies.

- 1 Use the [UTILITY] button to select “COPY.”

The UTILITY indicator lights up and the Copy Bit setting appears on the display.

- 2 Use the [PREV] or [NEXT] button to select a Copy Bit setting.

Setting	Description
PERMIT	Any number of digital copies can be made and the copies can be used to make additional digital copies.
PROTECT	No digital copies can be made.
ONCE	Any number of digital copies can be made but the copies CANNOT be used to make additional digital copies.

- 3 Press and hold the [UTILITY] button, or press another button to cancel Utility.

## Recording

This section explains how to record.

The following illustration shows the procedure for recording.

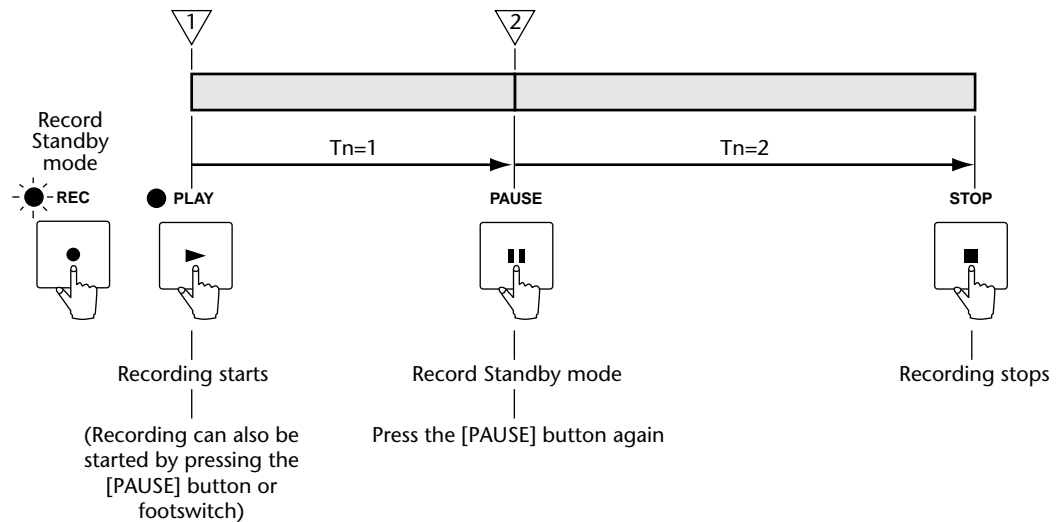

- 1 Prepare for recording as explained on page 25.
- 2 From stop, press the [REC] button to engage Record Standby mode.
 

Record Standby mode is engaged, the PAUSE indicator lights up, and the REC indicators flash. If the loaded disc is a blank disc, track 1 is selected for recording. If it's a partially recorded disc, the next available track is selected.

The time counter can be set to display the elapsed record time, remaining record time, or total record time. See "Setting the Time Display" on page 19 for more information.

In Record Standby mode, the selected input source can be monitored via the ANALOG OUT, AES/EBU OUT, COAXIAL OUT, or PHONES, and metered on the CDR1000 level meters.

You can cancel Record Standby mode by pressing the [STOP] button.
- 3 If recording via the ANALOG IN, use the REC LEVEL control to set the recording level in conjunction with the level meters.
 

The recording level can be set independently for the left and right channels. The recording level for the AES/EBU IN and COAXIAL IN is determined by the source and cannot be set on the CDR1000.

A two-second mute can be inserted at the beginning of a track by using the Rec Mute function. See "Inserting a Two-second Mute" on page 35 for more information.
- 4 Press the [PLAY] or [PAUSE] button to start recording.
 

Recording starts, the PAUSE indicator goes out, the REC indicators light up continuously, the PLAY indicators light up, and the time counter starts counting. If the Fade In function is set, fade in processing is performed. See "Applying a Fade In" on page 37 for more information.

Recording can also be started by using an optional footswitch. See "Using a Footswitch" on page 50 for more information.

- 5 Use the [TRACK INC] and [INDEX INC] buttons to increment the track and index counters.

See “Incrementing Track Numbers Manually” on page 32 and “Incrementing Index Numbers Manually” on page 33 for more information.

- 6 Press the [PAUSE] button to pause recording.

Record Standby mode is engaged. The PAUSE indicator lights up, the REC indicators flash, and the PLAY indicators go out. If the Rec Mute or Fade Out function is set, mute or fade out processing is performed when the [PAUSE] button is pressed. See “Inserting a Two-second Mute” on page 35 and “Applying a Fade Out” on page 38 for more information.

- 7 Press the [PLAY] or [PAUSE] button to resume recording.

Recording starts, the track number is incremented, the PAUSE indicator goes out, the REC indicators light up continuously, the PLAY indicators light up, and the time counter starts counting. If the Fade In function is set, fade in processing is performed.

- 8 Press the [STOP] button to stop recording.

If the Rec Mute or Fade Out function is set, mute or fade out processing is performed, recording stops, the REC and PLAY indicators go out, and “WAIT” appears on the display while the PMA is written.

Recording stops automatically if the end of the disc is reached, and can also be stopped by using an optional footswitch. See “Using a Footswitch” on page 50 for more information.

## Recording Operation Table

The following table shows how various buttons operate in recording-related modes.

X = no change or invalid

Button	Operating mode				
	Stop	Record Standby	Recording	One-track Sync Record	All-track Sync Record
[STOP]	X	Record Standby mode is cancelled.	Recording stops.	Recording stops (Sync Recording mode is cancelled).	Recording stops (Sync Recording mode is cancelled).
[PAUSE]	X	Recording starts.	Record Standby mode is engaged.	Recording stops (Sync Recording mode is cancelled).	Record Standby mode is engaged (Sync Recording mode is cancelled).
[PLAY]	Playback starts.	Recording starts.	X	X	X
[REC]	Record Standby mode is engaged.	X	X	X	X
[REC MUTE]	X	Rec Mute Standby mode is engaged.	Rec Mute Standby mode is engaged.	Two-second mute is inserted at end of track when recording is paused or stopped.	X
[TRACK INC]	X	X	Track number is incremented.	X	X
[INDEX INC]	X	X	Index counter is incremented.	X	X
[SYNC REC]	One-track Sync Recording Standby mode is engaged.	X	X	X	X
Footswitch	X	Recording starts.	Recording stops.	X	X

## Incrementing Track Numbers Manually

The track number can be incremented manually during recording using the Track Increment function. When the [TRACK INC] button is pressed, the track number is incremented and the Track Number is written to disc. Track Numbers are written to disc 300 ms before the point at which the [TRACK INC] button is pressed. This is to compensate for the time that it takes a human operator to press the button upon hearing the position at which the Track Number should be incremented, and helps to ensure that Track Numbers are written just before the start of each track.

The following illustration shows the procedure for incrementing track numbers manually while recording.

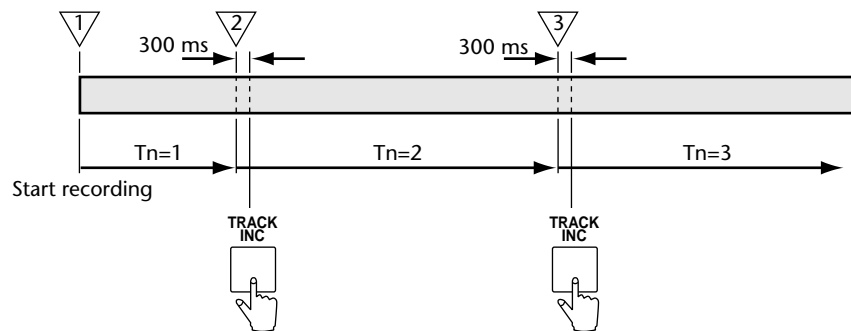

- 1 Start recording, as explained on page 29.  
If the loaded disc is a blank disc, track 1 is selected for recording. If it's a partially recorded disc, the next available track is selected.
- 2 While recording is in progress, press the [TRACK INC] button to increment the track number.

The track number is incremented and the Track Number is written to disc.

The track number cannot be incremented manually when Auto Rec/Track or Sync Recording is used.

## Incrementing Index Numbers Manually

The index number can be incremented manually during recording using the Index Increment function. When the [INDEX INC] button is pressed, the index counter is incremented and the Index Number is written to disc. Index Numbers are written to disc 300 ms before the point at which the [INDEX INC] button is pressed. This is to compensate for the time that it takes a human operator to press the button upon hearing the position at which the Index Number should be incremented.

The following illustration shows the procedure for incrementing index numbers manually while recording.

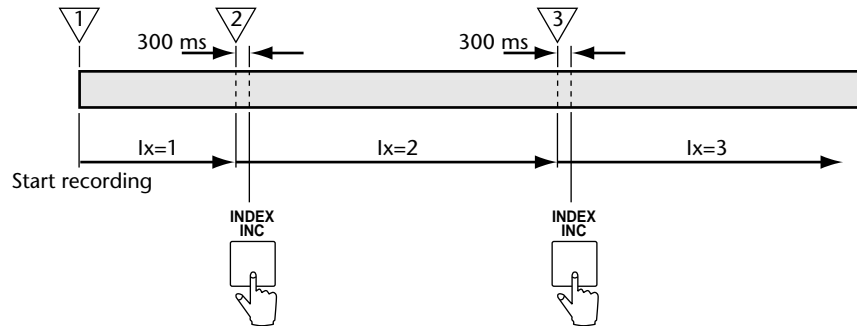

- 1 Start recording, as explained on page 29.

Each track starts from Index Number 1.

- 2 While recording is in progress, press the [INDEX INC] button to increment the index counter.

The index counter is incremented and the Index Number is written to disc.

The index number cannot be incremented manually when Auto Rec/Track or Sync Recording is used.

## Using Auto Rec Start & Track Increment

Recording can be started automatically, and track numbers incremented automatically using the Auto Rec/Track function, which monitors the selected input source and starts recording from Record Standby mode when the signal level exceeds the specified threshold, and subsequently increments the track number when the signal level exceeds the specified threshold after being below it for three or more seconds.

Auto Rec/Track cannot be used with Sync Recording.

The following illustration shows the procedure for recording with the Auto Rec/Track function.

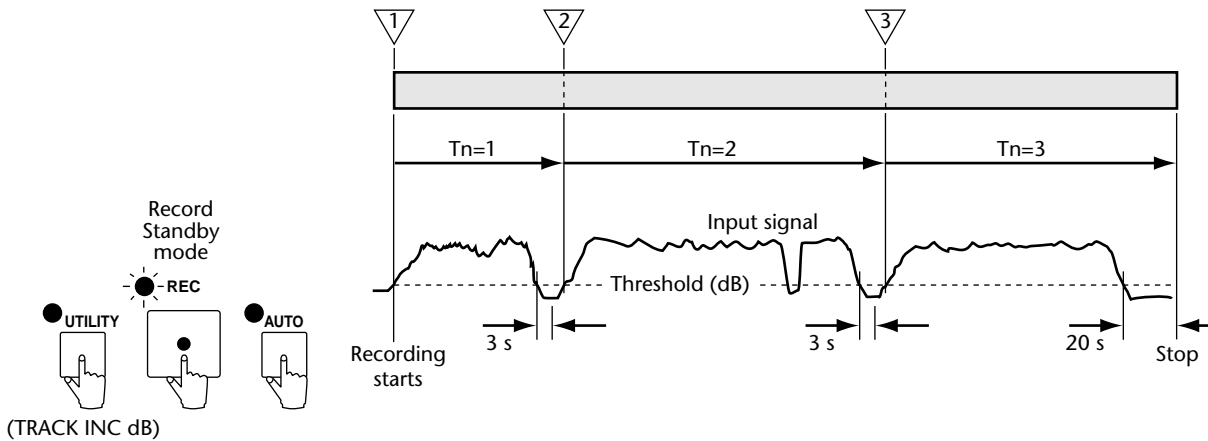

The Utility TRACK INC dB parameter is used to set the threshold level.

- 1 Use the [UTILITY] button to select "TRACK INC dB."

The UTILITY indicator lights up and the TRACK INC dB setting appears on the display.

- 2 Use the [PREV] or [NEXT] button to set the TRACK INC dB parameter.

Threshold	Description
-30, -35, -40, -45, -50, -55, -60, -65, -70, -96	Auto Rec/Track threshold in dB.

- 3 Press and hold the [UTILITY] button, or press another button to cancel Utility.
- 4 From stop, press the [REC] button to engage Record Standby mode.  
See page 29 for more information on Record Standby mode.
- 5 Press the [AUTO] button to turn on the Auto Rec/Track function.

The AUTO indicator lights up.

When the input signal level exceeds the specified threshold, recording starts automatically. When the signal level exceeds the specified threshold after being below it for three or more seconds, the track number is incremented automatically.

If the level of the input signal is below the specified threshold for 20 seconds or more, recording stops. You can prevent this by pressing the [AUTO] button to turn off the Auto Rec/Track function.

- 6 Press the [AUTO] button again to cancel the Auto Rec/Track function.

The AUTO indicator goes out.



## Inserting a Two-second Mute

A two-second mute, or silent section can be inserted at the beginning or end of each track. To insert a mute at the beginning of a track, Rec Mute Standby mode is engaged by pressing the [REC MUTE] button while the CDR1000 waits in Record Standby mode, the mute is then inserted when recording starts. To insert a mute at the end of a track, Rec Mute Standby mode is engaged by pressing the [REC MUTE] button during recording, the mute is then inserted when recording is stopped in the normal way by pressing the [PAUSE] button, [STOP] button, or footswitch. If the Fade Out function is set, the mute is inserted after the fade out.

Rec Mute can be used with One-track Sync Recording, but not with All-track Sync Recording.

Rec Mute cannot insert a two-second mute at the beginning of track 1, since a mute is inserted there automatically.

### Inserting a Mute at the Beginning of a Track

The following illustration shows the procedure for inserting a mute at the beginning of a track.

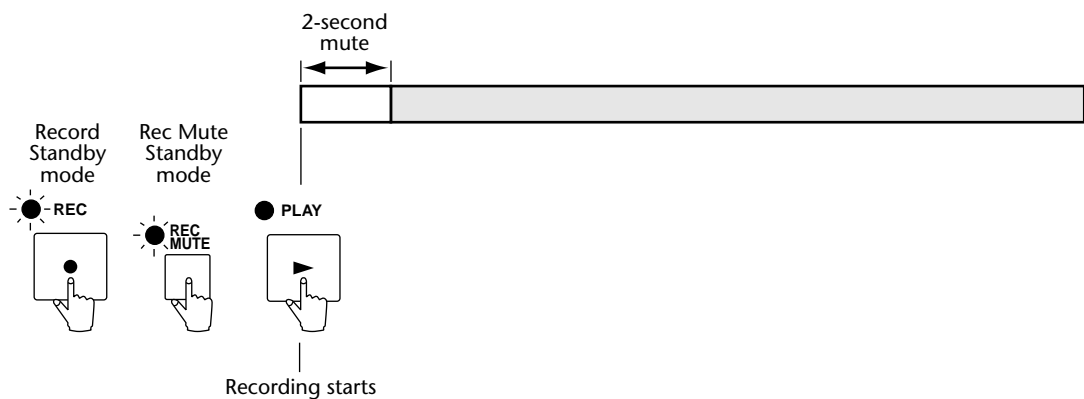

- 1 Engage Record Standby mode, as explained on page 29.

See page 40 for information on engaging Record Standby mode with One-track Sync Recording.

- 2 Press the [REC MUTE] button.

Rec Mute Standby mode is engaged and the REC MUTE indicator flashes.

- 3 Start recording.

A two-second silent section is inserted and then the REC MUTE indicator goes out

Only one mute can be inserted at the beginning of each track. Technically speaking, the mute is inserted into Index 0.

## Inserting a Mute at the End of a Track

The following illustration shows the procedure for inserting a mute at the end of a track.

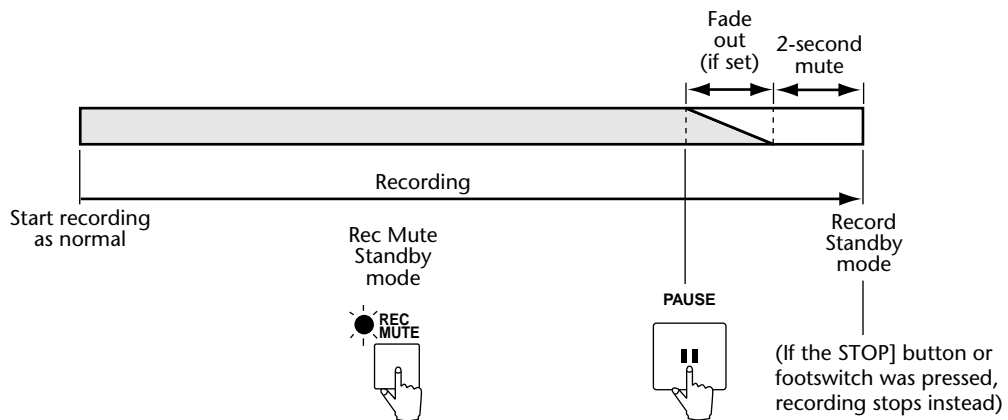

- 1 Start recording, as explained on page 29.  
See page 40 for information on inserting a mute with One-track Sync Recording.
- 2 While recording, press the [REC MUTE] button.  
Rec Mute Standby mode is engaged and the REC MUTE indicator flashes.
- 3 Press the [PAUSE] button to engage Record Standby mode, or press the [STOP] button or footswitch to stop recording.  
A two-second silent section is inserted and then the REC MUTE indicator goes out. If the Fade Out function is set, the mute is inserted after the fade out.

## Applying a Fade In

A fade in can be applied at the start of each track using the Fade In function. The length of the fade in can be set from 1 to 10 seconds in single second steps using the Fade In parameter. The fade in begins when recording is started from Record Standby mode by pressing the [PLAY] button, [PAUSE] button, or footswitch.

The Fade In function is off when the Fade In parameter is set to 0.

When the Input Delay function is set, the fade in starts with the digital audio already in the audio buffer. See “Setting the Input Delay” on page 27 for more information.

Fade In cannot be used with Sync Recording.

The following illustration shows the procedure for applying a fade in.

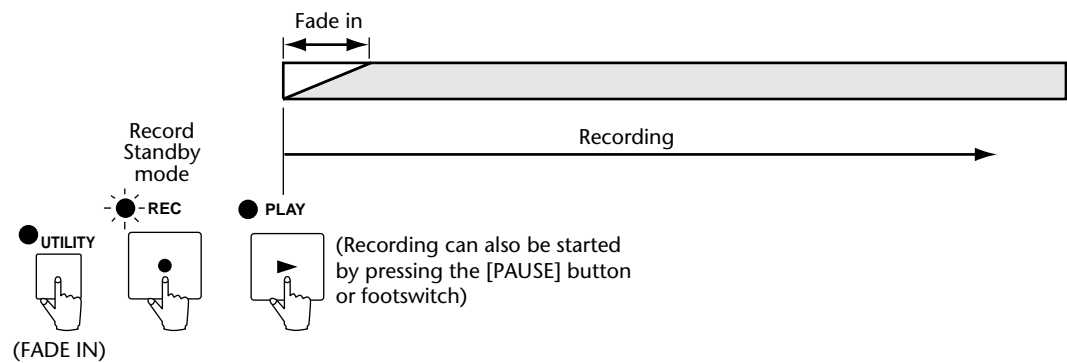

The Utility Fade In parameter is used to set the fade in time.

- 1 Use the [UTILITY] button to select “FADE IN.”  
The UTILITY indicator lights up and the Fade In setting appears on the display.
- 2 Use the [PREV] or [NEXT] button to select a fade in time.

Setting	Description
0–10 s	Fade in time in seconds (0 = off).

- 3 Press and hold the [UTILITY] button, or press another button to cancel Utility.  
A fade in will be applied each time recording is started from Record Standby mode by pressing the [PLAY] button, [PAUSE] button, or footswitch. See page 29 for more information of recording.
- 4 To turn off the Fade In function, set the Utility Fade In parameter to 0.

## Applying a Fade Out

A fade out can be applied at the end of each track using the Fade Out function. The length of the fade out can be set from 1 to 10 seconds in single second steps using the Fade Out parameter. The fade out begins when recording is stopped by pressing the [PAUSE] button, [STOP] button, or footswitch.

The Fade Out function is off when the Fade Out parameter is set to 0.

Fade Out cannot be used with Sync Recording.

The following illustration shows the procedure for applying a fade out.

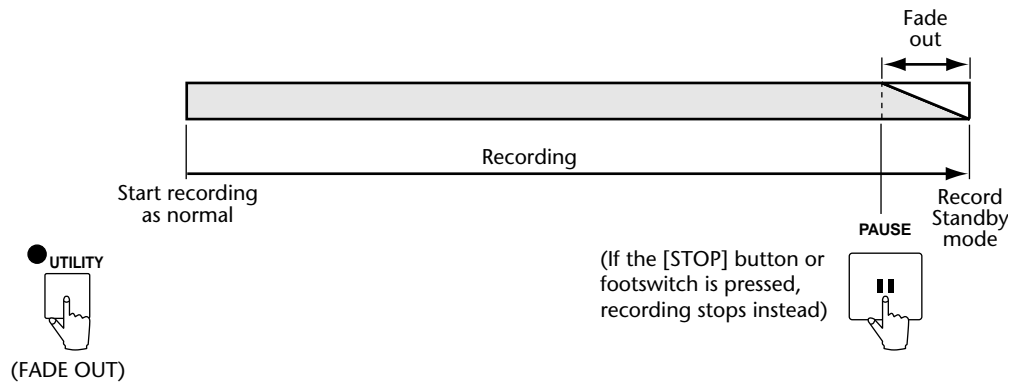

The Utility Fade Out parameter is used to set the fade out time.

- 1 Use the [UTILITY] button to select “FADE OUT.”

The UTILITY indicator lights up and the Fade Out setting appears on the display.

- 2 Use the [PREV] or [NEXT] button to select a fade out time.

Setting	Description
0–10 s	Fade out time in seconds (0 = off).

- 3 Press and hold the [UTILITY] button, or press another button to cancel Utility.

A fade out will be applied each time recording stopped by pressing the [PAUSE] button, [STOP] button, or footswitch. See page 29 for more information of recording.

“FADE OUT” appears on the display while the fade out is in progress. Other buttons are inactive at this time.

- 4 To turn off the Fade Out function, set the Utility Fade Out parameter to 0.

---

## Sync Recording from CD, MD, or DAT

In addition to audio data, COAXIAL (S/PDIF) format digital signals also transmit Track Number, Index Number, Start ID, and Skip ID information, which the CDR1000 can use to start and stop recording and increment the track and index counters. This is convenient when recording material from a CD, MD, or DAT player. The CDR1000 features two Sync Recording modes: One-track Sync Recording and All-track Sync Recording.

In One-track Sync Recording mode, individual tracks can be recorded one at a time, with the CDR1000 starting recording automatically when a Track Number or Start ID is received, incrementing the index number as and when Index Numbers are received, and then stopping automatically when the next Track Number, Start ID, or Skip ID is received. When recording from MD, the CDR1000 starts recording automatically when it detects the start of the audio material, also MD does not support Index Numbers.

In All-track Sync Recording mode, an entire CD or MD, or several DAT tracks can be recorded, with the CDR1000 starting recording automatically when a Track Number or Start ID is received, incrementing the track and index numbers as and when Track and Index Numbers are received, and then stopping automatically after 20 seconds of no input signal.

CD and MD players transmit Track and Index Numbers as and when they occur on a disc. Technically speaking, the CDR1000 track number is incremented when the Index Number changes from 0 to 1, which indicated the start of a track, not the end of the previous track.

DAT players transmit Start and Skip IDs as and when they occur on a tape. Skip IDs are ignored in All-track Sync Recording mode, but cause the CDR1000 to stop when used with One-track Sync Recording. Since recording does not start instantaneously, when compiling a DAT source tape, position the Start IDs slightly before the beginning of each track to ensure that the first note is not cut off.

The CDR1000 starts recording when it receives a Track Number or Start ID from the source device (e.g., CD, MD, or DAT player). CD and MD players must be stopped or paused at the top of the track to be recorded, as Sync Recording cannot be started while the source device is playing. For DAT players, playback needs to be started from before the Start ID.

During Sync Recording, if no input signal is received for more than 20 seconds, recording stops automatically.

AES/EBU digital signals do not transmit Track Number, Index Number, Start ID, and Skip ID information, so only the COAXIAL IN can be used for Sync Recording.

The Rec Mute function can be used with One-track Sync Recording, but not All-track Sync Recording. Fade In and Fade Out cannot be used with either mode.

The Auto Finalize function can be used to automatically finalize discs when Sync Recording stops.

## One-track Sync Recording

This section explains how to use One-track Sync Recording.

The following illustration shows the procedure for One-track Sync Recording.

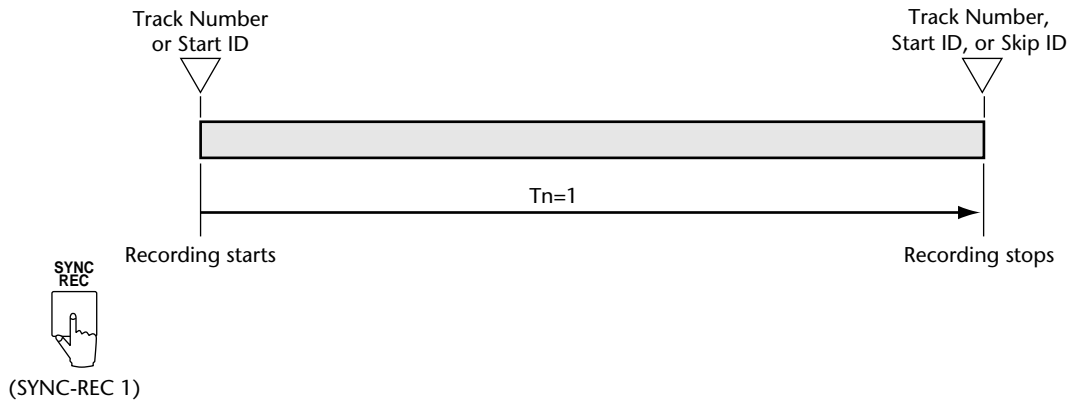

- 1 Prepare for recording, as explained on page 25, setting the input source to COAX, but instead of proceeding to the Recording section, proceed as follows.
- 2 From stop, press the [SYNC REC] button.

Record Standby mode is engaged, “SYNC-REC 1” appears on the display, the PAUSE indicator lights up, and the REC indicators flash. If the loaded disc is a blank disc, track 1 is selected for recording. If it’s a partially recorded disc, the next available track is selected.

The LOCK indicator should appear, indicating that the CDR1000 is locked to the incoming digital signal. Sync Recording is not possible if the LOCK indicator does not light up or is flashing. See “Selecting the Input Source” on page 25 for more information.

In Record Standby mode, the selected input source can be monitored via the ANALOG OUT, AES/EBU OUT, COAXIAL OUT, or PHONES, and metered on the CDR1000 level meters.

You can cancel One-track Sync Recording at anytime by pressing the [STOP] button.

A two-second mute can be inserted at the beginning of the track by using the Rec Mute function. See “Inserting a Two-second Mute” on page 35 for more information.

Discs can be finalized automatically when Sync Recording is stopped, using the Auto Finalize function. Press the [SYNC REC] button while Record Standby mode is engaged to turn on the Auto Finalize function. “AUTOFINALIZE” appears on the display. Press again to cancel Auto Finalize. See page 44 for more information on finalizing discs.

- 3 Prepare the source CD, MD, or DAT player so that it’s ready to play the track that you want to record.

The CDR1000 will start recording when it receives a Track Number or Start ID. CD or MD players must be stopped or paused at the top of the track to be recorded, as Sync Recording cannot be started while the source device is playing.

---

4 Start playback on the CD, MD, or DAT player.

Recording starts, the PAUSE indicator goes out, the REC indicators light up continuously, the PLAY indicators light up, and the time counter starts counting. The index counter is incremented as and when Index Numbers are received.

*Note: If no input signal is received for 20 seconds or more during Sync Recording, Recording stops automatically.*

When the next Track Number, Start ID, or Skip ID is received, the [PAUSE] button or [STOP] button pressed, the CDR1000 stops recording and cancels One-track Sync Recording mode. If the Rec Mute function is set, mute processing is performed. "SYNC-REC 1" disappears from the display, all lit indicators go out, and "WAIT" appears on the display while the PMA is written.

To record another track using One-track Sync Recording, repeat steps 3 through 4. If the Auto Finalize function is on, the disc is finalized automatically.

## All-track Sync Recording

This section explains how to use All-track Sync Recording.

The following illustration shows the procedure for All-track Sync Recording.

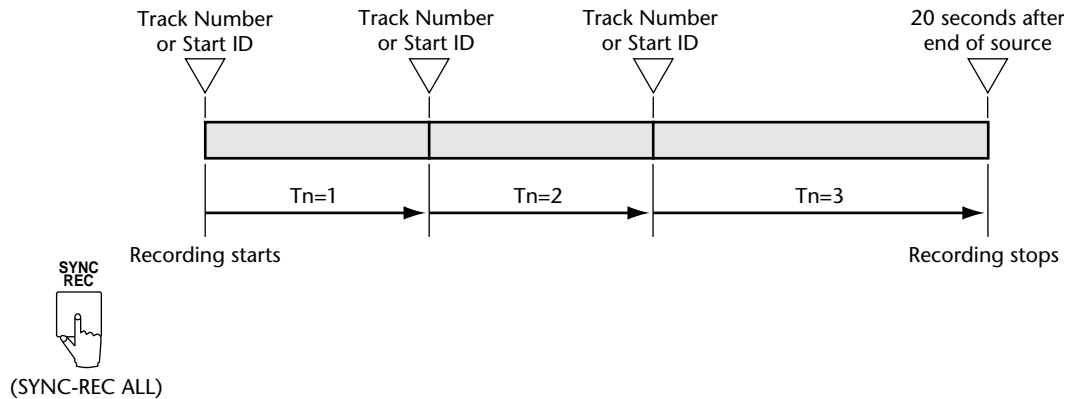

- 1 Prepare for recording, as explained on page 25, setting the input source to COAX, but instead of proceeding to the Recording section, proceed as follows.
- 2 From stop, press the [SYNC REC] button.

Record Standby mode is engaged, “SYNC-REC 1” appears on the display, the PAUSE indicator lights up, and the REC indicators flash. If the loaded disc is a blank disc, track 1 is selected for recording. If it’s a partially recorded disc, the next available track is selected.

- 3 Use the [PREV] and [NEXT] button to select All-track Sync Recording mode. “SYNC-REC ALL” appears on the display.

You can cancel All-track Sync Recording at anytime by pressing the [STOP] button.

The LOCK indicator should appear, indicating that the CDR1000 is locked to the incoming digital signal. Sync Recording is not possible if the LOCK indicator does not light up or is flashing. See “Selecting the Input Source” on page 25 for more information.

In Record Standby mode, the selected input source can be monitored via the ANALOG OUT, AES/EBU OUT, COAXIAL OUT, or PHONES, and metered on the CDR1000 level meters.

Discs can be finalized automatically when Sync Recording is stopped, using the Auto Finalize function. Press the [SYNC REC] button while Record Standby mode is engaged to turn on the Auto Finalize function. “AUTOFINALIZE” appears on the display. Press again to cancel Auto Finalize. See page 44 for more information on finalizing discs.

- 4 Start playback on the CD, MD, or DAT player.

Recording starts, the PAUSE indicator goes out, the REC indicators light up continuously, the PLAY indicators light up, and the time counter starts counting. The track and index numbers are incremented as and when Track and Index Numbers are received.

*Note: If no input signal is received for 20 seconds or more during Sync Recording, Recording stops automatically.*



If the [STOP] button or [PAUSE] button is pressed, or no input signal is received for more than 20 seconds, Sync Recording is cancelled, the CDR1000 does not wait in Record Standby mode, and all lit indicators go out.

If the Auto Finalize function is on, the disc is finalized automatically.

## Finalizing Discs

The Finalization function reads the temporary table of contents stored in the PMA, and writes the final TOC to disc, so that discs can be played on standard CD players.

Unfinalized CD-R discs can be played on other CD-R recorders. Once finalized, CD-R discs cannot be used for additional recording and are fixed for life.

Unfinalized CD-RW discs can be played on other CD-RW recorders, but cannot be played on CD-RW-compatible CD players until they have been finalized. Unlike CD-R discs, CD-RW discs can be erased. You can erase the last track or erase the entire disc.

### 1 From stop, press the [FINALIZE] button.

Finalize Standby mode is engaged, “FINALIZE” flashes on the display, and the REC indicators flash.

If the next step is not performed within four seconds, Finalize Standby mode is cancelled.

### 2 Press the [PLAY] button to start finalization.

Finalization starts, “FINALIZING” appears on the display, the REC indicators light up continuously, and the PLAY indicators flash.

The time remaining to complete the finalization process counts down on the display in minutes and seconds. No other CDR1000 functions can be used while Finalization is in progress. With discs that support recording at 4x normal speed, finalization takes place at 4x normal speed.

When the finalization process is finished, the REC and PLAY indicators go out and “FINALIZING” disappears from the display.

## Erasing Discs (CD-RW only)

CD-RW discs can be erased using the three Erasure functions: Last Track Erase, Disk Erase, and Initialize Erase. Last Track Erase erases the control data of last recorded track on unfinalized discs. Tracks can be erased one at a time by repeating the Track Erase function. Disk Erase erases the control data of all tracks quickly, so the entire disc can be used again. Initialize erases not only the control data of all tracks but the entire program area too. Initialize Erase is recommended for discs that were previously used to store data tracks.

- 1 From stop, press the [ERASE] button.

Erase Standby mode is engaged, “ERASE xxxx” flashes on the display (“xxxx” being the selected Erase function), and the REC indicators flash.

If the next step is not performed within four seconds, Erase Standby mode is cancelled.

- 2 Use the [PREV] and [NEXT] button to select an Erasure function.

Functions	Description
TRACK	Erases the last recorded track
DISC	Erases all tracks on the disc quickly
INITIALIZE	Erases all tracks and initializes the entire disc

The selected mode appears on the display.

You can cancel Erase Standby mode by pressing the [STOP] button.

- 3 Press the [PLAY] button to start erasure.

Erasure starts, “ERASING” appears on the display, the REC indicators light up continuously, and the PLAY indicators flash.

The time remaining to complete the erasure process counts down on the display in minutes and seconds. No other CDR1000 functions can be used while erasure is in progress. With discs that support recording at 4x normal speed, erasure takes place at 4x normal speed.

When the erasure process is finished, the REC and PLAY indicators go out and “ERASING” disappears from the display.

If an error message appears when using the Initialize erase function, run the function again.

Auto Unfinalize allows you to record additional tracks to finalized CD-RW discs. When a finalized CD-RW disc is loaded, and a new track is selected for recording in the normal way, the disc is unfinalized automatically and recording carried out as normal. It takes about one minute to unfinalize a disc, during which time “WAIT” appears on the display.

## 6 Other Functions

### Selecting the AES/EBU OUT Playback Clock

When recording, the AES/EBU OUT outputs digital audio at 44.1 kHz. For playback, however, the AES/EBU OUT can be wordclock locked to an external wordclock source. If the selected wordclock source is not running at 44.1 kHz, the CDR1000's built-in sampling-rate converter converts the 44.1 kHz audio from the CD up or down accordingly. This is useful when CD material needs to be transferred to a digital audio system in which all digital audio equipment is locked to a common wordclock.

The COAXIAL OUT always outputs digital audio at 44.1 kHz.

The Utility Playback Clock parameter is used to set the AES/EBU OUT playback clock.

- 1 Use the [UTILITY] button to select "CLK SEL."

The UTILITY indicator lights up and the Playback Clock setting appears on the display.

- 2 Use the [PREV] and [NEXT] buttons to select the Playback Clock.

Setting	Description
INT	AES/EBU OUT wordclock derived internally (fixed at 44.1 kHz).
WORD	AES/EBU OUT wordclock derived from the WORD CLOCK IN.
AES	AES/EBU OUT wordclock derived from the AES/EBU IN. If the input source is set to COAX, record monitoring is not possible via the AES/EBU OUT.
COAX	AES/EBU OUT wordclock derived from the COAXIAL IN. If the input source is set to AES/EBU, record monitoring is not possible via the AES/EBU OUT.

- 3 Press and hold the [UTILITY] button, or press another button to cancel Utility.

In the following example, the CDR1000 is used in conjunction with a digital multitrack recorder and digital mixing console, as the playback source for CD material. Digital audio is transferred from the CDR1000 to the digital mixing console via an AES/EBU digital connection. The digital multitrack recorder is the wordclock master, and the digital mixing console and CDR1000 are wordclock slaves. In order to record from a conventional CD player, the wordclock setup would have to be reconfigured so that the CD player was the wordclock master and the digital multitrack recorder and digital mixing console were wordclock slaves. The CDR1000's ability to lock the AES/EBU OUT to an external wordclock source, however, eliminates the need to reconfigure the system.

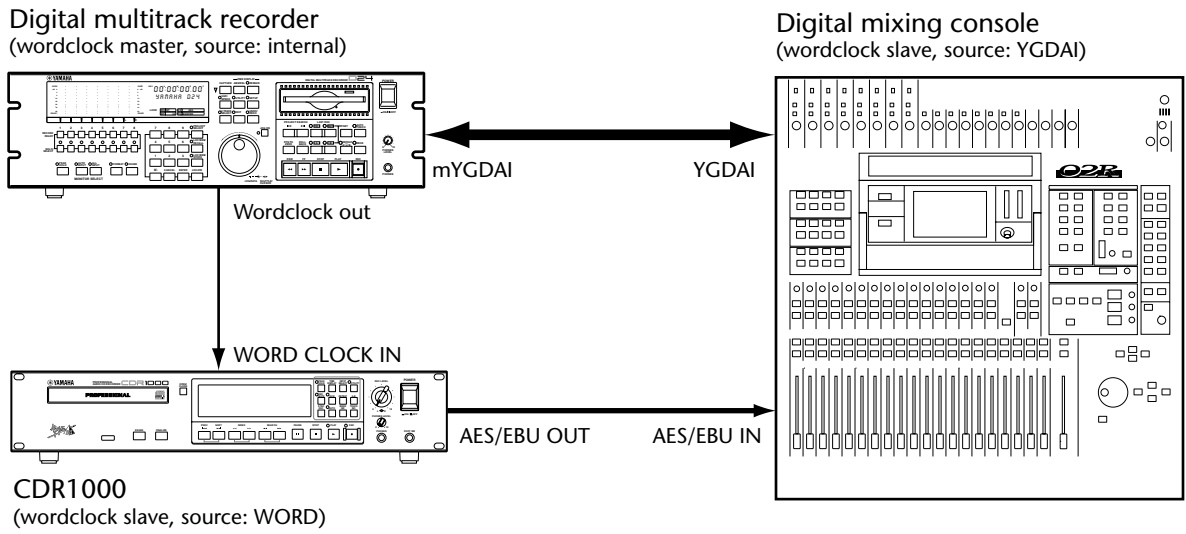

*Note: If the message "OUT OF RANGE" appears while monitoring, stop and reset the sampling rate.*

## Using Digital Output Thru

The AES/EBU OUT and COAXIAL OUT can be set so that they output playback and monitor signals, or signals received at the AES/EBU IN and COAXIAL IN respectively. This is useful when two CDR1000s are used to record the same digital source.

The Utility Digital Out parameter is used to set the digital outputs.

- 1 Use the [UTILITY] button to select "D-OUT."
- The UTILITY indicator lights up and the Digital Out setting appears on the display.
- 2 Use the [PREV] and [NEXT] buttons to select either "NORMAL" or "THRU."

Setting	Description
<b>NORMAL</b>	The AES/EBU OUT and COAXIAL OUT output playback and monitor signals.
<b>THRU</b>	The AES/EBU OUT and COAXIAL OUT output the signals received at the AES/EBU IN and COAXIAL IN respectively.

- 3 Press and hold the [UTILITY] button, or press another button to cancel Utility.

In this example, several CDR1000s are used for disc duplication. The source machine is a standard CD player with a coaxial output. Alternatively, the source machine could be an MD or DAT player. The Utility Digital Out parameter on each CDR1000 is set to THRU, so that digital audio received at the COAXIAL IN connector is fed directly through to the COAXIAL OUT and onto the next CDR1000.

Track and Index Numbers from the CD player are transmitted together with the digital audio via the coaxial connections, for synchronized recording. See page 39 for more information.

Use only phono cables with a 75Ω impedance for coaxial connections. Using ordinary audio cables can cause digital audio transmission errors.

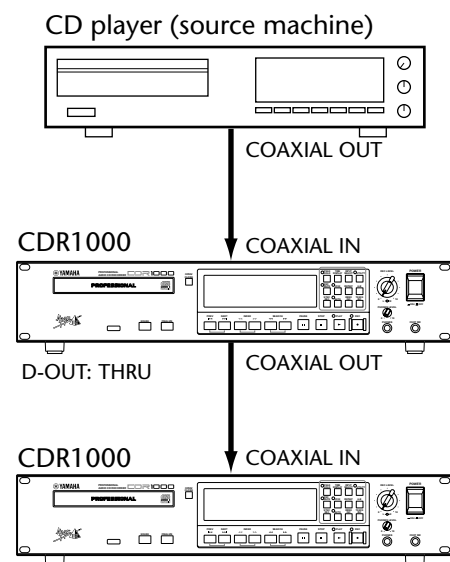

This example is similar to the previous one except that the digital connections are AES/EBU instead of coaxial. Each CDR1000 is controlled using the custom-built control system, which is connected to the PARALLEL port on each. Functions that can be controlled via the PARALLEL port include Play, Pause, Stop, Record Standby, and Track Increment. See page 51 for more information.

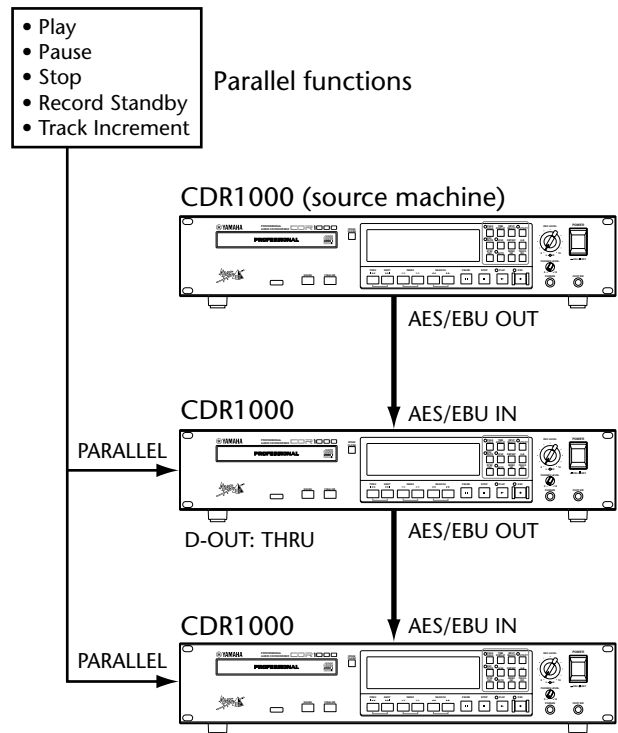

## Using a Footswitch

An optional footswitch, such as the Yamaha FC5, can be connected to the FOOT SW jack and used to stop and start playback and recording. Footswitch operation depends on the current mode, as shown in the following table.

Current Mode	Footswitch Operation
Stop	Playback starts from the selected track number. <sup>1</sup>
Playback	Playback stops.
Record Standby	Recording starts. <sup>2</sup>
Recording	Recording stops. <sup>2</sup>

1. Tracks can be selected using the [PREV] and [NEXT] buttons before starting playback.
2. Footswitch operation is ignored when using Sync Recording.

## Disabling the Remote Controller

The remote controller can be disabled using the Utility Remote parameter, thereby preventing accidental operation.

- 1 Use the [UTILITY] button to select "REMOTE."  
The UTILITY indicator lights up and the Remote setting appears on the display.
- 2 Use the [PREV] and [NEXT] buttons to select either "ON" or "OFF."

Setting	Description
ON	The remote controller operates as normal.
OFF	Commands transmitted by the remote controller are ignored.

- 3 Press and hold the [UTILITY] button, or press another button to cancel Utility.



## Using the Parallel Port

The PARALLEL port is a general purpose interface that provides remote control access to various CDR1000 functions, including Play, Pause, Stop, Record Standby, and Track Increment. By using custom built switches and cables, it can be used for simultaneous control of several CDR1000s in a multiple disc recording, or disc duplication system.

In addition to receiving trigger signals, the CDR1000 also outputs trigger signals when the following functions are operated: Play, Pause, and Stop.

The following diagram shows a switching arrangement for the input triggers.

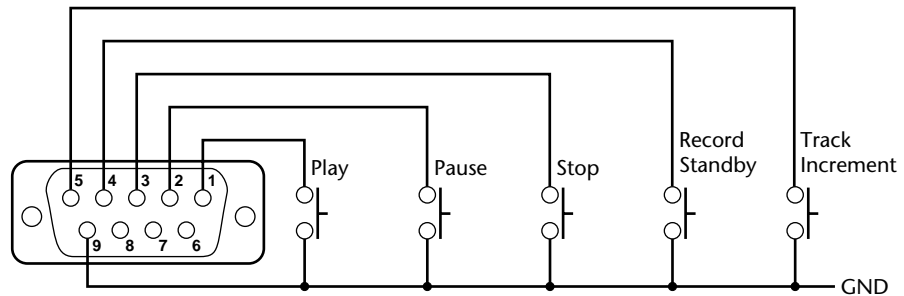

### Parallel Port Pin Configuration

The following table shows how the PARALLEL port is wired.

Pin	I/O	Signal
1	Input	Play
2		Pause
3		Stop
4		Record Standby
5		Track Increment
6	Output	Play
7		Pause
8		Stop
9		GND

- Input trigger pulses must be 50 ms or longer.
- Each output trigger pulse is 500 ms.
- All outputs are open collector.

# Troubleshooting

Symptom	Advice
Cannot turn on the CDR1000.	Make sure that the power cord is connected to a suitable AC wall outlet. See "Connecting the Power Cord" on page 16 for more information.
	Make sure that the CDR1000 POWER switch is set to the ON position. See "Turning On the Power" on page 16 for more information.
	If you still cannot turn on the CDR1000, contact your Yamaha dealer.
Cannot use the remote controller.	Make sure that the batteries are installed correctly. See "Using the Remote Controller" on page 19 for more information.
	Make sure the Utility Remote parameter is set to ON. See "Disabling the Remote Controller" on page 50 for more information.
	Perhaps the batteries need replacing. See "Using the Remote Controller" on page 19 for more information.
The LOCK indicator flashes.	A flashing LOCK indicator indicates that the CDR1000 is not locked to the selected digital input source, in which case recording is not possible. See "Selecting the Input Source" on page 25 for more information.
Pressing and holding the [UTILITY] button does not cancel the Utility functions.	The [UTILITY] button must be pressed for two or more seconds in order to cancel a Utility functions.
Cannot monitor a signal connected to the ANALOG IN.	Make sure that the signal is connected to the ANALOG IN connector correctly and that the input source is set to ANALOG. Engage Record Standby mode and set the recording level using the REC LEVEL control.
The ANALOG IN signal level is too low or too high.	Set the ANALOG IN level switch to match the operating level of the connected equipment (–10 dBV or +4 dB), and set the recording level using the REC LEVEL control.
Cannot engage Record Standby mode.	Recording is not possible on finalized CD-R discs. Load another disc. See "Preparing to Record" on page 25 for more information.
Cannot increment the track number manually.	The track number cannot be incremented manually when Auto Rec/Track or Sync Recording is used. See "Incrementing Track Numbers Manually" on page 32 for more information.
Cannot increment the index number manually.	The index number cannot be incremented manually when Auto Rec/Track or Sync Recording is used. See "Incrementing Index Numbers Manually" on page 33 for more information.
Using the Auto Rec/Track function, the track number does not increment automatically.	If the space between tracks is very short, or the threshold is set too high, the track number may not increment properly. See "Using Auto Rec Start & Track Increment" on page 34 for more information.
Using the Auto Rec/Track function, the track number increments during quiet passages.	Try raising the threshold to see if that helps. Auto Rec/Track may not work very well with music that contains many silent passages. See "Using Auto Rec Start & Track Increment" on page 34 for more information.
Recording stops when using the Auto Rec/Track function.	If the level of the input signal is below the specified threshold for 20 or more seconds, recording stops automatically. See "Using Auto Rec Start & Track Increment" on page 34 for more information.
Cannot insert a mute.	Only one mute can be inserted at the beginning and end of each track. See "Inserting a Two-second Mute" on page 35 for more information.
	Rec Mute cannot be used with All-track Sync Recording. See "Inserting a Two-second Mute" on page 35 for more information.
Cannot apply a Fade In or Fade Out.	The Fade In and Fade Out parameters must be set before engaging Record Standby mode. Fade In and Fade Out cannot be used with Sync Recording. See "Applying a Fade In" on page 37 and "Applying a Fade Out" on page 38 for more information.

Symptom	Advice
<b>The SRC indicator lights up while recording.</b>	The SRC indicator lights up when the SRC (Sampling Rate Converter) is active. See “Setting the Sampling Rate Converter” on page 26 for more information.
<b>Sync Recording does not start automatically when recording from CD or MD.</b>	CD and MD players must be stopped or paused, as Sync Recording cannot be started while the source device is playing. See “Sync Recording from CD, MD, or DAT” on page 39 for more information.
<b>Using One-track Sync Recording, recording stops before the end of the track when recording from a DAT tape.</b>	Recording stops when the CDR1000 receives a Track Number, Start ID, or Skip ID. Make sure that there isn't a Skip ID in the middle of the track being recorded. See “Sync Recording from CD, MD, or DAT” on page 39 for more information.
<b>Using Sync Recording, the top of a track is cut off when recording from a DAT tape.</b>	Make sure that the DAT Start IDs are positioned slightly before the start of each track. See “Sync Recording from CD, MD, or DAT” on page 39 for more information.
<b>Sync Recording stops unexpectedly.</b>	If no input signal is received for 20 or more seconds, Sync Recording stops automatically. See “Sync Recording from CD, MD, or DAT” on page 39 for more information.

---

# Appendix

---

## Error Messages

If the CDR1000 displays an error message, follow the instructions below.

Error Number	Remarks
0XXXXX	1
1XXXXX	2
2XXXXX	
3XXXXX	
4XXXXX	
5XXXXX	

1. If the error cannot be fixed by opening or closing the disc tray, and the error remains even after powering off and on, contact your Yamaha dealer.
2. If the error remains even after powering off and on, contact your Yamaha dealer.

## Specifications

<b>Recording media</b>		CD-R, CD-RW
<b>Playback media</b>		CD, CD-R, CD-RW
<b>Sampling rate</b>		44.1 kHz
<b>Recording resolution</b>		16-bit linear
<b>Converters</b>	A/D	20-bit 64-times oversampling
	D/A	20-bit 128-times oversampling
<b>Frequency response</b>		20 Hz–20 kHz
<b>Track</b>		Up to 99 tracks
<b>Index</b>		Up to 99 indexes
<b>SRC (Sampling Rate Converter)</b>		30 kHz to 50 kHz
<b>16-bit encoding</b>		UV22
<b>S/N</b>		97 dB
<b>Input delay</b>		0–4,950 ms
<b>Fade in/out time</b>		0–10 second
<b>Synchronized recording</b>		CD, MD, DAT
<b>Repeat playback</b>		One track, All track, A–B
<b>Locate</b>		PREV, NEXT, INDEX, SEARCH, direct select
<b>Display</b>	<b>Type</b>	VFD (Vacuum Fluorescent Display)
	<b>Characters</b>	12-character line
	<b>Time counter</b>	Minutes and seconds
	<b>Display mode</b>	Elapse, Remain, Total
	<b>Track counter</b>	0–99
	<b>Index counter</b>	0–99
	<b>Level meters</b>	16 segment with CLIP indicator x2
<b>Power requirements</b>		U.S.A. & Canada 120 V AC, 60 Hz Europe 230 V AC, 50 Hz
<b>Power consumption</b>		33 W
<b>Dimensions (W × H × D)</b>		480 × 101 × 389 mm (18.9 × 4 × 15.3 inches)
<b>Weight</b>		8 kg (17.6 lbs)
<b>Free-air operating temperature range</b>		5° C to 35° C (41° F to 95° F)
<b>Relative humidity</b>		10%–95%
<b>Accessories</b>		Power cord, remote controller, batteries (size AA, R6, UM-3 x2), transportation pad, <i>Owner's Manual</i>
<b>Options</b>		Yamaha FC5 footswitch

## Analog Input

Connection	Impedance	Input Level	Max. Level	Connector
ANALOG IN <sup>1</sup>	20 k $\Omega$	-10 dBV/+4 dB <sup>2</sup>	+18 dB/+4 dB <sup>3</sup>	XLR-3-31 type (balanced) <sup>4</sup>

1. 20-bit 64-times oversampling A/D converter.
  2. Switchable.
  3. Nominal record level
  4. XLR-type connectors are balanced (pin 1 = ground, pin 2 = hot, pin 3 = cold).
- \* Where dB represents a specific voltage, 0 dB is referenced to 0.775 V rms.  
 \* For -10 dBV levels, 0 dBV is referenced to 0 dBV.

## Analog Output

Connection	Impedance	Output Level	Max. Level	Connector
ANALOG OUT <sup>1</sup>	150 $\Omega$ lines	+4 dB	+18 dB	XLR-3-32 type (balanced) <sup>2</sup>
PHONES	40 $\Omega$	7 mW	100 mW	Stereo phone jack (unbalanced) <sup>3</sup>

1. 20-bit 128-times oversampling D/A converter.
  2. XLR-type connectors are balanced (pin 1 = ground, pin 2 = hot, pin 3 = cold).
  3. PHONES stereo phone jack is unbalanced (tip = left, ring = right, sleeve = ground).
- \* Where dB represents a specific voltage, 0 dB is referenced to 0.775 V rms.

## Digital Audio Input

Connection	Format	Level/Impedance	Connector
AES/EBU IN	AES/EBU	110 $\Omega$	XLR-3-31 type
COAXIAL IN	IEC-60958 Consumer Use	0.5 V pp (75 $\Omega$ )	Phono

## Digital Audio Output

Connection	Format	Level/Impedance	Connector
AES/EBU OUT	AES/EBU	110 $\Omega$	XLR-3-32 type
COAXIAL OUT	IEC-60958 Consumer Use	0.5 V pp (75 $\Omega$ )	Phono

# Dimensions

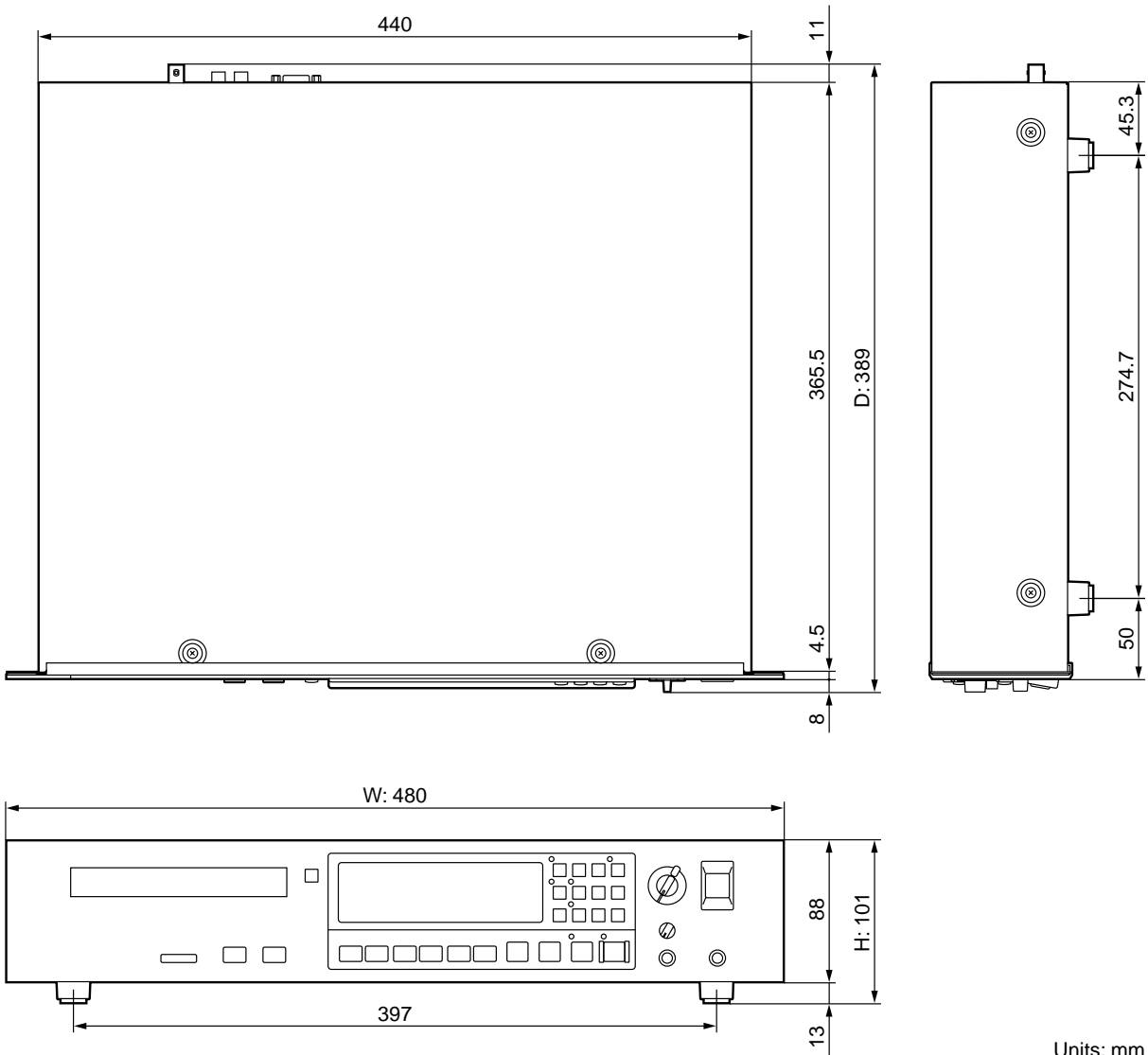

Units: mm

Specifications and external appearance subject to change without notice.

For European Model  
Purchaser/User Information specified in EN55103-1 and EN55103-2.  
Inrush Current: 3A  
Conformed Environment: E1, E2, E3 and E4

# Glossary

---

**CD-DA (Compact Disc Digital Audio)**—A digital storage medium that uses 120 mm optical discs to store 74 minutes of stereo 16-bit, 44.1 kHz digital audio.

**CD-R (Compact Disc Recordable)**—A recordable medium that cannot be rerecorded and is fixed for life.

**CD-RW (Compact Disc Rewritable)**—A recordable medium that can be rerecorded even after it has been finalized.

**Finalization**—The process of writing the final TOC, which allows discs to be played on standard players.

**OPC (Optimum Power Control)**—The test performed each time a CD-R or CD-RW disc is loaded into a CD recorder to determine the optimum laser power necessary for recording.

**Orange Book**—The official specification for CD-R and CD-RW discs.

**PMA (Program Memory Area)**—The area of a CD-R or CD-RW disc that's used to store the temporary table of contents.

**Red Book**—The official specification for audio CDs.

**TOC (Table of Contents)**—The TOC contains track and index numbers, track start and end times, and track length information, and is read each time a disc is loaded into a CD player.

**Wordclock**—A clock signal used to synchronize the data processing circuits of all devices in a digital audio system.



# Index

## A

- A-B button 10
- A-B repeat playback 24
- AC IN connector 11
- AES/EBU IN connector 12
- AES/EBU indicator 8
- AES/EBU OUT connector 12
- AES/EBU OUT wordclock setting 46
- All-track repeat playback 24
- All-track sync recording
  - about 39
  - using 42
- ANALOG IN connectors 11
- ANALOG IN level switch 11
- ANALOG indicator 8
- ANALOG OUT connectors 11
- Auto finalize
  - all-track sync recording 42
  - one-track sync recording 40
- Auto rec/track
  - AUTO button & indicator 10
  - using 34

## B

- Batteries, remote controller 19
- BLANK message 18
- Block diagram 14
- Buying discs 4

## C

- CD indicator 18
- CD-DA, definition 58
- CD-R
  - definition 58
  - finalizing 44
  - indicator 18
  - logo 4
- CDR1000
  - block diagram 14
  - dimensions 57
  - features 2
  - front panel 6
  - rear panel 11
  - specifications 55
  - turning on and off 16
- CD-RW
  - definition 58
  - erasing 45
  - finalizing 44
  - indicator 18
  - logo 4
- CHECK INPUT message 18
- CLOSE message 18

- COAX indicator 8
- COAXIAL IN connector 12
- COAXIAL OUT connector 12
- Coaxial, definition 58
- Connecting the power cord 16
- Copy bit, setting 28
- COPY indicators 8

## D

- DAT
  - definition 58
  - sync recording 39
- Delay, input 27
- Digital output thru 48
- Dimensions 57
- Direct track selection 23
- Disabling the remote controller 50
- Disc tray 6
- Discs
  - erasing 45
  - finalizing 44
  - loading 18
  - unloading 18
- Disk type indicator 8
- Display
  - about 8
  - message area 9
- Duplicating discs 48

## E

- ELAPSE indicator 8
- Emphasis
  - about 5
- ERASE button 6
- Erasing discs 45
- Error messages 54

## F

- Fade in, applying 37
- Fade out, applying 38
- Fan 11
- Features 2
- Finalization
  - about 5
  - definition 58
  - using 44
- FINALIZE button 6
- FOOT SW jack 7
- Footswitch operation 50
- Front panel 6

## H

- Hookup examples 15

## I

- Incrementing
  - index numbers manually 33
  - track numbers automatically 34
  - track numbers manually 32
- INDEX buttons 7
- INDEX counter 8
- INDEX INC button 10
- Index numbers
  - incrementing manually 33
  - sync recording 39
- Indexes
  - selecting 23
- Input delay, setting 27
- INPUT SELECT button 9
- Input source, selecting 25
- Inserting a mute 35
- Installation 1

## L

- Level meters
  - about 9
  - response rate 20
  - using 20
- Loading discs 18
- LOCK indicator 8

## M

- Mains lead 16
- Manually incrementing index numbers 33
- Manually incrementing track numbers 32
- MD
  - sync recording 39
- Message area, display 9
- Metering 20
- Meters
  - about 9
  - response rate 20
  - using 20
- Monitoring 20

## N

- NEXT button 7
- NO CD message 18
- NO DISC message 18
- Number keypad
  - about 13
  - using 23

**O**

- ONCE, copy bit 28
- One-track repeat playback 24
- One-track sync recording
  - about 39
  - using 40
- OPC
  - about 4
  - definition 58
  - OPC message 18
  - OPC OVER message 18
- OPEN message 18
- OPEN/CLOSE button 6
- Operating notes 4
- Orange Book, definition 58
- OUT OF RANGE message 18
- Owner's manual, about 1

**P**

- Parallel port
  - PARALLEL port 12
  - using 51
- PAUSE button 7
- PAUSE indicator 9
- Pausing playback 21
- Peak hold
  - PEAK HOLD button & indicator 9
  - using 20
- PERMIT, copy bit 28
- PHONES jack 7
- PHONES LEVEL control 7
- PLAY button & indicator 7
- PLAY indicator 8
- Playback
  - operation table 22
  - pausing 21
  - repeat playback 24
  - stopping 21
  - using 21
- PMA, definition 58
- Power cord 16
- POWER switch
  - about 6
  - using 16
- Powering up the CDR1000 16
- Preparing to record 25
- PREV button 7
- Preview 24
- PROTECT, copy bit 28
- Purchasing discs 4

**R**

- READING message 18
- Rear panel 11
- REC button & indicator 7
- REC indicator 9
- REC LEVEL control 6
- REC MUTE button & indicator 10
- Rec mute standby mode 35
- Record standby mode 29
- Recording
  - all-track sync recording 42
  - auto start 34
  - fade in 37
  - fade out 38
  - incrementing index numbers
    - manually 33
  - incrementing track numbers
    - automatically 34
    - manually 32
  - inserting a mute 35
  - one-track sync recording 40
  - operation table 31
  - preparing 25
  - recording 29
  - sync recording 39
- Red Book, definition 58
- REMAIN indicator 8
- Remote controller
  - about 13
  - direct track selection 23
  - disabling 50
  - installing batteries 19
  - sensor window 6
  - using 19
- REPEAT button 10
- REPEAT indicators 9
- Repeat playback 24
- Response rate, level meters 20
- Review 24
- ROM message 18

**S**

- Sampling rate converter, setting 26
- SEARCH buttons 7
- Searching 24
- Selecting
  - direct track selection 23
  - discs 4
  - indexes 23
  - input source 25
  - tracks 23
- SELF-CHECK message 18
- Skip ID and sync recording 39
- Specifications 55
- SRC indicator 8
- Start ID and sync recording 39

- STOP button 7
- Stopping
  - playback 21
  - recording 29
- Super CD encoding 28
- Switching on the CDR1000 16
- SYNC REC button 10
- Sync recording
  - about 39
  - all-track sync recording 42
  - one-track sync recording 40
- SYNC-REC indicators 9

**T**

- Thru, digital outputs 48
- Time counter 8
- Time display
  - TIME DISPLAY button 9
  - using 19
- TOC, definition 58
- TOTAL indicator 8
- TRACK counter 8
- TRACK INC button 10
- Track numbers
  - incrementing automatically 34
  - incrementing manually 32
  - with sync recording 39
- Tracks
  - direct selection 23
  - selecting 23
- Transportation pad 17
- Troubleshooting 52
- Turning on the CDR1000 16

**U**

- Unloading discs 18
- UNRECORDABLE message 18
- UTILITY button & indicator 10
- UV22 28
- UV22 button & indicator 10

**W**

- WAIT message 18
- WORD CLOCK IN connector 12
- Wordclocks
  - AES/EBU OUT 46
  - definition 58

