

ARRAY FRAME VAF2-2112(W) Owner's Manual

EN

*Thank you for choosing this Yamaha product.
Please read this manual carefully before using it in a speaker installation.
Keep the manual in safe place for future reference.*

Package Contents

VAF2-2112(W)

- 3-1101 Angle indicator plate (4 pcs.)
- 3-0235 M10-40mm button head socket screws (8 pcs.)
- 2-1432 M10 flat washers (11 pcs.)
- 3-0112 M10 L-key wrench (1 pc.)

- NOTE**
- Use only the eye bolts included with the speaker unit.
 - For information on load limits and the strength of the eyebolt, refer to the owner's manual of the speaker.

Installation Instructions

1. Determine the splay of the speakers and the holes to use for the splay angle. Remove the speaker screws.
2. Set the speakers so the tops are facing up. Attach an angle indicator plate on the rear insert of the speaker using the slots of the plate with the provided screws and washers. Attach another angle indicator plate on the top front insert using the corresponding holes for the appropriate splay angle with the provided screws and washers. Tighten permanently.
3. Carefully flip the speakers up side down so the bottoms are facing up.
4. Repeat step 2 for installing the other two angle indicator plates.
5. Flip the speaker on its side and install two M10 eye bolts on the side of the speaker.
6. Use the eye bolts to suspend the speaker cluster assembly.

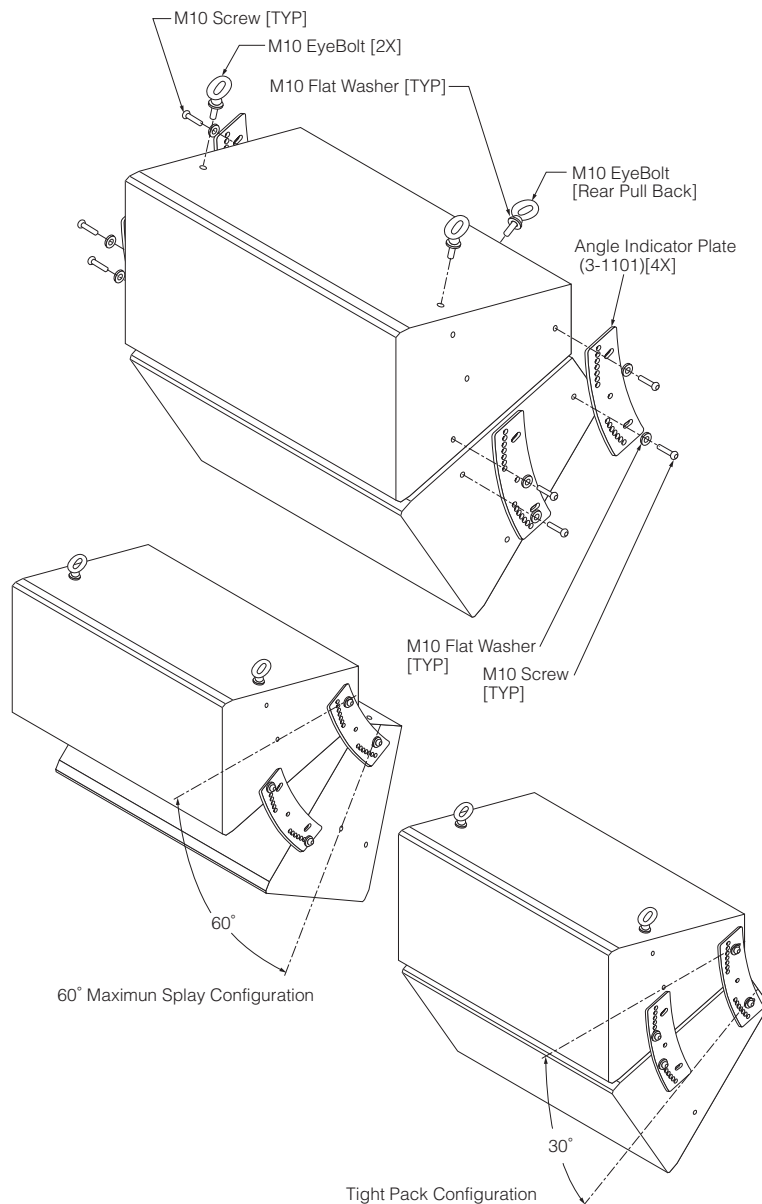

PRECAUTIONS

PLEASE READ CAREFULLY BEFORE PROCEEDING

* Please keep this manual in a safe place for future reference.

CAUTION

Always follow the basic precautions listed below to avoid the possibility of physical injury to you or others, or damage to the device or other property. These precautions include, but are not limited to, the following:



- Before doing any installation or construction work, consult with an installation expert.
- Make sure that the surface this bracket is being mounted on has the strength to handle the weight of both the speaker and this bracket.
- Use bolts and nuts as well as washers for installation and tighten them firmly so that the speaker is secure and does not move.
- Always loosen the corresponding screw before adjusting the angle or direction of the speaker. Never force this adjustment with the screw still tightened.
- Some fittings may deteriorate over extended periods of time due to wear and/or corrosion. For optimum safety, the installation should be checked thoroughly at regular intervals.

Yamaha cannot be held responsible for damage or injury caused by insufficient strength of the support structure or improper installation.

* Illustrations herein are for explanatory purposes only, and may not match actual appearance during operation.

* Company names and product names herein are trademarks or registered trademarks of their respective companies.

* Specifications and descriptions in this owner's manual are for information purposes only. Yamaha Corp. reserves the right to change or modify products or specifications at any time without prior notice. Since specifications, equipment or options may not be the same in every locale, please check with your Yamaha dealer.

Dimensions

3-1101 Angle Indicator Plate

