

YAMAHA CDC-835

Natural Sound Compact Disc Player

5-Disc Carousel Auto-changer

PLAYXCHANGE; Disc changing capability while playing another

Random Access Programmable Play

Random-Sequence Play

Single Track/Entire Disc/All Disc Repeat Play

Program Data Filing Capability

5-Mode Digital Equalizer

10-Disc Relay Play by Connecting Two CDC-835s

Display Brightness Changing Capability

Concealed Control Panel

Remote Control Capability

Thank you for selecting this YAMAHA compact disc player.



OWNER'S MANUAL

CONTENTS

Safety Instructions.....	2
Connections	4
Identification of Components.....	5
Loading the Disc/Disc Play.....	6
Random-Sequence Play	11
Program Play.....	12
Repeat Play	16
Index Search	16
Track Programming for Recording to Tape.....	17
Relay Play	20
Notes about the Remote Control Transmitter.....	22
Notes about Handling Compact Discs...	22
Troubleshooting.....	23
Specifications	23

IMPORTANT!

Please record the serial number of this unit in the space below.

Model:
Serial No.:

The serial number is located on the rear of the unit.
Retain this Owner's Manual in a safe place for future reference.

WARNING

TO REDUCE THE RISK OF FIRE OR ELECTRIC SHOCK, DO NOT EXPOSE THIS UNIT TO RAIN OR MOISTURE.

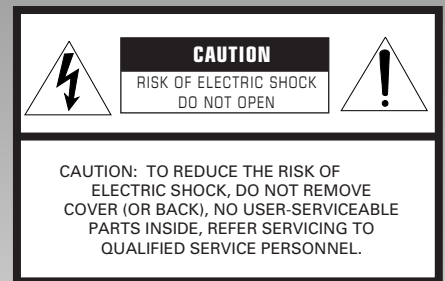

• Explanation of Graphical Symbols



The lightning flash with arrowhead symbol, within an equilateral triangle, is intended to alert you to the presence of uninsulated "dangerous voltage" within the product's enclosure that may be of sufficient magnitude to constitute a risk of electric shock to persons.



The exclamation point within an equilateral triangle is intended to alert you to the presence of important operating and maintenance (servicing) instructions in the literature accompanying the appliance.

SAFETY INSTRUCTIONS

- 1 Read Instructions – All the safety and operating instructions should be read before the unit is operated.
- 2 Retain Instructions – The safety and operating instructions should be retained for future reference.
- 3 Heed Warnings – All warnings on the unit and in the operating instructions should be adhered to.
- 4 Follow Instructions – All operating and other instructions should be followed.
- 5 Water and Moisture – The unit should not be used near water – for example, near a bathtub, washbowl, kitchen sink, laundry tub, in a wet basement, or near a swimming pool, etc.
- 6 Carts and Stands – The unit should be used only with a cart or stand that is recommended by the manufacturer.
- 6A A unit and cart combination should be moved with care. Quick stops, excessive force, and uneven surfaces may cause the unit and cart combination to overturn. 
- 7 Wall or Ceiling Mounting – The unit should be mounted to a wall or ceiling only as recommended by the manufacturer.
- 8 Ventilation – The unit should be situated so that its location or position does not interfere with its proper ventilation. For example, the unit should not be situated on a bed, sofa, rug, or similar surface, that may block the ventilation openings; or placed in a built-in installation, such as a bookcase or cabinet that may impede the flow of air through the ventilation openings.
- 9 Heat – The unit should be situated away from heat sources such as radiators, stoves, or other appliances that produce heat.
- 10 Power Sources – The unit should be connected to a power supply only of the type described in the operating instructions or as marked on the unit.
- 11 Power-Cord Protection – Power-supply cords should be routed so that they are not likely to be walked on or pinched by items placed upon or against them, paying particular attention to cords at plugs, convenience receptacles, and the point where they exit from the unit.
- 12 Cleaning – The unit should be cleaned only as recommended by the manufacturer.
- 13 Nonuse Periods – The power cord of the unit should be unplugged from the outlet when left unused for a long period of time.
- 14 Object and Liquid Entry – Care should be taken so that objects do not fall into and liquids are not spilled into the inside of the unit.
- 15 Damage Requiring Service – The unit should be serviced by qualified service personnel when:
 - A. The power-supply cord or the plug has been damaged; or
 - B. Objects have fallen, or liquid has been spilled into the unit; or
 - C. The unit has been exposed to rain; or
 - D. The unit does not appear to operate normally or exhibits a marked change in performance; or
 - E. The unit has been dropped, or the cabinet damaged.
- 16 Servicing – The user should not attempt to service the unit beyond those means described in the operating instructions. All other servicing should be referred to qualified service personnel.
- 17 Power Lines – An outdoor antenna should be located away from power lines.
- 18 Grounding or Polarization – Precautions should be taken so that the grounding or polarization is not defeated.

CAUTION: READ THIS BEFORE OPERATING YOUR UNIT

- 1 To ensure the finest performance, please read this manual carefully. Keep it in a safe place for future reference.
- 7 Be sure to read the “TROUBLESHOOTING” section on common operating errors before concluding that your unit is faulty.

- 2 Install your unit in a cool, dry, clean place – away from windows, heat sources, and too much vibration, dust, moisture or cold. Avoid sources of hum (transformers, motors). To prevent fire or electrical shock, do not expose to rain and water.
- 3 Do not operate the unit upside-down. It may overheat, possibly causing damage.
- 4 Never open the cabinet. If a foreign object drops into the set, contact your dealer.
- 5 Do not use force on switches, knobs or cords. When moving the set, first turn the unit off. Then gently disconnect the power plug and the cords connecting to other equipment. Never pull the cord itself.
- 6 Do not attempt to clean the unit with chemical solvents; this might damage the finish. Use a clean, dry cloth.

CAUTION FOR CARRYING THIS UNIT

Be sure not to carry or tip the unit with discs remaining in it.

CAUTION FOR MOVING THIS UNIT

When moving this unit, first remove all discs from the disc tray and close the tray by pressing the **OPEN/CLOSE** button, and then switch off the power after you confirm that the display has turned as follows.



Never switch off the power if the display does not turn as above, otherwise the unit will get out of order during moving because the internal mechanism is not locked.

WARNING

CAUTION

Use of controls or adjustments or performance of procedures other than those specified herein may result in hazardous radiation exposure.

DANGER

Invisible laser radiation when open and interlock failed or defeated.
Avoid direct exposure to beam.

As the laser beam used in this compact disc player is harmful to the eyes, do not attempt to disassemble the cabinet. Refer servicing to qualified personnel only.

To avoid electrical shock, do not open the unit. Refer servicing to qualified personnel only.

DANGER: The use of optical instrument with this product will increase eye hazard.

The apparatus is not disconnected from the AC power source as long as it is connected to the wall outlet, even if the apparatus itself is turned off.

FCC INFORMATION

1. IMPORTANT NOTICE : DO NOT MODIFY THIS UNIT!

This product, when installed as indicated in the instructions contained in this manual, meets FCC requirements. Modifications not expressly approved by Yamaha may void your authority, granted by the FCC, to use the product.

2. IMPORTANT : When connecting this product to accessories and/or another product use only high quality shielded cables. Cable/s supplied with this product **MUST** be used. Follow all installation instructions. Failure to follow instructions could void your FCC authorization to use this product in the USA.

3. NOTE : This product has been tested and found to comply with the requirements listed in FCC Regulations, Part 15 for Class "B" digital devices. Compliance with these requirements provides a reasonable level of assurance that your use of this product in a residential environment will not result in harmful interference with other electronic devices.

This equipment generates/uses radio frequencies and, if not installed and used according to the instructions found in the users manual, may cause interference harmful to the operation of other electronic devices. Compliance with FCC regulations does not guarantee that interference will not occur in all installations. If this product is found to be the source of interference, which can be determined by turning the unit "OFF" and "ON", please try to eliminate the problem by using one of the following measures:

Relocate either this product or the device that is being affected by the interference.

Utilize power outlets that are on different branch (circuit breaker or fuse) circuits or install AC line filter/s.

In the case of radio or TV interference, relocate/reorient the antenna. If the antenna lead-in is 300 ohm ribbon lead, change the lead-in to coaxial type cable.

If these corrective measures do not produce satisfactory results, please contact the local retailer authorized to distribute this type of product. If you can not locate the appropriate retailer, please contact Yamaha Electronics Corp., U.S.A. 6660 Orangethorpe Ave, Buena Park, CA 90620.

The above statements apply **ONLY** to those products distributed by Yamaha Corporation of America or its subsidiaries.

We Want You Listening For A Lifetime

YAMAHA and the Electronic Industries Association's Consumer Electronics Group want you to get the most out of your equipment by playing it at a safe level. One that lets the sound come through loud and clear without annoying blaring or distortion – and, most importantly, without affecting your sensitive hearing. Since hearing damage from loud sounds is often undetectable until it is too late, YAMAHA and the Electronic Industries Association's Consumer Electronics Group recommend you to avoid prolonged exposure from excessive volume levels.



CONNECTIONS

- Before making any connections, switch OFF the power to the unit and the amplifier or other component.
- Connections should be made to the correct input terminals of the amplifier or other component.
- If the placement of this unit causes noise to other equipment, such as a tuner, separate them from each other.

- If you use the DIGITAL OUTPUT (COAXIAL) terminal for the connection, be sure to set the DIGITAL OUT ON/OFF switch on the rear of this unit to the "ON" position. Otherwise, this switch should be set to the "OFF" position.

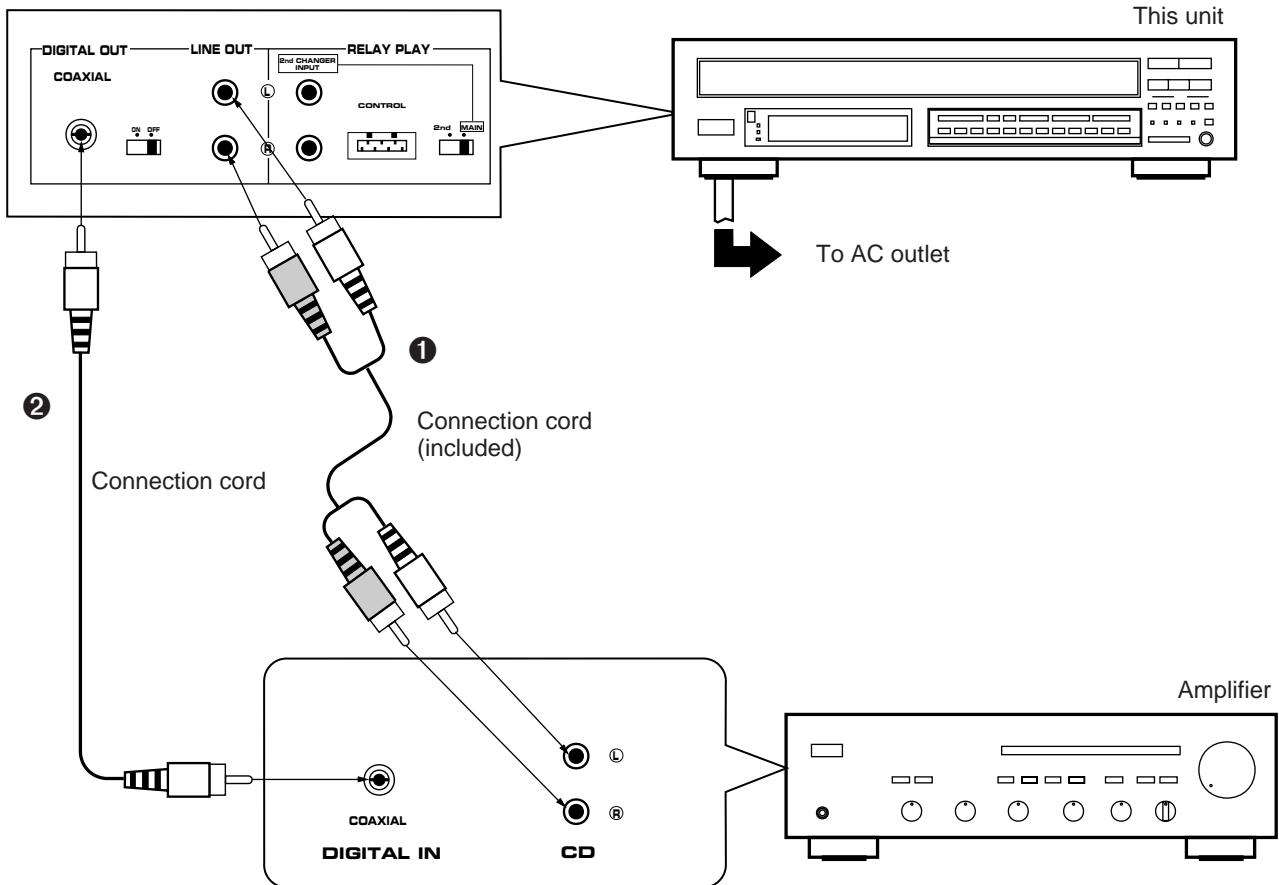

Choose one of the ways listed below to connect this unit to your amplifier.

When the LINE OUT (analog) terminals of this unit are used (①)

- Be sure to set the DIGITAL OUT ON/OFF switch on the rear of this unit to the "OFF" position.
 - Be sure that the left ("L") and right ("R") LINE OUT terminals are connected to the corresponding (left and right) terminals of the amplifier or other component.
 - Connect the "LINE OUT" terminals to the "CD" (or "AUX") terminals of the amplifier. If the amplifier does not have such terminals, use the "TAPE PB" terminals. For additional details concerning these connections, refer to the operation instructions for the amplifier being used.
 - Adjust the level of signals output into an amplifier, etc. by using the **OUTPUT LEVEL** control.
- * Switching the DIGITAL OUT ON/OFF switch on the rear panel resets the adjusted LINE OUT (analog) output level to maximum.

When the DIGITAL OUT (COAXIAL) terminal of this unit is used (②)

- Be sure to set the DIGITAL OUT ON/OFF switch on the rear of this unit to the "ON" position.
- Make the connection from this terminal to the digital input terminal of an amplifier or D/A (digital-to-analog) converter by using a connection cord.
- The level of signals output into an amplifier is fixed to max. and cannot be adjusted.

IDENTIFICATION OF COMPONENTS

FRONT PANEL

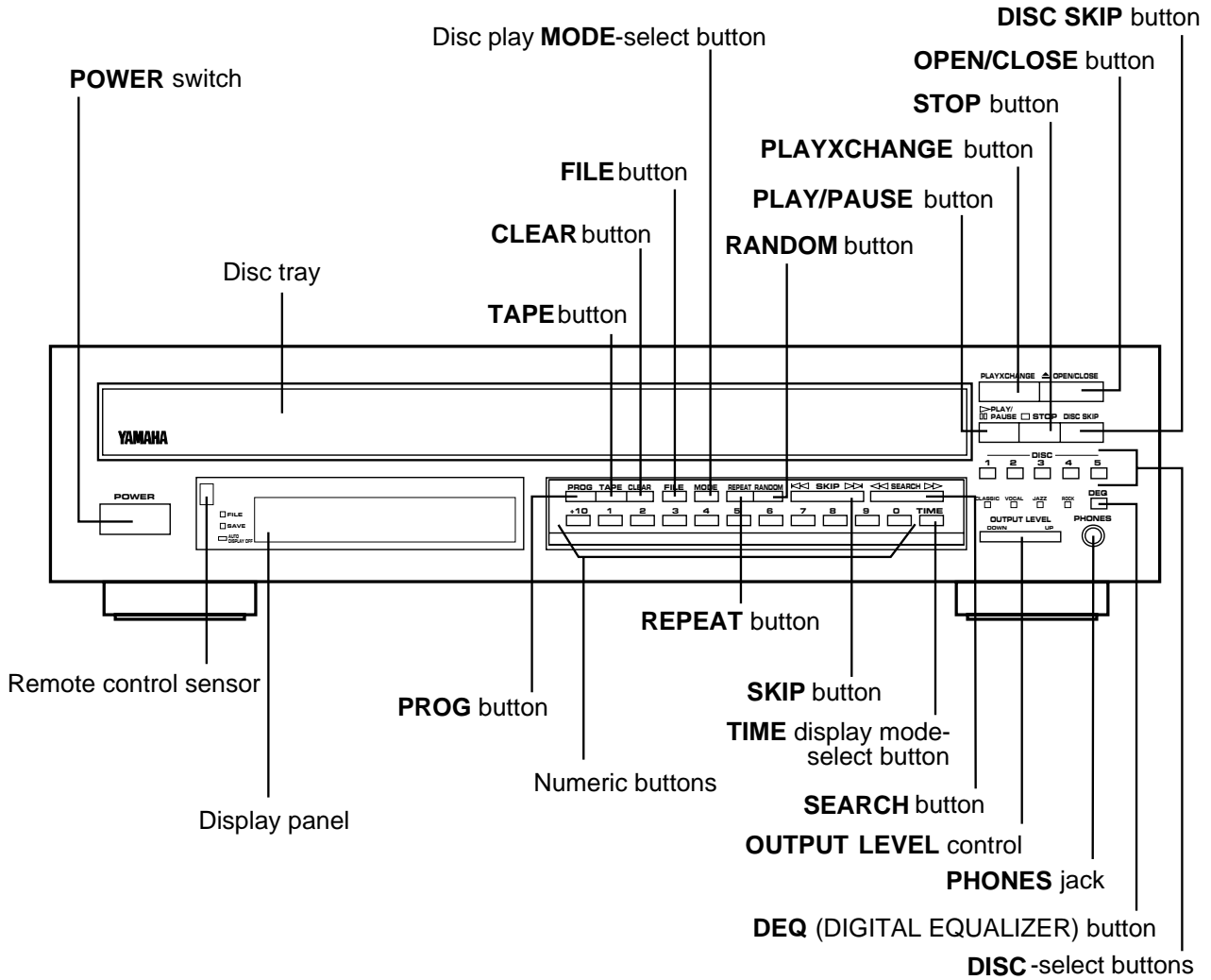

REMOTE CONTROL TRANSMITTER

The control functions on the main unit and on the remote control transmitter are virtually identical, with the exceptions described below.

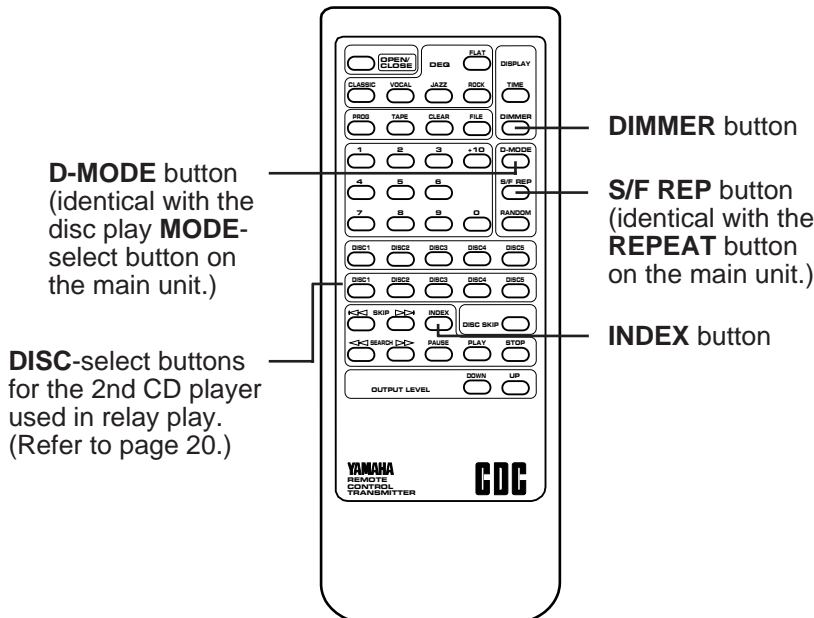

- * The **PLAY/PAUSE** button on the main unit has both the functions of the **PLAY** button and the **PAUSE** button on the remote control transmitter.
- * The **DEQ** (DIGITAL EQUALIZER) button on the main unit is divided into five buttons with individual functions on the remote control transmitter. (Refer to page 8.)

LOADING THE DISC/DISC PLAY

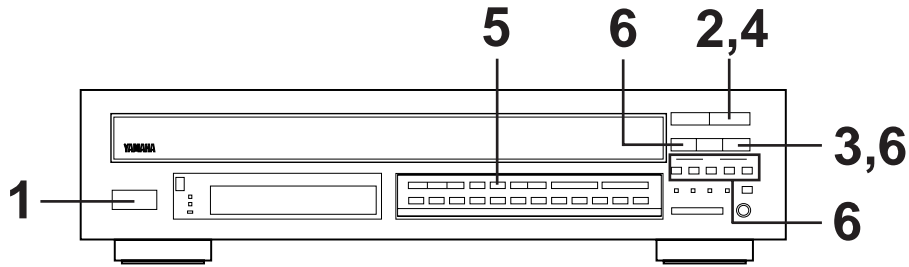

1 POWER

2 Label side upward

Disc tray

3 DISC SKIP

4 OPEN/CLOSE

5 Select the disc play mode (DISC MODE: SINGLE or ALL) while watching the display.

MODE

DISC MODE SINGLE ALL

Shows the selected disc mode.

“SINGLE” mode: The unit will play a designated disc only.
 “ALL” mode: The unit will play all discs in the tray in sequence.

6 PLAY/PAUSE

* If necessary, select a desired disc by using a DISC-select button or the DISC SKIP button.

DISC SKIP

1 2 DISC 3 4 5

PLAY/PAUSE

Notes

- After closing the disc tray by pressing the **OPEN/CLOSE** button in the stop mode or after selecting any disc by using the **DISC SKIP** button, the display shows the total number of tracks and the total recorded time of the disc to be played for a few seconds.

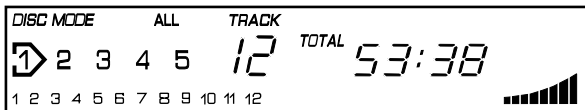

- Additionally, you can close the disc tray by pressing the **PLAY/PAUSE** button, a **DISC-select** button, a numeric button or the **RANDOM** button, or by pressing the front edge of the disc tray gently. If the tray is closed in these ways, play will begin automatically, however, the display will not show the total number of tracks and the total recorded time of the first disc to be played.

PLAYXCHANGE

During play, you can open the disc tray by pressing the **PLAYXCHANGE** button without interrupting disc play. However, in this case, pressing the **DISC SKIP** button has no effect.

To stop play temporarily

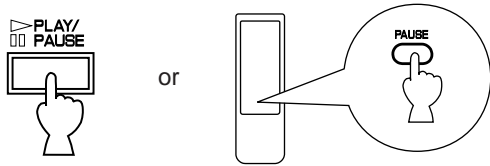

To stop play completely

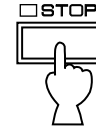

* To resume play, press the **PLAY/PAUSE** button again (or press the **PLAY** or **PAUSE** button on the remote control transmitter).

To play a desired track on the disc

DIRECT PLAY

Select a desired track by using the numeric buttons.

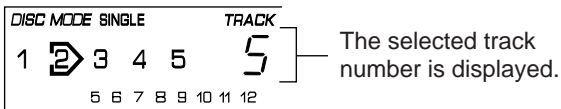
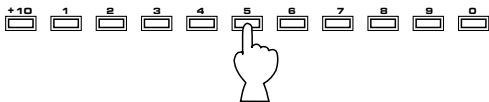

Example: To select track 25
Press ① twice, then immediately press ② once.

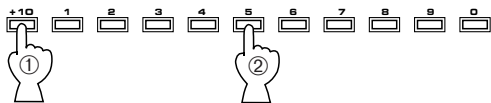

* If a track number higher than the highest track number on the disc is selected, the last track on the disc will be played.

SKIP PLAY

- To play from the beginning of the track following the one now playing

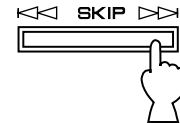

- To play from the beginning of the track now playing

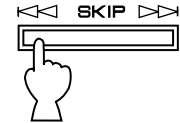

- To play from the beginning of the track before the one now playing

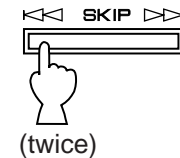

* These operations can also be performed when the unit is in the pause or stop mode.

Display information at disc play

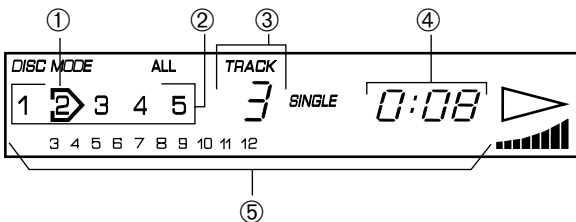

- Encloses the tray number of the disc standing by to be played or the disc now playing.
- Shows the tray numbers with discs.
- Shows the track number to be played.
- Shows the time displays. (Refer to "Selecting time displays" on page 9.)
- Displays the numbers that correspond to the numbers of the tracks (as high as number 20) on the disc. After each track is played, its corresponding number disappears so the number of remaining tracks (and their numbers) can be seen at a glance.

To advance or reverse play rapidly (MANUAL SEARCH)

To advance rapidly

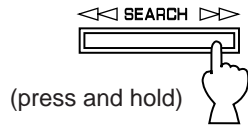

- The sound can be heard (although slightly garbled) during manual search in either direction. This is convenient for locating a precise position within a track, or for reviewing the contents quickly.
- Manual search can also be performed while disc play is paused, though no sound will be heard.

To reverse rapidly

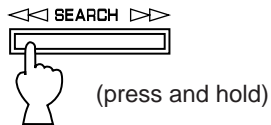

Using the built-in DIGITAL EQUALIZER (DEQ)

If desired, select any DEQ-mode suitable for the source sound.

On the front panel

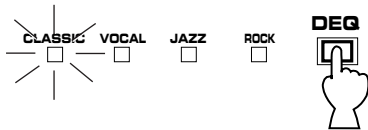

Pressing the **DEQ** button will switch the mode in turn. The indicator for the selected mode will illuminate. [No illumination shows that the DIGITAL EQUALIZER is turned off (FLAT).]

On the remote control transmitter

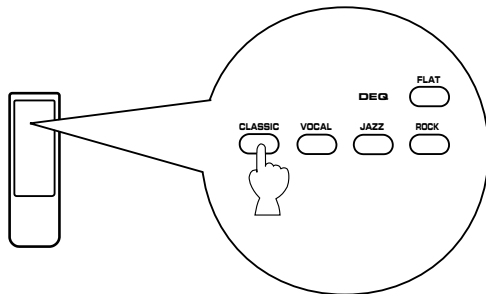

Press any desired DEQ-mode select button.

CLASSIC	More expanded sound is gained. It is suitable for listening to classic music, etc.
VOCAL	Vocal part of the source sound is emphasized.
JAZZ	You can enjoy acoustic image of the source sound with much presence.
ROCK	Low range and high range of the source sound are somewhat emphasized. It is suitable for listening to rock or pop music.
FLAT	The source sound is played back without any DIGITAL EQUALIZER effect.

Selecting time displays

You can select any of the four time displays by pressing the **TIME** display mode-select button.

① Elapsed time of the track now playing

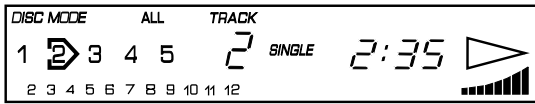

④ Total remaining time on the disc

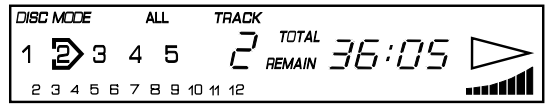

② Remaining time of the track now playing

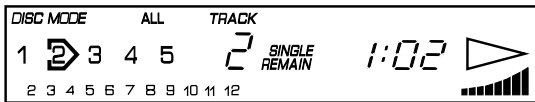

③ Total disc play time

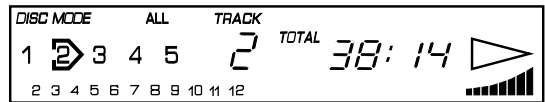

Note

The remaining time ② will not be displayed for track number 21 or higher.

Changing brightness of the display

You can change the brightness of the display (or turn off the illumination) by pressing the **DIMMER** button.

During play

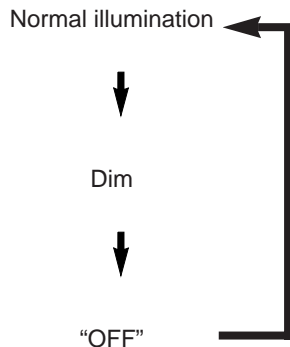

Except during play

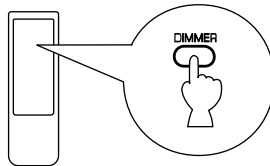
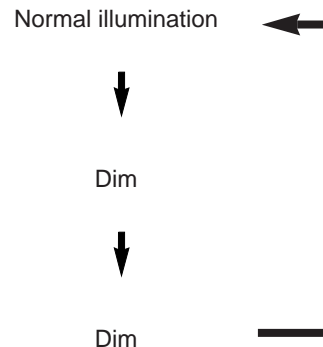

(The **AUTO DISPLAY OFF** indicator illuminates. In this mode, if a disc is played, the display illumination will be off.)

* While the display illumination is off, the **AUTO DISPLAY OFF** indicator on the front panel illuminates.

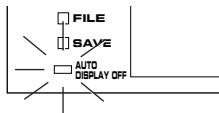

When you listen with headphones

Connect the headphones to the **PHONES** jack and adjust the volume by using the **OUTPUT LEVEL** control.

- * Note that the use of the **OUTPUT LEVEL** control will also vary the level of the signal output to the amplifier.
- * If the **DIGITAL OUT (COAXIAL)** terminal on the rear of this unit is used for the connection to the amplifier, the **PHONES** jack cannot be used.

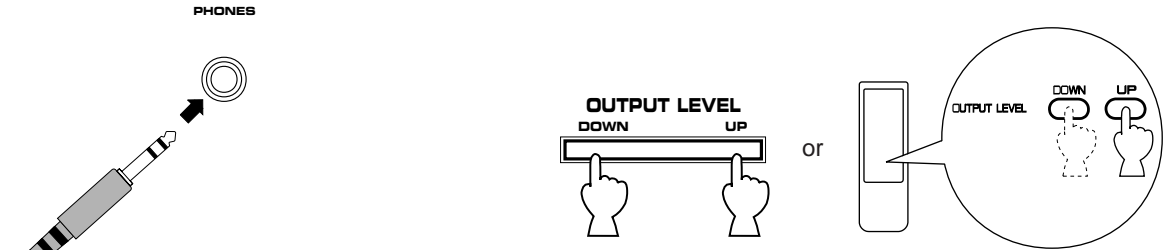

Open/close the control door

When it is not necessary to operate controls inside the control door, close the door.

To close the door

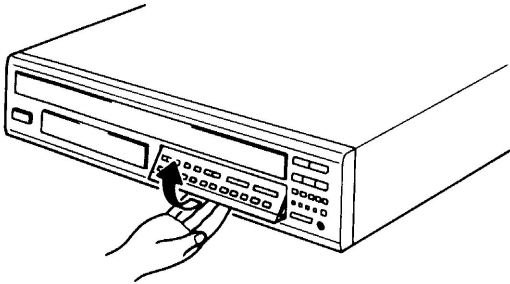

To open the door

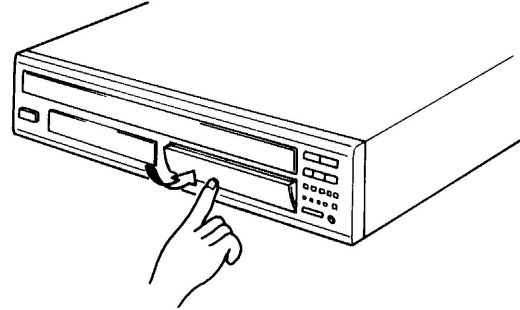

RANDOM-SEQUENCE PLAY

You can play the tracks in a random sequence (up to 99 tracks). The unit will automatically mix up tracks from all discs or any desired disc in the disc tray.

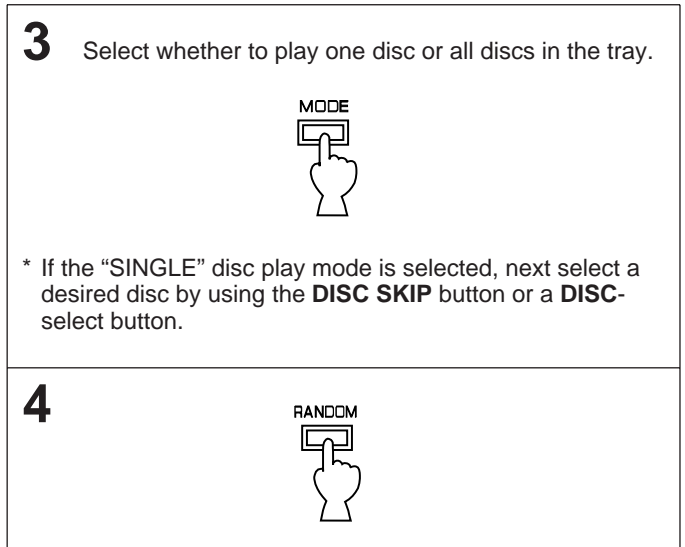
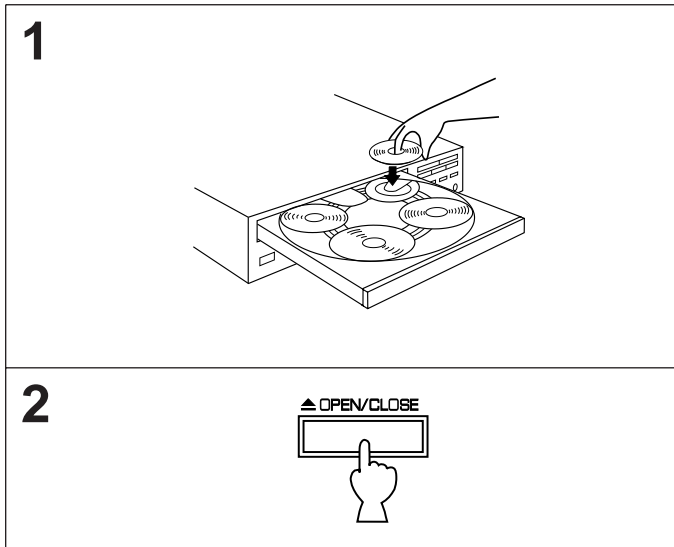
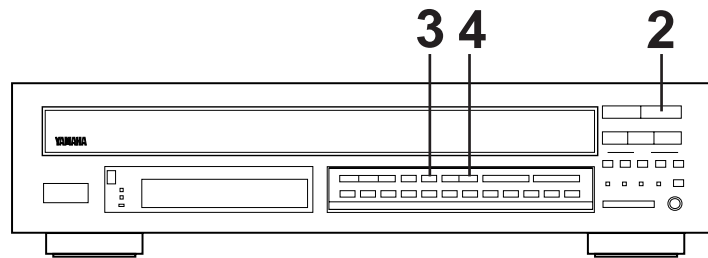

To cancel random-sequence play

Press the **STOP** button or **RANDOM** button once again, or open the disc tray by pressing the **OPEN/CLOSE** button.

Notes

- This feature will not function during programming, or during programmed play.
- If the **POWER** is switched off when the random-sequence play mode is functioning, when the **POWER** is switched on again, the unit will begin the random-sequence play automatically. (This feature is available for timer play.)
- If the **SKIP** \gg button is pressed during random-sequence play, the next randomly programmed track will be played. If the **SKIP** \ll button is pressed, play will return to the beginning of the track now being played.
-  This indication appears while the unit is mixing up tracks.
- Total remaining time on the disc will not be displayed during random-sequence play.

PROGRAM PLAY

You can enjoy listening to your favorite tracks selected from one or several discs in any desired order using programmed play.

* In addition, the DEQ (DIGITAL EQUALIZER)-mode selected for each track selection can be also programmed.

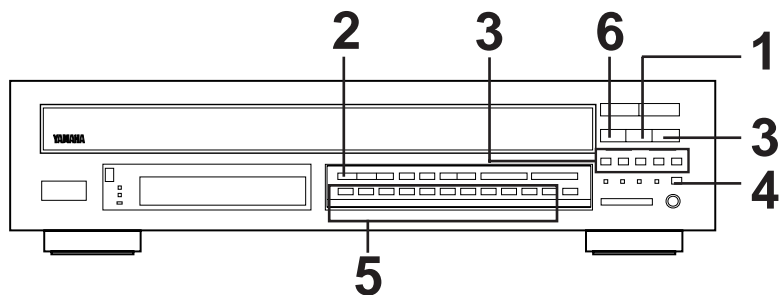

1 Stop the unit.

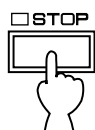

2



3 If necessary, select the desired disc.



or

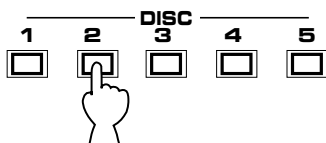

4 If necessary, select any desired DEQ-mode.



5 Select the desired track.

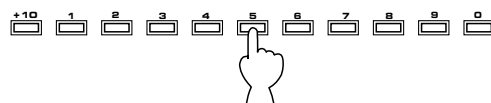

* Repeat step 3 – 5 to set more programs.

6 When the programming is completed;

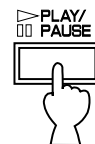

Display information during programming

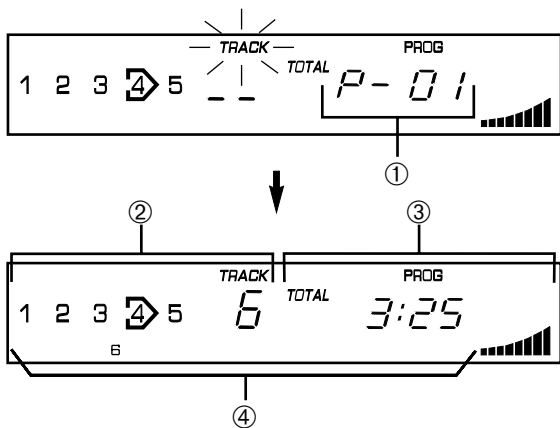

- ① Shows the program number for the track to be set next.
- ② Shows the selected disc and track number.
- ③ Shows the total time of the tracks currently programmed.
- ④ Shows only the numbers of programmed tracks on the selected disc.

* If "P-01" does not appear in the display after the **PROG** button is pressed, press the **TIME** display mode-select button.

* If the total time exceeds 99 minutes and 59 seconds, the time will not be displayed.

Notes

- You can set as many as 40 programs at one time.
- You can set a whole disc as a program by pressing "0", instead of selecting a track number. At that time, "AL" flashes in the display.
- If you will make programming with the DISC 1 tray empty, be sure to press the **DISC SKIP** button before starting programming.
- If you will program tracks from more than one disc, before you press the **PROG** button, check the total recorded time of each disc on the disc tray by pressing the **DISC SKIP** button in turn. Without this operation, the total time of the programmed tracks will not be displayed during programming.
- The total time of the programmed tracks will not be displayed, if a track number higher than 20 is programmed.
- If, during programming, the **TIME** display mode-select button is pressed, the program number display can be changed to display the total time of the programmed tracks or no information. To return to the previous display, press the **TIME** display mode-select button once again.
- The **SKIP** (**◀◀** and **▶▶**) button can be used during playing, but only within the range of the programmed tracks.
- The **SEARCH** (**◀◀** and **▶▶**) button can be used during playing to search through all tracks, including unprogrammed tracks.

To stop program play

- Press the **STOP** button. The first track number programmed will be displayed.
- To resume play, press the **PLAY/PAUSE** button. Play will begin from the beginning of the program.

To cancel a programmed setting

There are several methods, as described below.

- Press the **CLEAR** button while the unit is stopped.
- Press the **STOP** button while the unit is stopped.
- Open the disc tray.
- Switch off the power.

To check programmed data

1. If the unit is in the play mode, press the **STOP** button.
2. Press the **PROG** button.
3. Each time the **SKIP ▶▶** button is pressed, the track numbers and sequential order of the programmed tracks can be checked one after another. The display of the track number can be returned (sequentially in reverse order) by pressing the **SKIP ◀◀** button.

To correct programmed data

1. Follow the procedure described in "To check programmed data".
2. Display the track number to be corrected by pressing the **SKIP** button.
3. Press a numeric button to select a track to replace the one displayed. The previously programmed track will be cleared from the memory and the new one will be programmed.
4. After the correction has been completed, press the **PROG** button or **PLAY/PAUSE** button once again.

PROGRAM FILING

This unit has a function that can store (file) program data that has been set. You can play a disc with your favorite program at any time without setting it again. However, note that you can not file program data which consists of tracks selected from more than one disc.

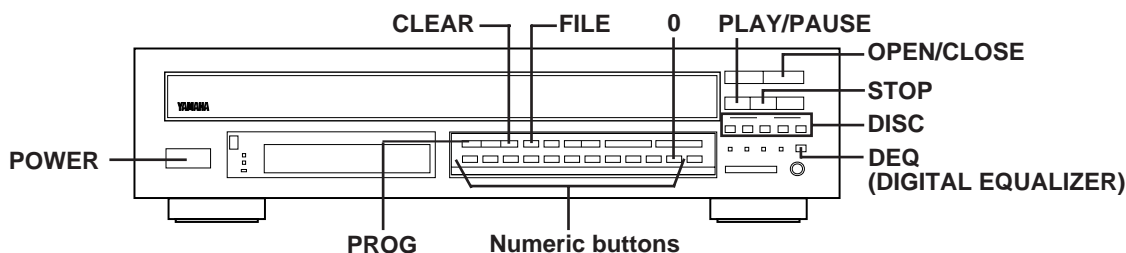

To file data of tracks programmed in a desired order

1. Follow step 1, 2, 3 and 4 on page 12.
(In step 4, turn the DEQ off (FLAT).)
2. Select track numbers in a desired order (by pressing numeric buttons).
3. Press the **FILE** button.

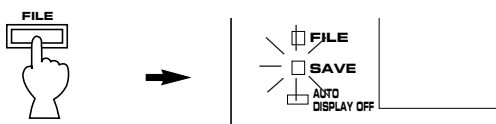

* If programs have already been set, make sure that "TRACK" is flashing continuously in the display. If it is not, once again press the **PROG** button. (If a program play is being performed, press the **STOP** button, and then press the **PROG** button.) Next, after setting the DEQ off (FLAT), press the **FILE** button.

Filing of a DEQ (DIGITAL EQUALIZER)-mode unique for a disc

Only one type of the DEQ-mode can be filed for any one disc. By this function, you can play a disc with the filed DEQ-mode at any time without re-setting it.

• To file data of tracks programmed in a desired order with DEQ-mode

1. Follow step 1, 2, 3 and 4 on page 12.
2. Select track numbers in a desired order (by pressing numeric buttons).
3. Press the **FILE** button.

• To file DEQ-mode for a disc (without track programming)

1. If the unit is playing a disc, press the **STOP** button.
2. If the unit is in a program play mode, press the **STOP** button or the **CLEAR** button to cancel it.
3. Select the desired disc by pressing the **SKIP** button.
4. Select a desired DEQ-mode. (The indicator for the mode will flash on and off for about 3 seconds. However, if the DEQ is turned off (FLAT), all indicators will flash.)
5. Press the **FILE** button while the indicator is flashing. (If the indicator stops flashing before you press the **FILE** button, follow step 4 again.)



* If this procedure is done to a disc for which program data has already been filed, the data of DEQ-mode will be replaced with the new one, however, the data of track programming will not be cleared.

Notes

- Program data filed in this way can be retained for about two weeks with the power switched off.
- One-program data can be filed for any one disc. If different program data is filed for a disc, the previous program data will be deleted from the file, and only the new program data will be retained in the file.

- Program data for a total of as many as about 100 discs can be filed at any one time.

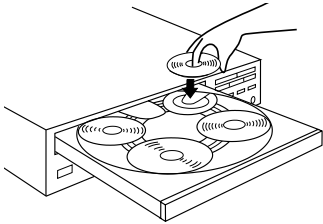
To play with program data

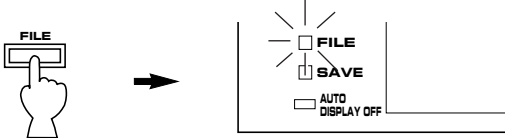
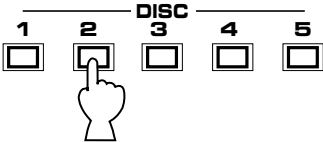
- 1 
- 2 
- 3 If the FILE indicator is not illuminated in the display, press the **FILE** button. 
- 4 Select the disc to be played. 

Notes

- If, in step 4, the SAVE indicator does not illuminate, the disc does not have its program data in the memory's file.
- To stop the play of the filed program data and change to ordinary play of the disc, press the **FILE** button. By this operation, the disc will be played in the ordinary sequence of tracks, but the program data in the memory's file for that disc will not be deleted from the memory. To once again call out the program data, follow step 3 and 4.
- In the "ALL" disc play mode, discs which have program data in the memory's file are played with their program data, and others are played normally.

To delete program data from file

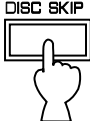
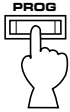
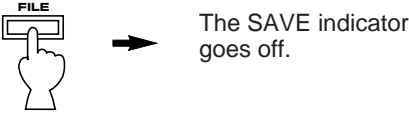
- 1 If the unit is playing a disc, press the **STOP** button.
* If a program play is on standby, press the **STOP** button or the **CLEAR** button to cancel that program setting.
- 2 If the FILE indicator is illuminated in the display, press the **FILE** button to turn the indicator off.
- 3 Select the disc of which program you want to delete. 
- 4 
- 5 

To delete all program data from the memory's file

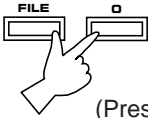
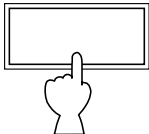
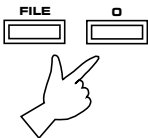
- 1 Turn the **POWER** off.
- 2  (Press and hold.)
- 3 
- 4  (Release.)

REPEAT PLAY

You can play any desired track or disc (set of discs) repeatedly by pressing the **REPEAT** button. The repeat play mode will change whenever you press the **REPEAT** button.

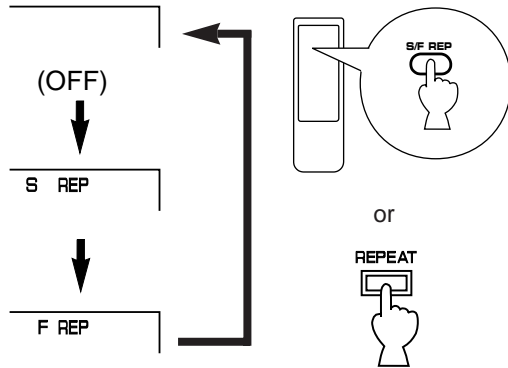

SINGLE REPEAT (S REP)

A single track is repeatedly played.

* This is also available in the programmed-play mode and the random-sequence play mode. (If the repeat play mode is switched off, the programmed-play mode or the random-sequence play mode will be resumed.)

FULL REPEAT (F REP)

In the "SINGLE" disc play mode: A designated disc is repeatedly played.

In the "ALL" disc play mode: All discs in the disc tray are repeatedly played.

* In the programmed-play mode, all programmed tracks are repeatedly played.

* In the random-sequence play mode, all randomly sequenced tracks are repeatedly played in the same order.

INDEX SEARCH

If the disc includes index numbers, play can be started from any desired index number.

- 1 Select a track which has index numbers.

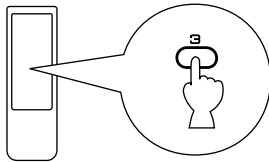

- 2

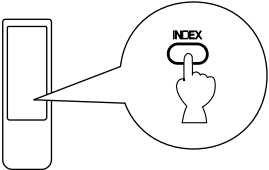

- 3 Select the desired index number.

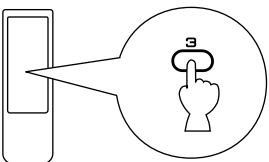

To cancel the index search function

Press the **INDEX** button.

Notes

- Not all discs have index numbers. The index system is a method for sub-dividing tracks into smaller divisions (such as, for example, the movements within classical symphonies) for easier location of those parts. The liner notes with the disc usually tell if such index numbers are included.
- If an index number is selected that is higher than any index number on that disc, play will start from the last index number point on the disc.
- For some discs, play may begin slightly prior to the actual designated index point.
- If the disc has no encoded index points, play will begin from the start of the selected track.
- The index number can be designated only while the INDEX number display is illuminated.

TRACK PROGRAMMING FOR RECORDING TO TAPE

This convenient feature can be used to program tracks for recording to tape. By only memorizing the tape's total possible recording time, the unit will automatically program tracks or help you to program tracks so they will fit onto the tape with the least amount of unrecorded space remaining at each end of the tape.

Automatic tape programming

This is useful for recording a disc onto tape with the order of tracks unchanged.

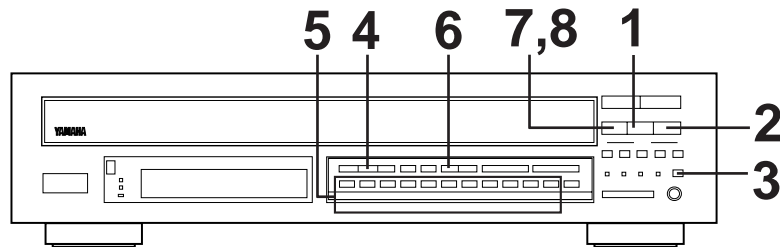

1 Stop the unit.



2 Select the disc.



3 If necessary, select any desired DEQ-mode.

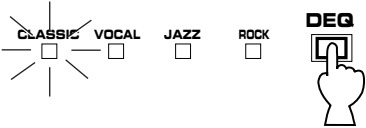

4 Enter the tape's total possible recording time.



You can select any of four tape lengths by pressing the **TAPE** button.

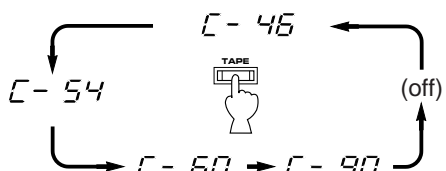

5 Otherwise, you can also enter the tape's total possible recording time manually.

Example: For a C-64 tape (32 minutes on each side)

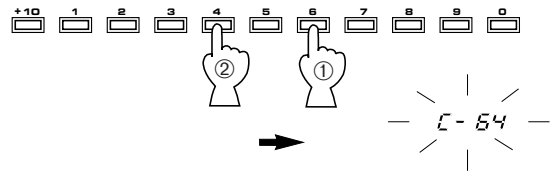

6



* By pressing the **REPEAT** button, the unit automatically programs tracks for side A and side B separately considering the tape's total time.

7 Begin recording on the tape deck and press the **PLAY/PAUSE** button on this unit at the same time.

8 The unit will pause at the end of side A of the tape. Turn the tape over to side B. Resume recording and, at the same time, press the **PLAY/PAUSE** button on this unit.

Notes

- All tracks may not be programmed if the tape's length is not enough. To program all tracks, use a longer tape.
- In step 6, you can check the program data for side A and side B.

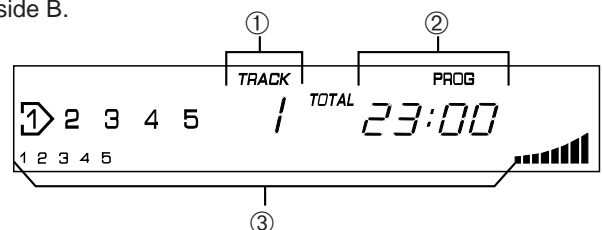

- ① Shows the number of the first programmed track for each side.
- ② Shows the total time of programmed tracks for each side.
- ③ Shows the programmed track numbers for each side.

Manual tape programming

This is useful for recording desired tracks selected from one or several discs in any desired order onto tape.

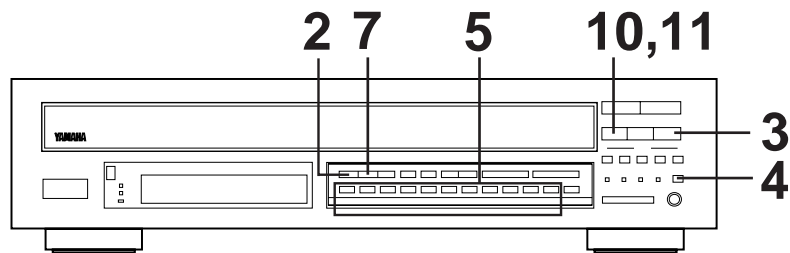

1 Follow step 1, 4 and 5 on page 17.

2 Flashes on and off.

3 If necessary, select the desired disc.



4 If necessary, select any desired DEQ-mode.

5 Select the desired track.

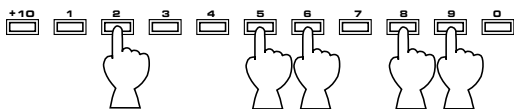

6 Repeat step 3–5 to set more programs for the side A of the tape. You can select the same track again.

* If “E rr” appears in the display, the track number just selected cannot be programmed because there is not enough time remaining on the side A of the tape.

7 After you finish the programming for the side A, program the pause mode by pressing the **TAPE** button.



* “Pu” flashes in the display, and after then you can begin programming for side B.

8 Follow step 3–5.

9 Repeat step 3–5 to set more programs for the side B of the tape. You can select the same track again.

* If “E rr” appears in the display, the track number just selected cannot be programmed because there is not enough time remaining on the side B of the tape.

10 Begin recording on the tape deck and press the **PLAY/PAUSE** button on this unit at the same time.

11 The unit will pause at the end of side A of the tape. Turn the tape over to side B. Resume recording and, at the same time, press the **PLAY/PAUSE** button on this unit.

Notes

- If you will program tracks from more than one disc, before you press the **PROG** button, check the total recorded time of each disc on the disc tray by pressing the **DISC SKIP** button in turn. Without this operation, the total remaining time of each side of the tape and previously programmed track numbers (and also unprogrammed track numbers) will not be displayed during programming.
- In step 6 and 9, even if “E rr” appears in the display, you can program another track of which time is shorter than the remaining time on the side of the tape. In this case, you can check the remaining time on the side of the tape by pressing the **TIME** display mode-select button.

Notes on tape programming

- To check, cancel or correct program data, refer to page 13.
- The maximum number of tracks that can be programmed is 40. If, however, the **PAUSE** mode is inserted, it is counted as one track.
- This function can be used to program up to track number 20. If the disc has more than 20 tracks, track number 21 and thereafter will not be programmed.

Display information during programming

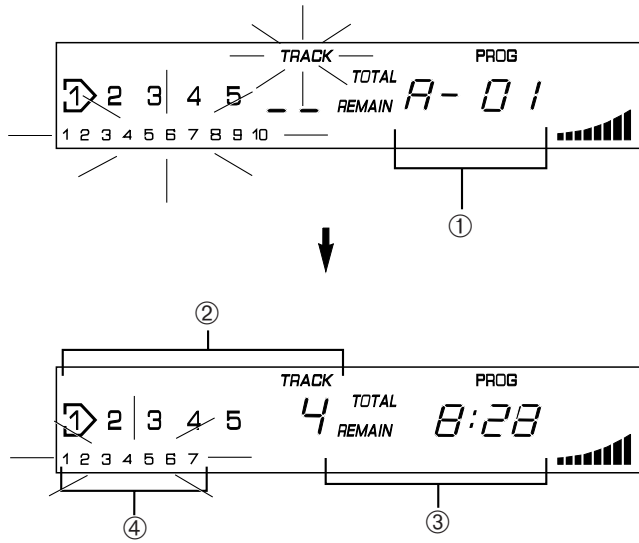

- ① Shows the side of the tape and the program number for the track to be set next.
- ② Shows the selected disc and track number.
- ③ Shows the total remaining time on the side of the tape.
- ④ Programmed track numbers illuminate and unprogrammed ones flash on and off.

* If "A-01" does not appear in the display after the **PROG** button is pressed, press the **TIME** display mode-select button.

■ Random sequential tape programming

The unit will automatically program tracks on a disc in random sequential order for recording to tape.

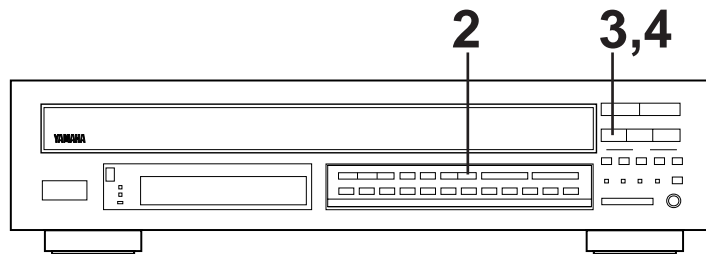

1 Follow step 1 – 5 on page 17.



* The unit will automatically program tracks for side A and side B separately considering the tape's total time.

3 Begin recording on the tape deck and press the **PLAY/PAUSE** button on this unit at the same time.

4 The unit will pause at the end of side A of the tape. Turn the tape over to side B. Resume recording and, at the same time, press the **PLAY/PAUSE** button on this unit.

Notes

- Because the programmed data changes every time the **RANDOM** button is pressed, the amount of time remaining at the end of the tape also changes accordingly.
- If the tape's length is not enough, all tracks cannot be programmed. In this case, exchange the tape for a longer one.
- In step 2, you can check the program data for side A and side B.

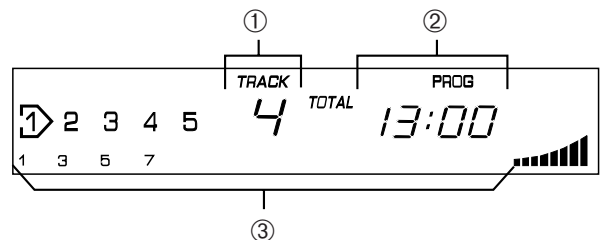

- ① Shows the number of programmed tracks for each side.
- ② Shows the total time of programmed tracks for each side.
- ③ Shows the programmed track numbers for each side.

RELAY PLAY

If you have two CDC-835s, you can enjoy any combination play of ten discs by connecting them to each other.

Connections

At first, determine which CDC-835 is to be used as the main unit (or the second one). Connections should be made as shown in the following figure.

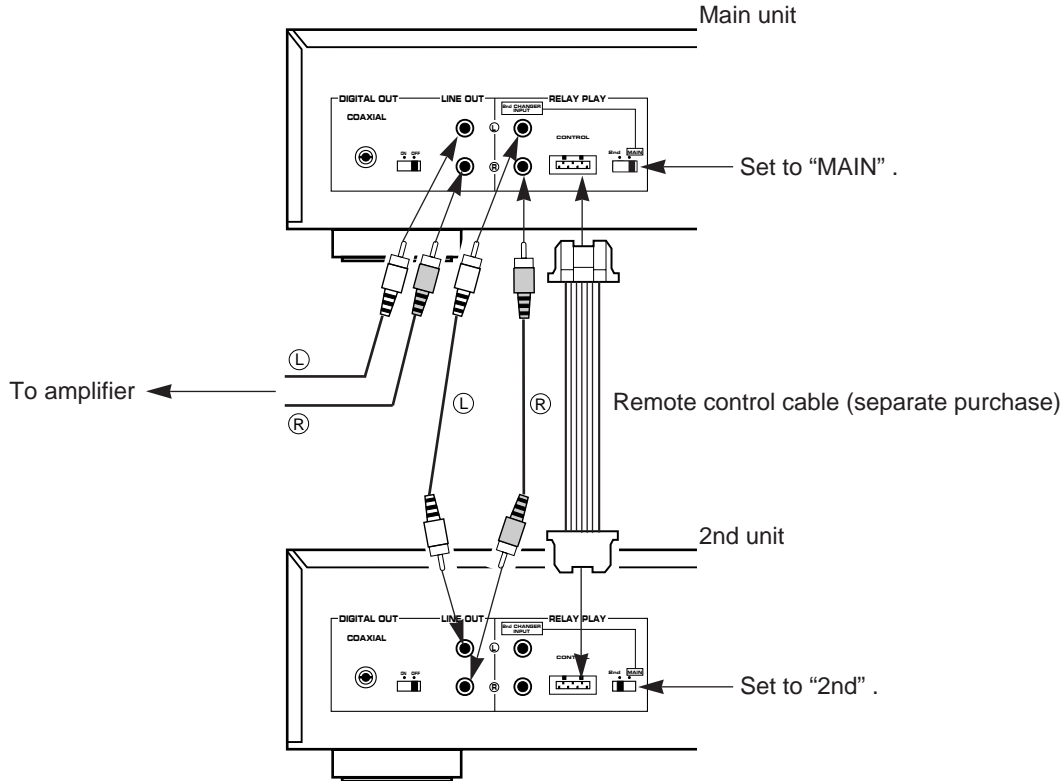

- The 2nd/MAIN switch should be set while the units are in the power-off mode.
- When the units are not connected to each other, the "2nd/MAIN" switch on the rear panel of each unit should be set to the "MAIN" position.
- Be sure to set the DIGITAL OUT ON/OFF switch on the rear of each unit to the "OFF" position.
- Relay play cannot be done if the DIGITAL OUT (COAXIAL) terminal of the main unit is used for the connection to the amplifier.

Disc play

If the power of both the units is switched on simultaneously, you can begin play from the first disc in the main unit. The operating methods are the same as the normal disc play.

In the "SINGLE" disc play-mode

Discs are played alternately between the two units in sequence.

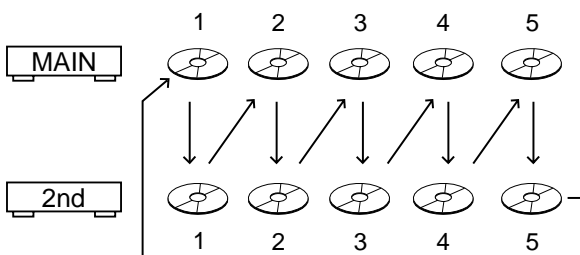

In the "ALL" disc play-mode

After playing all discs in one unit, play will be switched to the other automatically.

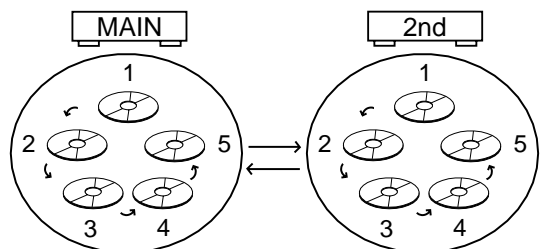

Notes

- In relay play, one unit is in the “functioning” mode and the other in the “waiting” mode.

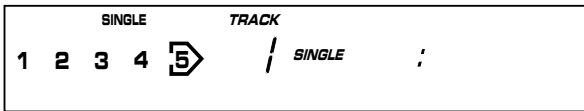

- * The display like this shows that the unit is in the “waiting” mode.
- In the “SINGLE” disc play-mode, a waiting time for the alternation of discs is shorter than the “ALL” disc play-mode.
- By setting the power of one unit off, you can use another unit normally (without relay play).
- The **OUTPUT LEVEL** control, disc play **MODE**-select button and **DEQ** button of each unit can be set respectively.

To begin play from a desired disc

Press the corresponding **DISC**-select button on the corresponding unit.

Program play (in relay play)

In the “ALL” disc play-mode, program play is performed in each unit.

In the “SINGLE” disc play-mode, only the programmed disc in each unit is played with that program data.

If the “FILE” indicator is illuminated, only discs which have their own program data in the memory’s file are played with the program data.

Random-sequence play (in relay play)

In the “SINGLE” disc play-mode, random-sequence play is performed in each disc.

In the “ALL” disc play-mode, random-sequence play is performed in all discs of each unit.

Repeat play (in relay play)

When a unit is in the repeat-play mode, relay play can not be performed.

About using the remote control transmitter

Signals from the remote control transmitter are always received by the “functioning” unit.

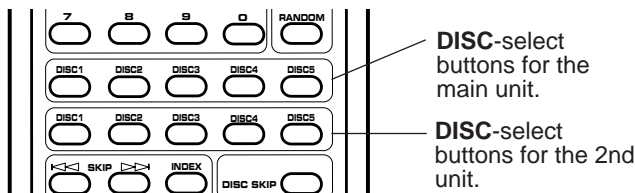

- * If any **DISC**-select button for the “waiting” unit is pressed, play will begin from the corresponding disc.
- * You can switch a unit from the “functioning” to the “waiting” mode by pressing the **STOP** button of the “functioning” unit when the unit is stopped. If during playing, press the **STOP** button twice.

NOTES ABOUT THE REMOTE CONTROL TRANSMITTER

Battery installation

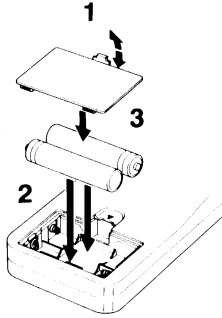

Remote control transmitter operation range

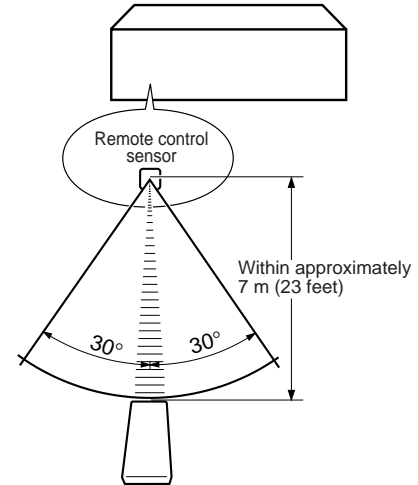

Battery replacement

If you find that the remote control transmitter must be used closer to the main unit, the batteries are weak. Replace both batteries with new ones.

Notes

- Use only AA, R6, UM-3 batteries for replacement.
- Be sure the polarities are correct. (See the illustration inside the battery compartment.)
- Remove the batteries if the remote control transmitter will not be used for an extended period of time.
- If batteries leak, dispose of them immediately. Avoid touching the leaked material or letting it come in contact with clothing, etc. Clean the battery compartment thoroughly before installing new batteries.

Notes

- There should be no large obstacles between the remote control transmitter and the main unit.
- If the remote control sensor is directly illuminated by strong lighting (especially an inverter type of fluorescent lamp etc.), it might cause the remote control transmitter to not work correctly. In this case, reposition the main unit to avoid direct lighting.

NOTES ABOUT HANDLING COMPACT DISCS

- This compact-disc player is designed only for playing of compact discs bearing the  mark. Never attempt to load any other type of disc into the unit. The unit will also play 3-inch (8-cm) compact discs.
- To remove a disc from its storage case, open the case and then press down at the center; with a finger through the center hole and the outer edges held as shown in the illustration, lift the disc out carefully.

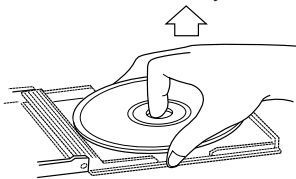

- Always handle the disc with care so that its surface is not scratched.

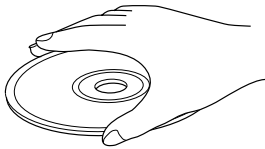

- Compact discs are not subjected to wear during play, but damage to the disc surface when the disc is being handled can adversely affect the disc's play.

- Compact discs are not affected by small particles of dust or fingerprints on their playing surface, but even so they should be kept clean. Wipe by using a clean, dry cloth. Do not wipe with a circular motion; wipe straight outward from the center.

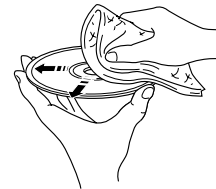

- Do not try to clean the disc's surface by using any type of disc cleaner, record spray, anti-static spray or liquid, or any other chemical-based liquid, because such substances might irreparably damage the disc's surface.
- Do not expose discs to direct sunlight, high temperature or high humidity for a long period of time, because these might warp or otherwise damage the disc.



To play a 3-inch (8-cm) CD

Place it in the inner recessed area of the disc tray. Do not put a normal (5-inch/12-cm) CD on top of a 3-inch CD.

TROUBLESHOOTING

If the unit fails to operate normally, check the following points to determine whether the problem can be corrected by the simple measures suggested. If it cannot, or if the problem is not listed in the SYMPTOM column, disconnect the unit's power cord and contact your authorized YAMAHA dealer or service center for assistance.

SYMPTOM	PROBABLE CAUSE	REMEDY
The player does not switch ON when the POWER switch is pressed.	The power cord is not connected or not completely connected.	Securely connect the power cord.
The disc tray does not close completely.	A foreign object is obstructing the tray.	Carefully check the disc tray and remove the foreign object.
A disc number does not illuminate in the display.	The disc has been loaded upside down.	Load the disc correctly.
	The disc is damaged.	Check the disc carefully; replace it if necessary.
	There is moisture on the laser pickup.	Wait 20 to 30 minutes after switching the unit ON before trying to play a disc.
Play does not begin.	The disc has been loaded upside down.	Reload the disc with the label side up.
	The disc is dirty.	Clean the disc.
Play is delayed, or begins at the wrong place.	The disc may be scratched or damaged.	Check the disc carefully; replace it if necessary.
No sound.	Improper output cable connections.	Connect the cables properly. If the problem persists, the cables may be defective.
	Improper amplifier operation.	Set the amplifier controls to the correct input selection.
Sound "skips".	The player is being subjected to vibrations or impacts.	Relocate the player.
	The disc is dirty.	Clean the disc.
Sound "hums".	Improper cable connections.	Securely connect the audio cables. If the problem persists, the cables may be defective.
Noise from a nearby tuner.	The tuner is too close to the player.	Move the tuner and player farther apart.
Noise from inside of the disc tray.	The disc may be warped.	Replace the disc.
The remote control transmitter does not work.	Direct sunlight or lighting (of an inverter type of fluorescent lamp etc.) is striking the remote control sensor of the main unit.	Change position of the main unit.

SPECIFICATIONS

AUDIO SECTION

Frequency response 2 Hz – 20 kHz, ± 0.3 dB
 De-emphasis equalization ± 0.3 dB
 Harmonic distortion+noise
 (with L.P.F.) Less than 0.0018% (1 kHz)
 S/N ratio 115 dB
 Dynamic range 100 dB
 Wow & flutter Unmeasurable
 Output voltage 2.0V
 Headphones output (–20 dB) 200 mV/150 ohms

GENERAL

Power requirements
 U.S.A. and Canada models 120V, 60 Hz
 Australia and U.K. models 240V, 50 Hz
 Europe model 230V, 50 Hz
 General model 110/120/220/240V, 50/60 Hz
Power consumption 20W
Dimensions (W x H x D) 435 x 107.5 x 387 mm
 (17-1/8" x 4-1/4" x 15-1/4")
Weight 6.5 kg (14 lbs. 5 oz.)
Accessories Connection cord
 Remote control transmitter
 Batteries (size AA, R6, UM-3)

Please note that all specifications are subject to change without notice.

YAMAHA

YAMAHA ELECTRONICS CORPORATION, USA 6660 ORANGETHORPE AVE., BUENA PARK, CALIF. 90620, U.S.A.
YAMAHA CANADA MUSIC LTD. 135 MILNER AVE., SCARBOROUGH, ONTARIO M1S 3R1, CANADA
YAMAHA ELECTRONIK EUROPA G.m.b.H. SIEMENSSTR. 22-34, D-25462 RELLINGEN BEI HAMBURG, F.R. OF GERMANY
YAMAHA ELECTRONIQUE FRANCE S.A. RUE AMBROISE CROIZAT BP70 CROISSY-BEAUBOURG 77312 MARNE-LA-VALLEE CEDEX02, FRANCE
YAMAHA ELECTRONICS (UK) LTD. YAMAHA HOUSE, 200 RICKMANSWORTH ROAD WATFORD, HERTS WD1 7JS, ENGLAND
YAMAHA SCANDINAVIA A.B. J A WETTERGRENS GATA 1, BOX 30053, 400 43 VÄSTRA FRÖLUNDA, SWEDEN
YAMAHA MUSIC AUSTRALIA PTY, LTD. 17-33 MARKET ST., SOUTH MELBOURNE, 3205 VIC., AUSTRALIA

YAMAHA CORPORATION
VN86140-0 Printed in Japan BWWR, G