

YAMAHA PORTATONE

PSR-SQ16

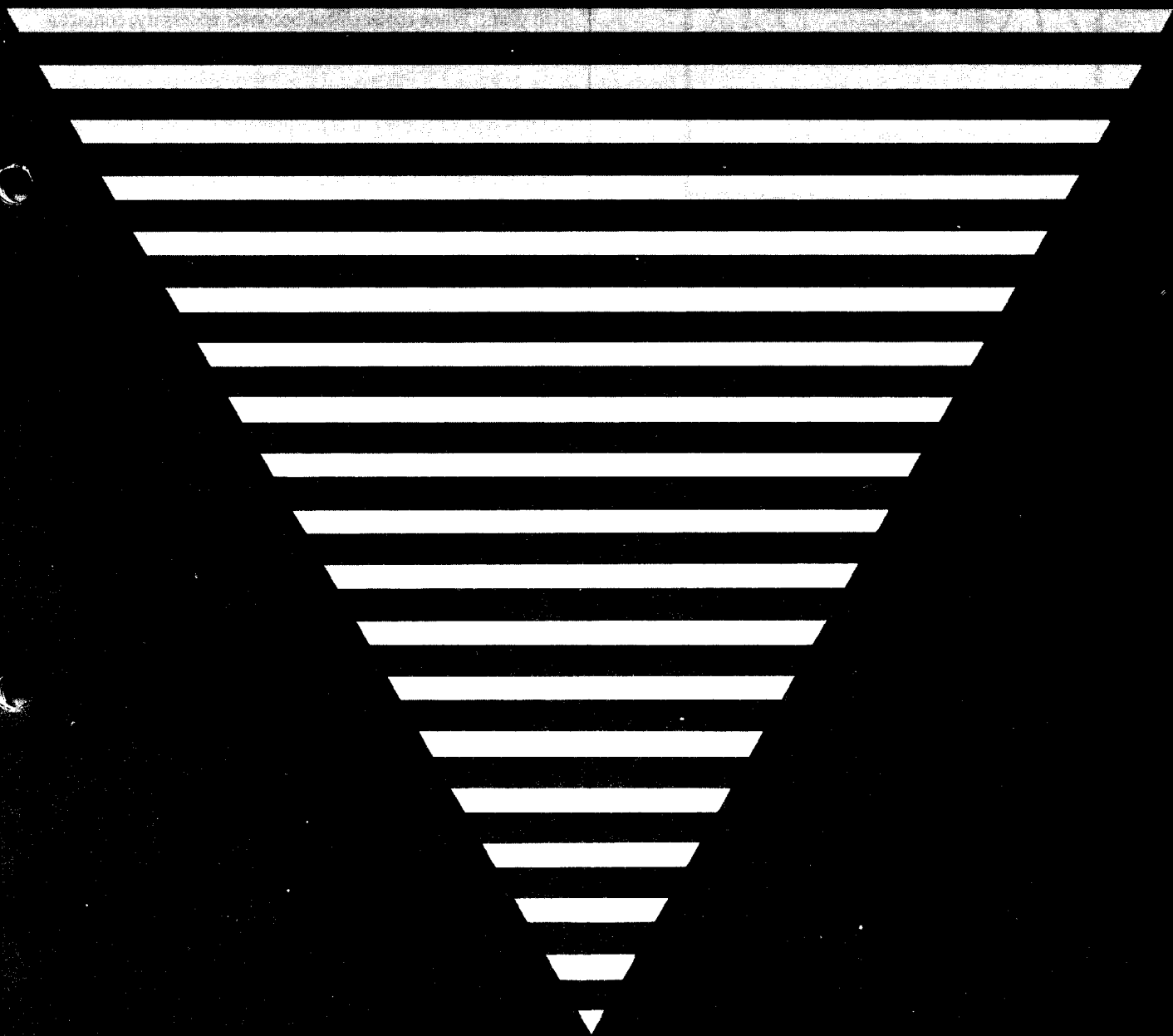

Owner's Manual

SPECIAL MESSAGE SECTION

PRODUCT SAFETY MARKINGS: Yamaha electronic products may have either labels similar to the graphics shown below or molded/stamped facsimiles of these graphics on the enclosure. The explanation of these graphics appears on this page. Please observe all cautions indicated on this page and those indicated in the safety instruction section.

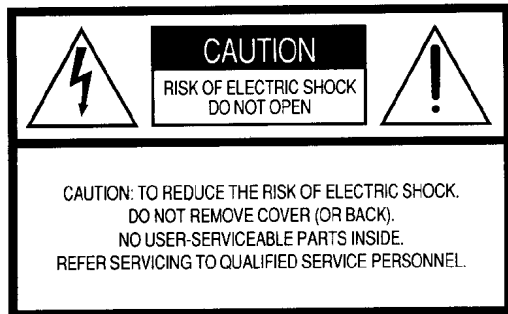

The exclamation point within the equilateral triangle is intended to alert the user to the presence of important operating and maintenance (servicing) instructions in the literature accompanying the product.

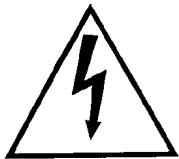

The lightning flash with arrowhead symbol within the equilateral triangle is intended to alert the user to the presence of uninsulated "dangerous voltage" within the product's enclosure that may be of sufficient magnitude to constitute a risk of electrical shock.

IMPORTANT NOTICE: All Yamaha electronic products are tested and approved by an independent safety testing laboratory in order that you may be sure that when it is properly installed and used in its normal and customary manner, all foreseeable risks have been eliminated. **DO NOT** modify this unit or commission others to do so unless specifically authorized by Yamaha. Product performance and/or safety standards may be diminished. Claims filed under the expressed warranty may be denied if the unit is/has been modified. Implied warranties may also be affected.

SPECIFICATIONS SUBJECT TO CHANGE: The information contained in this manual is believed to be correct at the time of printing. However, Yamaha reserves the right to change or modify any of the specifications without notice or obligation to update existing units.

ENVIRONMENTAL ISSUES: Yamaha strives to produce products that are both user safe and environmentally friendly. We sincerely believe that our products and the production methods used to produce them, meet these goals. In keeping with both the letter and the spirit of the law, we want you to be aware of the following:

Battery Notice: This product **MAY** contain a small non-rechargeable battery which (if applicable) is soldered in place. The average life span of this type of battery is approximately five years. When replacement becomes necessary, contact a qualified service representative to perform the replacement.

Warning: Do not attempt to recharge, disassemble, or incinerate this type of battery. Keep all batteries away from children. Dispose of used batteries promptly and as regulated by applicable laws. Note: In some areas, the servicer is required by law to return the defective parts. However, you do have the option of having the servicer dispose of these parts for you.

Disposal Notice: Should this product become damaged beyond repair, or for some reason its useful life is considered to be at an end, please observe all local, state, and federal regulations that relate to the disposal of products that contain lead, batteries, plastics, etc.

NOTICE: Service charges incurred due to lack of knowledge relating to how a function or effect works (when the unit is operating as designed) are not covered by the manufacturer's warranty, and are therefore the owners responsibility. Please study this manual carefully and consult your dealer before requesting service.

NAME PLATE LOCATION: The graphic below indicates the location of the name plate. The model number, serial number, power requirements, etc., are located on this plate. You should record the model number, serial number, and the date of purchase in the spaces provided below and retain this manual as a permanent record of your purchase.

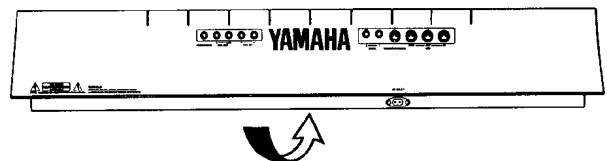

Model _____

Serial No. _____

Purchase Date _____

YAMAHA PORTATONE
PSR-SQ16

Owner's Manual

INTRODUCTION

Thank you for purchasing the YAMAHA PSR-SQ16. To obtain maximum performance and enjoyment from your new PSR-SQ16, we urge you to read this Owner's Manual carefully while trying out the features described. After you have become familiar with the features of the PSR-SQ16, keep this Owner's Manual in a safe place for future reference.

PSR-SQ16 FEATURES

- 61-note touch response keyboard for maximum expressive control.
- Powerful tone generator with 56-note maximum polyphony, which is also MIDI controllable as a 16-channel multi-timbral tone generator.
- Multi-track Keyboard System which combines the keyboard, tone generator, and a multi-track sequencer.
- Using the Configuration Table, the PSR-SQ16 can support a wide range of MIDI data or disk data, including the General MIDI Level 1 System.
- Proven superior by time, AWM (Advanced Wave Memory) tone generation offers 177 preset voices plus 23 percussion sets (including a total of 180 percussive sounds).
- 269 Auto Accompaniment styles provide a wide range from which to choose.
- The Custom Style function allows you to create your own original Accompaniment styles.
- The 16-track sequencer is easy to operate with one switch per function.
- The 3.5" Disk Drive enables performance data and Custom Style data storage.
(Standard MIDI File Format is used to allow the PSR-SQ16 to use some types of data or software from other MIDI sequencers.)
- Versatile DSP (Digital Signal Processor) effects.
- MIDI function provides a wide range of musical expressions with unlimited possibilities.

* General MIDI level 1 specifications do not apply to program numbers 120 through 127 (mainly sound effect functions).

HOW TO USE THIS MANUAL

The BASIC OPERATION section of this manual will quickly familiarize you with the basic functions of the PSR-SQ16. The ADVANCED FEATURES section of this manual provides detailed instructions on how to use all of the functions and controls of the PSR-SQ16. In addition to this manual, the "List Book" contains many useful lists and other data that will be referred to in the Owner's Manual.

CONTENTS

BEFORE YOU USE	4
NOMENCLATURE	
• Front Panel	6
• Rear Panel	8

BASIC OPERATION

VOICE SELECTION	10
• LAYERING TWO OR MORE VOICES	12
• KEYBOARD SPLIT	15
AUTO ACCOMPANIMENT	16
• WHAT IS AUTO ACCOMPANIMENT?	16
• FULL ACCOMPANIMENT BASICS	16
• USING THE AUTO ACCOMPANIMENT	18
PLAYING THE DEMONSTRATION SONG	24
• PLAYING THE INTERNAL DEMONSTRATION SONG	24
• DISK DEMONSTRATION SONGS	24

ADVANCED FEATURES

■ PSR-SQ16 SYSTEM CHART	28
1 KEYBOARD CHANNEL	30
2 CHANNEL STATUS	31
• VOICE Select	33
• VOLUME	33
• PAN	33
• DSP DEPTH	33
• VIBRATO DEPTH	33
• TUNING	34
■ Other CHANNEL STATUS values	34
• SUSTAIN ON/OFF	34
• EXPRESSION	34
• PITCH BEND	34
• PITCH BEND SENSITIVITY	35
3 KEYBOARD	36
• VELOCITY FIX	36
• TRANSPOSE	36
• Changing the SPLIT POINT	37
• NOTE PROCESSOR	37
• PITCH BEND RANGE	38
4 AUTO ACCOMPANIMENT	39
• STYLE SELECT	39
• AUTO ACCOMPANIMENT ON/OFF	39
• FINGERING	40
• ACCOMPANIMENT SECTIONS	40

5 SEQUENCER	42
• ABOUT THE SEQUENCER	42
• RECORDING	44
• PLAYBACK	46
• RECORDING ALONG WITH THE PLAYBACK	47
• RECORDING FROM A SELECTED MEASURE	47
• MULTI TRACK RECORDING	47
• RECORDING MODE (Type of Recording)	48
• RECORDING WITH AUTO ACCOMPANIMENT	50
• REPEAT RECORDING AND PLAYBACK	50
• STEP MODE	51
• ABOUT EDIT	53
■ CUSTOM STYLE	61
6 PEDAL ASSIGN	64
7 TEMPO	65
8 DISK	66
• FORMATTING (Initializing)	69
• SAVE	70
• LOAD	71
• DELETE	73
• ERROR MESSAGE LIST	74
9 SOUND MODULE	76
• MASTER TUNING	76
• TRANSPOSE	76
• DSP TYPE setting	77
• CONFIG. TABLE settings (Configuration Table)	77
• How to make a CUSTOM TABLE	79
• How to set each parameter	79
10 MIDI	83
• MIDI connections	83
• I/O FILTER (Input/Output Filter)	84

Troubleshooting	85
Optional Accesories	85
PSR-SQ16 specifications	86
INDEX	86

List Book

Voice List
Drum Kit/Percussion List
Voice/Polyphony List
■ Maximum Polyphony
■ Polyphonic Voices
Style List
Configuration List
Initialization Method and Initialization Setting List
MIDI Data Format
Implementation Chart

BEFORE YOU USE

Your PSR-SQ16 is a fine musical instrument and, if properly cared for, will give you years of playing pleasure. Please follow the instructions below.

● Location

Do not expose the instrument to the following elements. Doing so can lead to damage, deformation, or discoloration.

- To direct sunlight (ex. near the window).
- To excessively high temperature (ex. near a heat source, outside, or in a car during the day).
- To excessive humidity.
- To excessive dust.
- To vibrations.

● Power Supply

(For power supply connections, please refer to page 8)

- When the equipment is not in use, turn off the power switch.
- Unplug the PSR-SQ16's power cord from its outlet if there is a threat of lightning, or if you will not use the PSR-SQ16 for a long period of time. However, first save data to a disk, because all internal data will be deleted and initialized (Refer to page 70).
- Avoid using the same AC outlet as appliances with a high consumption of electricity, such as TVs or ovens. Also avoid using multi-plug adapters. This can result in deteriorated sound quality or damage.

● Power off before connecting

- To avoid damage to the amplifier and speaker system, turn the power switches of both devices OFF before connecting them to another device.

● Handling and Transport

- Never apply excessive force to the controls, connectors, or other parts of the PSR-SQ16.
- Hold the plug firmly when unplugging the cord.
- Disconnect all cords before moving the unit.
- Dropping, hitting, or placing heavy objects on the instrument may result in scratches and damage.

● Cleaning

- Clean the outside panel with a dry, soft cloth.
- A slightly damp cloth may be used if more cleaning is necessary.
- Never use cleaners, such as alcohol or thinner.
- Avoid placing vinyl objects on top of the instrument, as they may stick to the surface.

● Electric Interference

- Since the PSR-SQ16 contains digital circuitry, it may cause interference if placed too close to radio or television receivers. If this occurs, move the instrument further away from the affected equipment.

● Data Saving

- Memory backup (for example, sequencer data) is supplied by AC power. If the power switch is turned off, memory will not be lost. However, if the power cord is unplugged, data in the memory will be lost. Save all important data to a disk before unplugging the unit.
- Memory data may be damaged due to incorrect operation. Be sure to "save" important data to a floppy disk. Also, magnetic fields can damage data on the disk, so it is advisable to make a "backup" copy of the disk.

● Use floppy disks and the disk drive carefully

- Do not bend or apply pressure to the floppy disk. Also, do not open the shutter and touch the floppy disk inside.
- Do not expose the disk to high temperatures (for example, direct sunlight)
- Use only 3.5" 2DD floppy disks.
- Do not expose the disk to magnetic fields. Data will be erased or destroyed.
- To eject a floppy disk, press the eject button slowly and completely. Remove the disk by hand only when it is fully ejected. If you press the eject button too quickly, or if you do not press it completely, it may become stuck in a half-pressed position, with the disk extending from the drive slot only a few millimeters. If this happens, do not attempt to pull out the partially ejected disk. Using force in this situation may damage the disk-drive mechanism or the floppy disk. To remove a partially ejected disk, try pressing the eject button once again, or push the disk back into the slot and then repeat the eject procedure properly.
- Do not insert anything but floppy disks into the disk drive of the unit, as foreign objects may cause damage to the disk drive or the floppy disk.

● Service and Modification

- The PSR-SQ16 contains no user serviceable parts. Opening it or tampering with it in any way can lead to electric shock or unit damage. Refer all repairs to qualified YAMAHA personnel.

YAMAHA is not responsible for damage caused by improper use.

NOMENCLATURE (Front Panel)

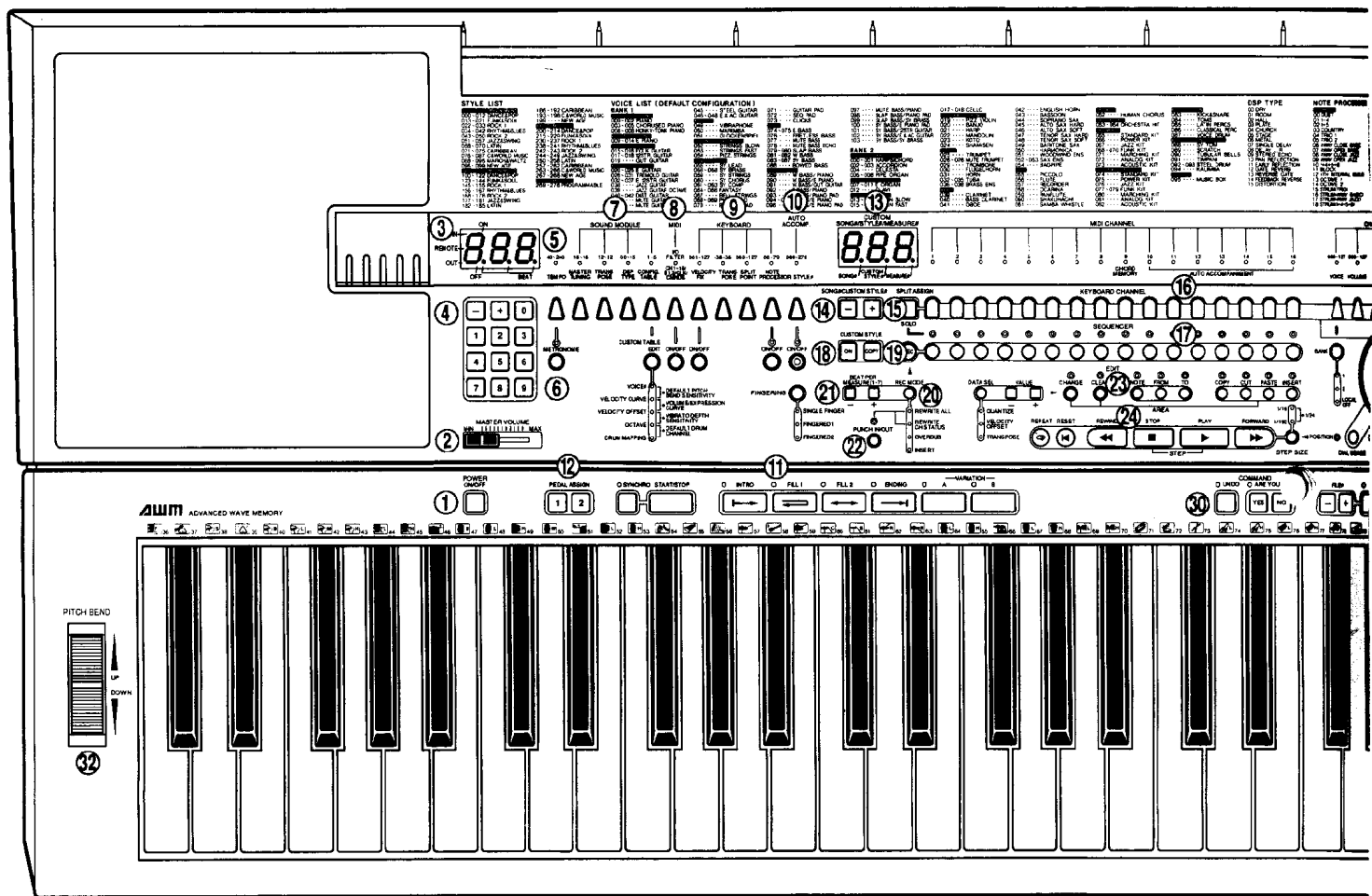

- | | | | |
|----------------------------------------------------|--------------|--------------------------------------|----------|
| ① POWER ON/OFF Button..... | P.10 | ⑨ KEYBOARD | |
| ② MASTER VOLUME Control | P.10 | • VELOCITY FIX Button | P.36 |
| ③ Left Display | P.18, 36, 84 | • VELOCITY FIX ON/OFF Button | P.36 |
| ④ Left Numeric Buttons (-, +, 0~9)..... | P.18, 36, 84 | • TRANSPOSE Button | P.36 |
| ⑤ TEMPO Button | P.18, 65 | • SPLIT POINT Button | P.37 |
| ⑥ METRONOME Button | P.65 | • NOTE PROCESSOR Button | P.37 |
| ⑦ SOUND MODULE | | • NOTE PROCESSOR ON/OFF Button | P.37 |
| • MASTER TUNING Button | P.76 | ⑩ AUTO ACCOMP. | |
| • TRANSPOSE Button | P.76 | • STYLE# Button | P.18, 39 |
| • DSP TYPE Button | P.77 | • ON/OFF Button | P.19, 39 |
| • CONFIG. TABLE Button | P.77 | • FINGERING Button | P.19, 40 |
| • CUSTOM TABLE EDIT Button | P.79 | ⑪ Accompaniment Control | |
| ⑧ MIDI | | • SYNCHRO Button | P.22 |
| • I/O FILTER (CH1~16/B1, 2/CLK/CMNDS) Button | P.84 | • START/STOP Button | P.22 |
| • I/O FILTER ON/OFF Button | P.84 | • INTRO→ Button | P.16, 22 |
| | | • FILL 1↔ Button | P.16, 23 |
| | | • FILL 2↔ Button | P.16, 23 |
| | | • ENDING→ Button | P.16, 23 |

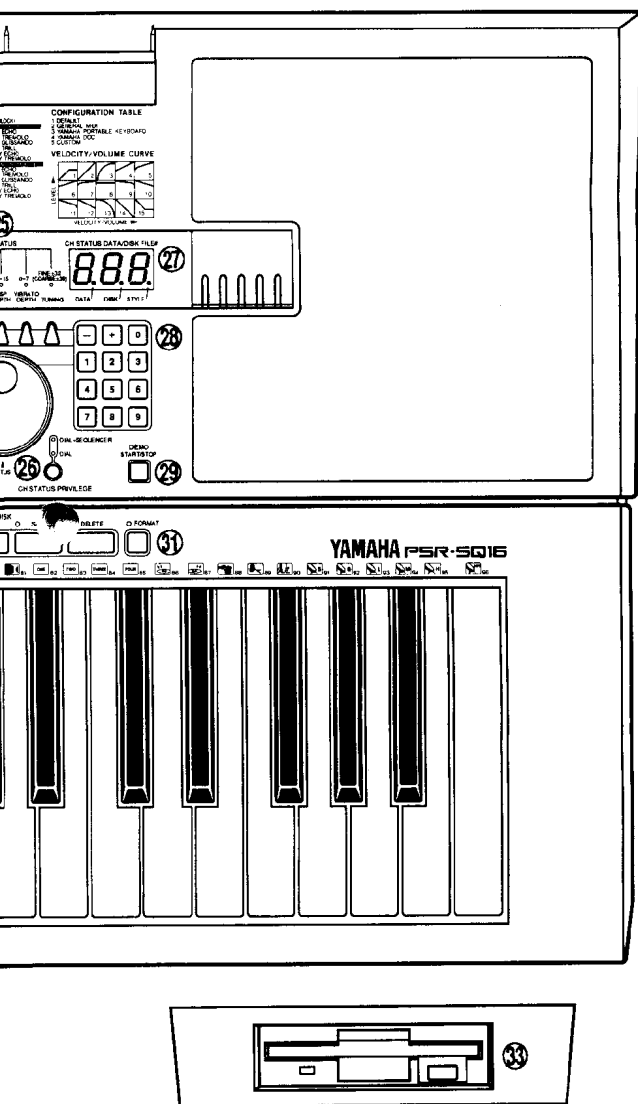

- VARIATION A/B Buttons P.16, 22
- ⑫ PEDAL ASSIGN 1, 2 Buttons P.64
- ⑬ Center Display P.26, 44, 61
- ⑭ SONG#/CUSTOM STYLE# (-, +) Buttons
..... P.26, 44, 61
- ⑮ SPLIT ASSIGN/SOLO Button P.15, 27, 46
- ⑯ KEYBOARD CHANNEL 1~16 Buttons P.12, 30
- ⑰ SEQUENCER 1~16 Buttons P.26, 44
- ⑱ CUSTOM STYLE ON/COPY Buttons P.61, 62
- ⑲ REC Button P.44
- ⑳ REC MODE Button P.48
- ㉑ BEAT PER MEASURE (1~7) Button P.45
- ㉒ PUNCH IN/OUT Button P.49
- ㉓ EDIT
 - DATA SEL Button P.55, 56, 57
 - VALUE -, + Buttons P.55, 56, 57

- CHANGE Button P.55, 56, 57
- CLEAR Button P.58
- NOTE Button P.54
- FROM Button P.54
- TO Button P.54
- COPY Button P.58
- CUT Button P.59
- PASTE Button P.59, 60
- INSERT Button P.59, 60
- ㉔ Sequencer Control
 - REPEAT ↺ Button P.50, 63
 - RESET ◀ Button P.46
 - REWIND ◀◀ Button P.46, 51
 - STOP ■ Button P.27, 45
 - PLAY ▶ Button P.27, 45, 46
 - FORWARD ▶▶ Button P.46, 51
 - STEP SIZE Button P.51
- ㉕ CHANNEL STATUS
 - VOICE Button P.10, 33
 - BANK Button P.10, 33
 - VOLUME Button P.33
 - PAN Button P.33
 - DSP DEPTH Button P.33
 - VIBRATO DEPTH Button P.33
 - TUNING Button P.34
- ㉖ DIAL
 - DIAL USAGE Button P.11, 32, 46
 - CH STATUS PRIVILEGE Button P.35
- ㉗ Right Display P.11, 25, 31, 70, 71
- ㉘ Right Numeric Buttons (-, +, 0~9) P.11, 31
- ㉙ DEMO START/STOP Button P.24
- ㉚ COMMAND
 - UNDO Button P.55
 - ARE YOU SURE? YES/NO Buttons
..... P.26, 44, 55, 69
- ㉛ DISK
 - FILE # (-, +) Buttons P.25, 70, 71, 73
 - LOAD Button P.26, 72
 - SAVE Button P.70
 - DELETE Button P.73
 - FORMAT Button P.69
- ㉜ PITCH BEND Wheel P.14, 34, 35, 38
- ㉝ Disk Drive
 - Disk Slot P.25, 69
 - Disk In Use Indicator P.25, 69
 - Disk Eject Button P.27, 69

NOMENCLATURE (Rear Panel)

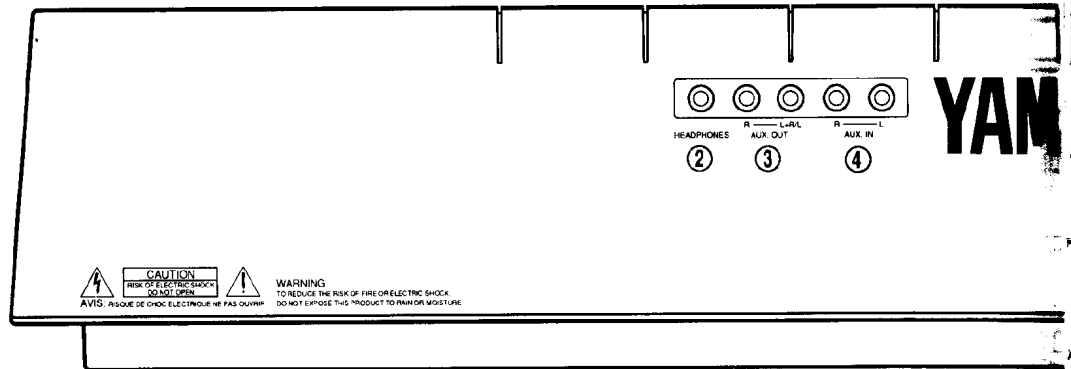

① AC INLET Jack

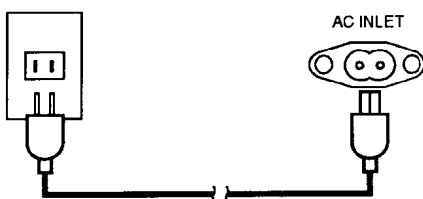

The provided AC power cord connects the PSR-SQ16 to an AC outlet. Always hold the plug firmly when connecting or disconnecting the cord.

② HEADPHONES Jack

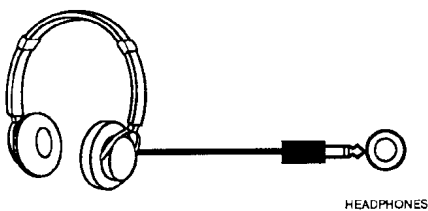

Plug a standard pair of stereo headphones into the rear-panel HEADPHONES jack for private listening. The internal stereo speaker system will shut off automatically when a pair of headphones is plugged into the HEADPHONES jack.

③ AUX. OUT (R, L+R/L) Jacks

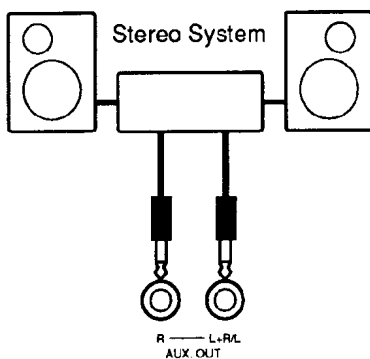

The rear-panel R and L+R/L jacks send the audio output of the PSR-SQ16 to any keyboard amplifier, stereo system, mixing console, or tape recorder. To connect the PSR-SQ16 to a monaural sound system, use the L+R/L jack only. The left-channel and right-channel signals are combined and delivered via the L+R/L jack.

NOTE: Never return the AUX. OUT (R, L+R/L) signal to the AUX or IN jacks, either directly or through external equipment. Doing so can cause damage to the internal devices.

④ AUX. IN (R, L) Jacks

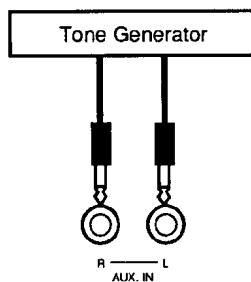

The AUX. IN (R) and (L) jacks are for receiving external audio signals. Connect external devices such as tone generators, drum machines, etc., to these jacks, and the PSR-SQ16 will receive the audio signal from these devices for reproduction by the internal amplifier and speaker system. (Use phone plugs when connecting these devices.) The PSR-SQ16's MASTER VOLUME cannot control the volume of external sources.

HA

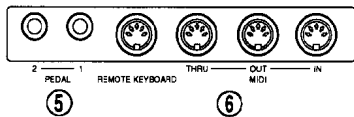

⑤ PEDAL 1, 2 Jacks

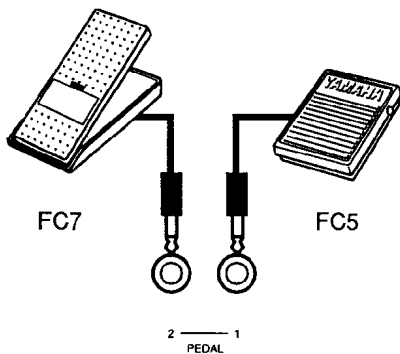

Connect an optional foot controller or foot switch to the PEDAL 1 or 2 jack to control a wide range of panel functions. For more information, refer to the "PEDAL ASSIGN" section on page 64.

⑥ MIDI (IN, OUT, THRU, REMOTE KEYBOARD) Connectors

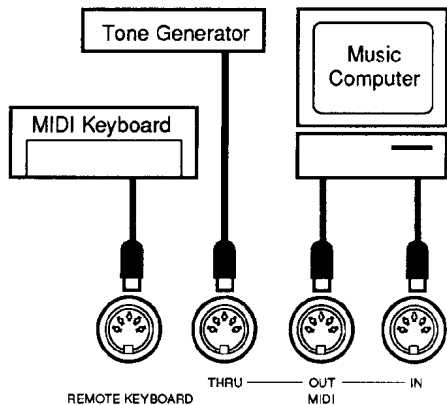

The MIDI IN and REMOTE KEYBOARD connectors receive MIDI data from external MIDI sources. The MIDI THRU connector re-transmits any data received by the MIDI IN connector directly to other MIDI instruments or devices. MIDI data generated by the PSR-SQ16 (note and velocity data performed on the keyboard) is transmitted via the MIDI OUT connector.

NOTE: Use only MIDI cables to connect the unit with other MIDI devices.

NOTE: The maximum length recommended for a MIDI cable is 15 meters. Cables longer than this may pick up interference, which can cause data errors.

The Music Stand

Attach the music stand by inserting the music stand's bottom into the PSR-SQ16's top panel slot.

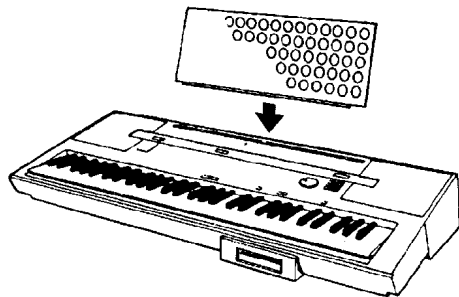



VOICE SELECTION

The PSR-SQ16 contains 200 vivid and realistic sounds created by Yamaha's time proven, superior AWM tone generation technology. Voices are separated into BANK 1 and BANK 2. Select a voice you like and try playing.

* Please refer to the "List Book" for a complete Voice list.

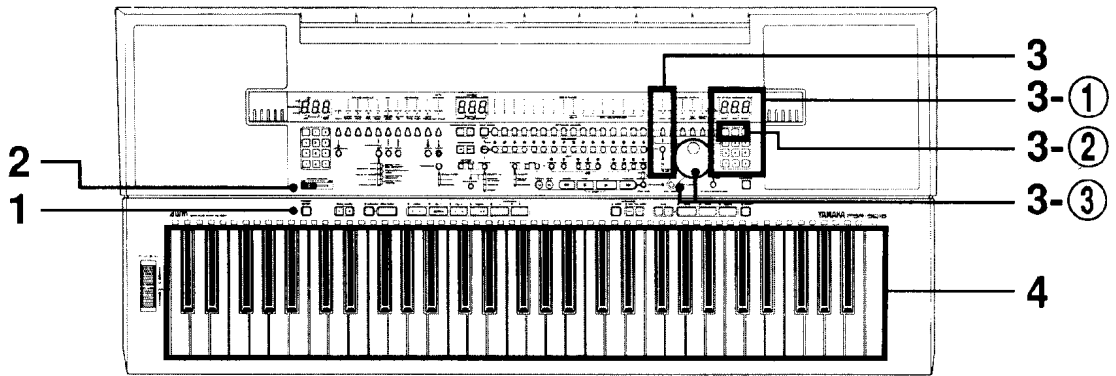

1. Switch POWER ON

Plug the AC power cord into a convenient AC outlet, and turn the POWER switch "ON".

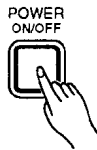

2. Set the MASTER VOLUME

The PSR-SQ16's overall sound is controlled by the MASTER VOLUME. Set the volume level to the half way point.

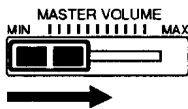

3. Voice selection

Try selecting Voice 008 (ELECTRONIC ORGAN 2), from BANK 2.

First, press the VOICE button, and its indicator will light. Next, press the BANK button, and the BANK "2" indicator will light. (Every time you press the BANK button, the three indicators will cycle in this sequence, BANK 1 → BANK 2 → LOCAL OFF → BANK 1.)

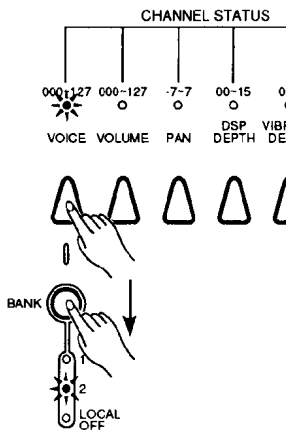

NOTE: For more information about the BANK button's LOCAL OFF indicator, refer to page 33.

At this point, use one of the following three ways to select a Voice.

① The numeric buttons



Use the numeric buttons located below the right-hand digital display to enter the three-digit number of the Voice you desire. In this case, press 0, 0, and 8. The number 008 will appear in the right-hand digital display.

② The + and - buttons



Use the + and - buttons located below the right-hand digital display to increase or decrease the Voice number by one. Hold down the + or - button to respectively increase or decrease the value continuously.

③ The DIAL

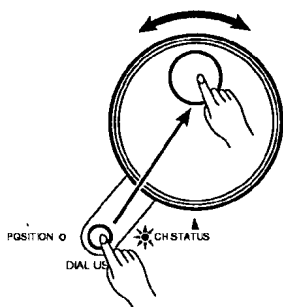

Press the DIAL USAGE button and the CH. STATUS indicator to its right will light. Turning the DIAL to the right causes the number in the right-hand digital display to increase, and turning it to the left causes the number to decrease. For more information, refer to DIAL USAGE on page 32.

NOTE: BANK 1 Voice numbers 104 through 127, and BANK 2 voice numbers 096 through 127 have no preset voices. Also, if the BANK indicator is set to LOCAL OFF, no sound can be produced.

NOTE: A Voice will change with the first note you play after changing the Voice number.

4. Play

After completing the above procedures, try playing the Voice you have selected. Try out some other Voices as well.

NOTE: If the Voice does not coincide with the Voice List number selected, the CONFIG. TABLE is not in its initial setting. For information on how to return the CONFIG. TABLE to its default setting, refer to page 78.

● Percussion Voice

Voice numbers 065 through 087 in BANK 2 are percussion voices, with no pitch preset, and individual instruments are assigned to each key. For Voice numbers 065 STANDARD KIT and 074 STANDARD KIT W/GATE, the symbols printed above the keys display the rhythm and percussion instruments assigned to the keys. Refer to these symbols when using either of these percussion voice numbers. For Voice numbers 066 through 087, refer to the Drum Kit/Percussion note assignment chart in the "List Book".

* When using the percussion voices, you can create and use your own original rhythm styles. For more information, refer to the Custom Style section on page 61.

* Voices 065 (STANDARD KIT) through 073 (ACOUSTIC KIT) are "one-shot type" percussion voices (Releasing the key will not effect note length). Voices 074 (STANDARD KIT) through 082 (ACOUSTIC KIT) are "gate type" percussion voices (Releasing the key will cut the sound off at that point). These Voices have the same sounds as Voices 065 through 073.

VOICE SELECTION

LAYERING TWO OR MORE VOICES

● About the KEYBOARD CHANNEL

The PSR-SQ16 has 16 programmable Keyboard Channels. Each channel can be assigned a separate Voice. If Voices (and their individual "CHANNEL STATUS" settings) are assigned to multiple keyboard channels, Voices can be switched at a touch. Let's assign a Voice to a Keyboard Channel.

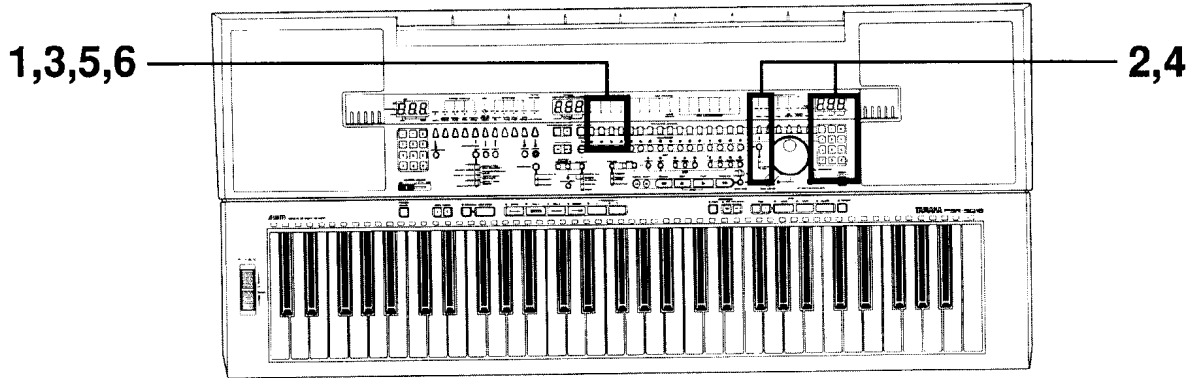
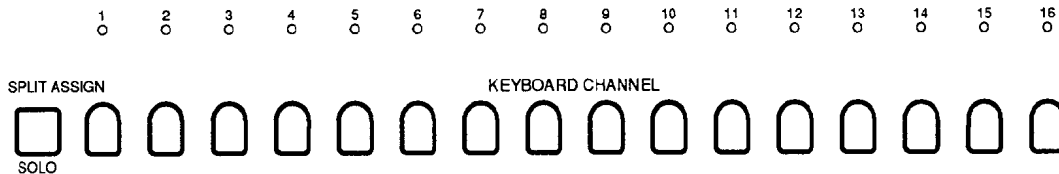

1. Select a KEYBOARD CHANNEL

Press the KEYBOARD CHANNEL 2 button, and its indicator will light.

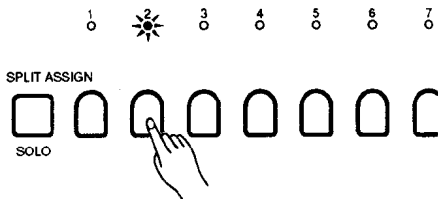

2. Select a Voice

Press the VOICE button, and its indicator will light. Follow the instructions described on page 10 to select BANK 1, Voice 002 (PIANO 3).

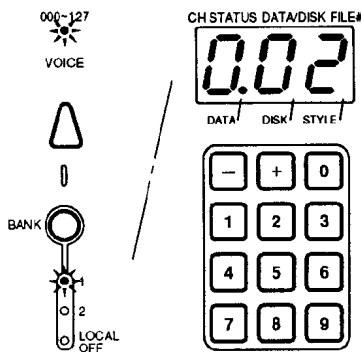

3. Select another Keyboard Channel

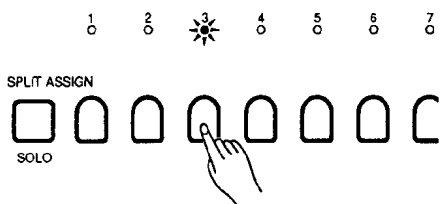

Press the KEYBOARD CHANNEL 3 button, and its indicator will light.

4. Select another Voice

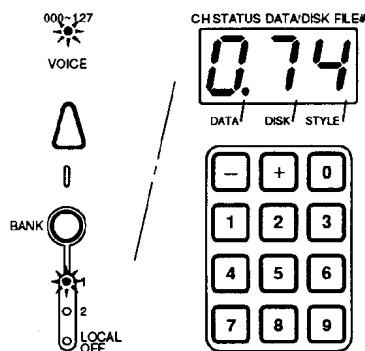

Set KEYBOARD CHANNEL 3 to BANK 1, Voice 074 (ELECTRIC BASS 1). This sets KEYBOARD CHANNEL 1 to BANK 2 Voice 008 (ELECTRONIC ORGAN 2), KEYBOARD CHANNEL 2 to BANK 1 Voice 002 (PIANO 3), and KEYBOARD CHANNEL 3 to BANK 1 Voice 074 (ELECTRIC BASS 1).

5. Switch voices and play

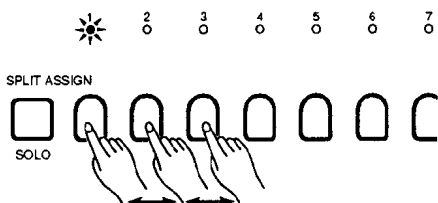

Press KEYBOARD CHANNEL buttons 1, 2, or 3 to switch between Voices. Try playing each sound yourself.

NOTE: A Voice will change with the first note you play after changing the Keyboard Channel.

6. Layer two voices

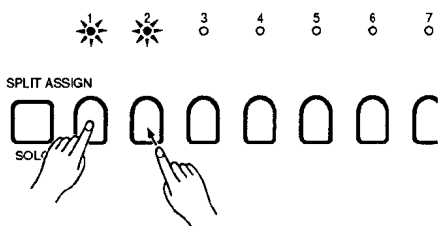

The remarkable characteristic of Keyboard Channels is that the PSR-SQ16 can "layer" two or more Channels.

Hold down the KEYBOARD CHANNEL 1 button, and press the KEYBOARD CHANNEL 2 button. The indicators of both will light. Now play the keyboard. The ELECTRONIC ORGAN 2 and PIANO 3 Voices will be heard simultaneously.

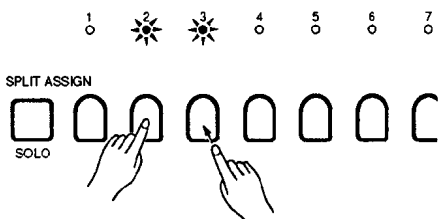

Next, hold down the KEYBOARD CHANNEL 2 button, and press the KEYBOARD CHANNEL 3 button. The indicators of both will light. Play the keyboard. The PIANO 3 and ELECTRIC BASS 1 sounds will be heard simultaneously.

VOICE SELECTION

7,8

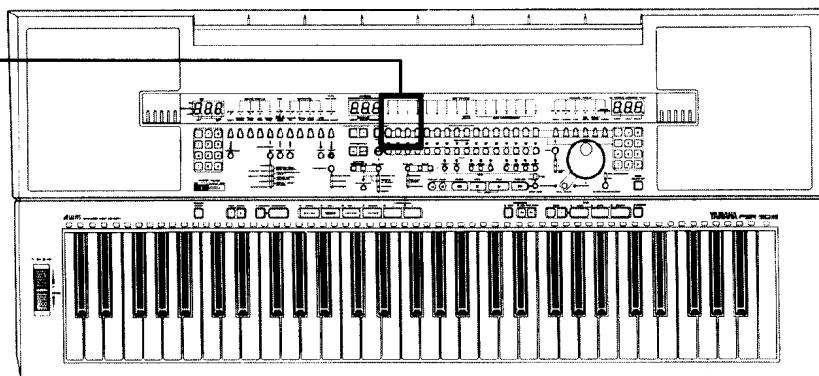

7. Layer 3 or more voices

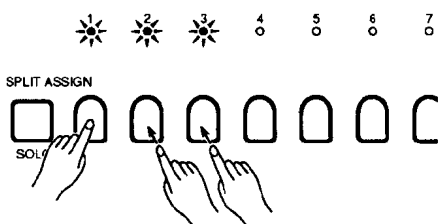

Hold down the KEYBOARD CHANNEL 1 button, then press the KEYBOARD CHANNEL 2 button and KEYBOARD CHANNEL 3 button, and all three indicators will light. When keys are played on the keyboard, all three voices, ELECTRIC ORGAN 2, PIANO 3, and ELECTRIC BASS 1, will be heard simultaneously.

* Holding down the first assigned KEYBOARD CHANNEL button and pressing any other KEYBOARD CHANNEL buttons allows you to layer a maximum of 16 voices.

NOTE: The maximum number of channels available is 16. However, the maximum polyphony is 28 notes per Bank (i.e., only 28 notes per bank can be played from the keyboard simultaneously). Because of this limitation, notes played beyond the polyphony limit will override previous notes. For more information, refer to the "Voice/Polyphony List" in the "List Book".

8. Activate only one channel

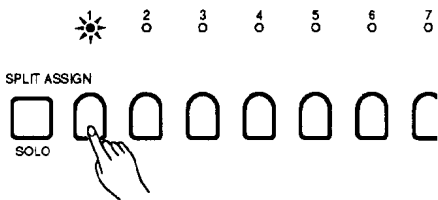

Press Keyboard Channel 1 button, and the indicators for Keyboard Channel 2 and 3 will go out (Keyboard Channels 2 and 3 will be deactivated). Now when the keyboard is played, only Keyboard Channel 1 voice [ELECTRONIC ORGAN 2] will sound.

* When multiple Keyboard Channels are on, pressing the button of any Keyboard Channel will activate that Channel only, and all previously activated Keyboard Channels will be turned off.

HINT

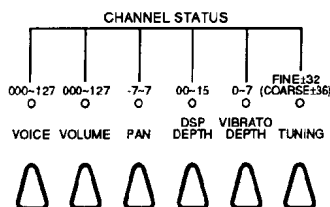

Use the functions in the CHANNEL STATUS section (VOLUME, PAN, and DSP DEPTH, etc.) as described on page 33, to make detailed adjustments to each selected Voice. These functions affect the sound of each Voice.

PITCH BEND

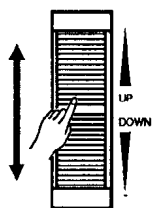

PITCH BEND

If you roll up or down the PITCH BEND wheel located on the left of the keyboard, the notes played will be bent up or down, much like a guitar's bending effect. For more information on the PITCH BEND wheel, refer to page 38.

KEYBOARD SPLIT

The Split mode allows you to “split” the keyboard into two sections, and play one voice in the left-hand section and another voice in the right-hand section. The default split point setting is B2 (59: this number is printed above the key, indicating its MIDI note number). To change the Split point, refer to page 37.

* In this section, we will use the Voices set to Channels 1 and 2 in the previous section (page 10 - 12).

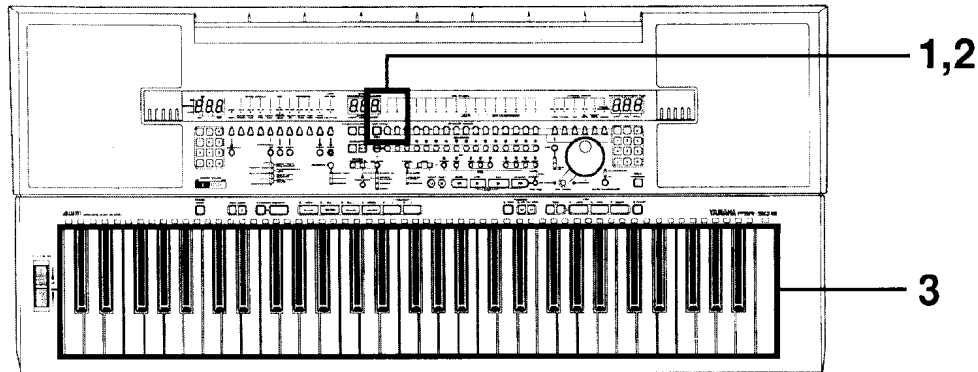

In this section, we will set the KEYBOARD CHANNEL 1 Voice (ELECTRIC ORGAN 2) to the right-hand section of the keyboard, and the KEYBOARD CHANNEL 2 Voice (PIANO 3) to the left-hand section.

1. Select the first Channel (Right-hand section channel)

Press the KEYBOARD CHANNEL 1 button, and its indicator will light.

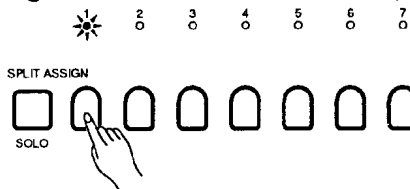

2. Select the second Channel (Left-hand section channel)

Next, hold down the SPLIT ASSIGN button. Then, press the KEYBOARD CHANNEL 2 button, and its indicator will flash.

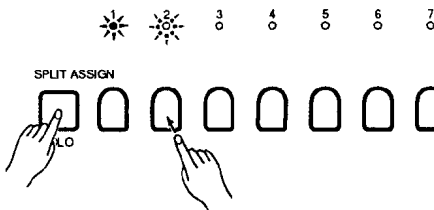

3. Let's play

After releasing the SPLIT ASSIGN button, the indicator of Keyboard Channel 1 will light (the right-hand section), and the indicator of Keyboard Channel 2 will flash (the left-hand section). This indicates that the keyboard has been Split. Play the keyboard in the Split mode, and the right-hand section of the keyboard will be set to KEYBOARD CHANNEL 1 (ELECTRONIC ORGAN 2), and the left-hand section will be set to KEYBOARD CHANNEL 2 (PIANO 3).

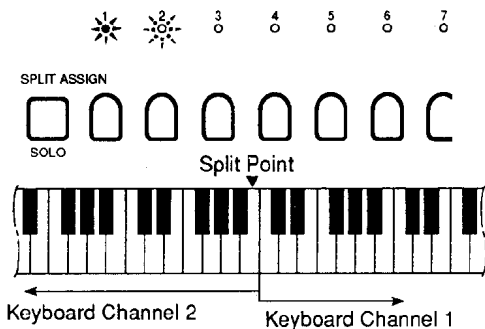

* Set any note on the keyboard as the Split Point. To change the Split Point, refer to page 37.

* Exit the split mode by holding down the SPLIT ASSIGN button again and pressing the KEYBOARD CHANNEL 2 button.

AUTO ACCOMPANIMENT

WHAT IS AUTO ACCOMPANIMENT?

With the PSR-SQ16 Auto Accompaniment mode, playing in the left-hand section of the keyboard (all keys left of and including the split point. Refer to page 37) will produce a completely orchestrated accompaniment according to the chords performed. The PSR-SQ16 covers a wide musical range with a total of 269 preset styles. In addition, the Custom Style function allows you to create your own styles.

The following is a breakdown of the 269 Accompaniment Styles.

● **Full Accompaniment** (100 types; 000 through 099)

This style consists of Intro, Main, Fill 1, Fill 2, and Ending sections, with each section having an A and B Variation. Therefore, Full Accompaniment styles have a total of ten sections.

● **Part Accompaniment** (100 types; 100 through 199)

This simple Accompaniment style consists of only the Main Section. Intro, Fill 1, Fill 2, Ending, and Variation A and B sections do not apply to this style.

● **Rhythm Style** (69 types; 200 through 268)

This rhythm-only style consists of only percussion and drum kit sounds. Intro, Fill 1, Fill 2, Ending and Variation A and B sections do not apply to this style.

Custom Style, style number's 269 through 276, allows you to create up to 8 original accompaniments. For more information, refer to the Custom Style section on page 61.

* A complete Style List can be found in the List Book.

FULL ACCOMPANIMENT BASICS

■ Full Accompaniment Sections

Full Accompaniments include Intro, Main, Fill 1, Fill 2, and Ending sections, and each section's A and B variations. These sections provide structured variety to a song. By selecting different sections while the Accompaniment plays, it is possible to match the proper section with the proper timing.

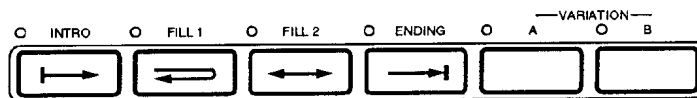

[Section] A "Section" refers to a portion of a song. The following describes the four sections of the PSR-SQ16.

- **INTRO** section Introduction of a song. (1-8 measures)
- **MAIN** section The main portion of an Accompaniment. The MAIN section plays when all other indicators (INTRO, FILL 1 and 2, ENDING) are off.
- **FILL IN** section ([FILL 1] and [FILL 2]) This section provides accents or a lead-in to the next section. (1 measure)
- **ENDING** section ... The Ending phase, just before a song finishes. (2-8 measures)

[Variation] The INTRO, MAIN, FILL 1 and 2, and ENDING sections all have two variations (A and B).

- **Variation A** A conservative accompaniment style.
- **Variation B** A flashy accompaniment style.

■ Relationships Between Sections

- **Intro section** When the Intro has completed, an Accompaniment will go directly to the Main section of the same Variation.
- **Main section** The same pattern will continuously repeat.
- **Fill 1 section** After a Fill-in 1 has completed, the Accompaniment will go directly to the Main section of the same Variation.
- **Fill 2 section** After a Fill-in 2 has completed, the Accompaniment will go directly to the Main section of the opposite Variation (A to B or B to A).
- **Ending section** When the Ending has completed, an Accompaniment will stop.

The above explanation is shown in the diagram below.

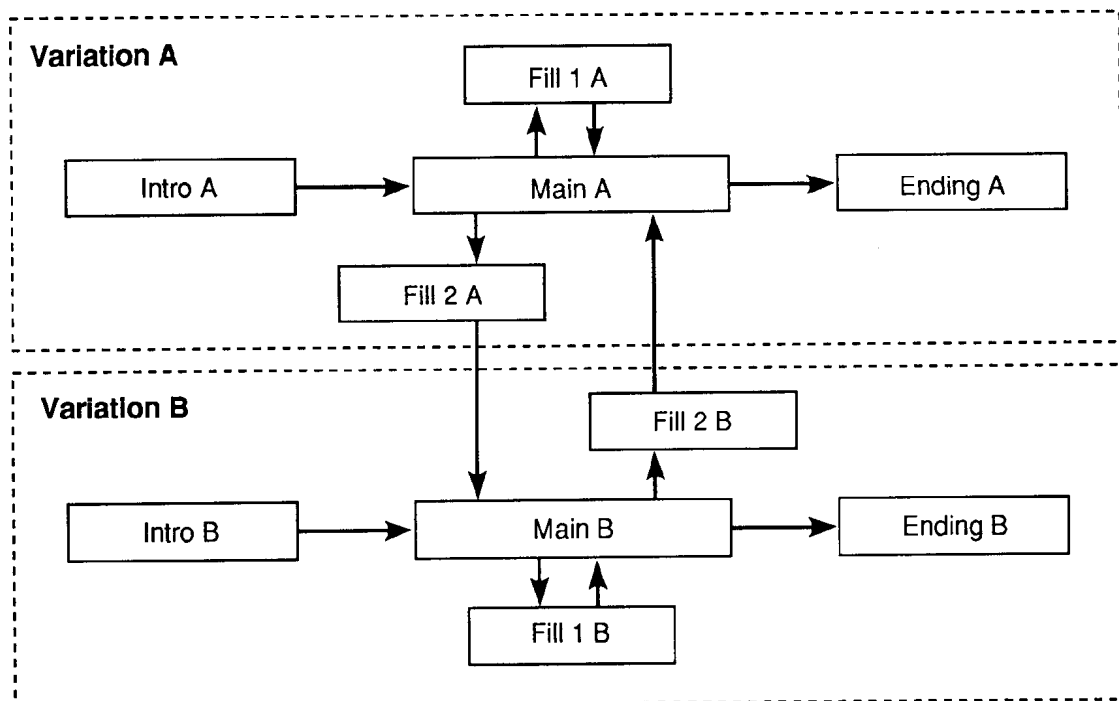

AUTO ACCOMPANIMENT

USING THE AUTO ACCOMPANIMENT

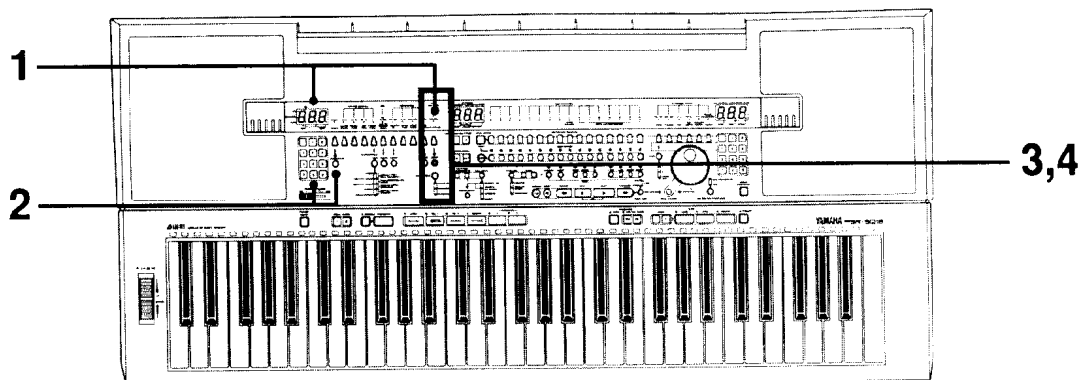

1. Select a Style

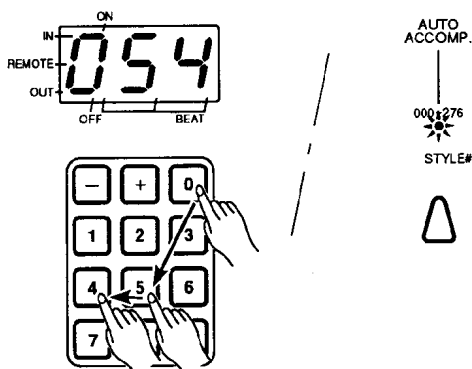

Try selecting style 054 (JAZZ BALLAD).

Press the STYLE # button, and its indicator will light. Select style 054 (JAZZ BALLAD), by using the numeric buttons below the left-hand digital display to input the numbers 0, 5, and 4. The selected style number will appear in the left-hand digital display. Press the + and - buttons below the left-hand digital display to increase or decrease the style number by one. Holding down the + or - button will respectively increase or decrease the style number continuously.

2. Set the Tempo

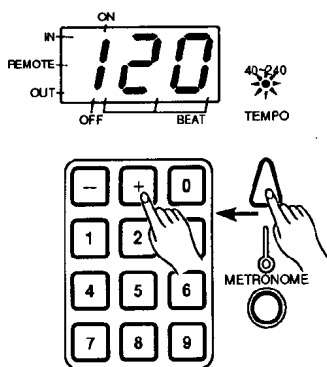

Press the TEMPO button, and its indicator will light. The tempo for the selected style will appear in quarter note beats per minute in the left-hand digital display. Set the tempo to any value between 40 and 280 beats per minute, either before the accompaniment has started or while it is playing, by using the numeric buttons below the left-hand digital display. Press the + and - buttons below the left-hand digital display to increase or decrease the style number by one. Holding down the + or - button will respectively increase or decrease the tempo value continuously.

Press the + and - buttons simultaneously to reset the default tempo of the currently selected style.

* Select a new style while the rhythm is stopped, and the default tempo for the new style is also selected. Selecting a new style while the rhythm plays continues the tempo of the previous style.

3. Setting the AUTO ACCOMPANIMENT ON/OFF

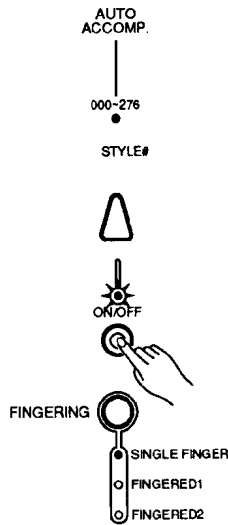

Press the AUTO ACCOMP. ON/OFF button located below the STYLE# button, and its indicator will light.

* For more information regarding ON/OFF settings, refer to page 39.

NOTE: When the indicator of the AUTO ACCOMP. ON/OFF button is not lit, the button is in the OFF position. In this case, rhythm-only Accompaniment is provided.

NOTE: When you turn on Auto Accompaniment, SYNCHRO is automatically on standby status.

4. Setting the Auto Accompaniment Fingering

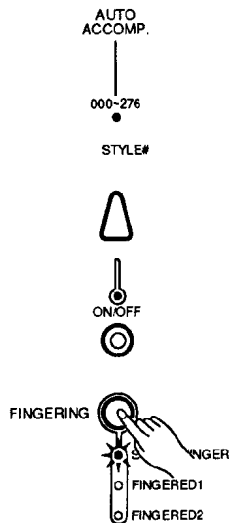

Use the FINGERING button to select a fingering style (Single Finger, Fingered 1, or Fingered 2). The following information describes how to play chords in each Fingering mode.

NOTE: The maximum number of notes that can be played simultaneously is 56. This is reduced when the Auto Accompaniment feature is used. For more information, refer to the "Voice/Polyphony List" in the "List Book".

AUTO ACCOMPANIMENT

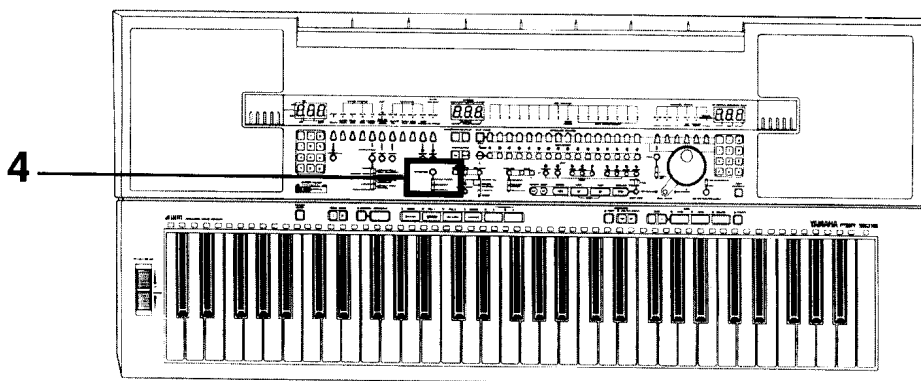

● SINGLE FINGER Mode:

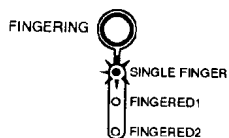

Playing with a maximum of three fingers in the left-hand section of the keyboard (i.e., all keys to the left of and including the split point key) allows you to produce major, minor, 7th, and minor 7th chords. The Accompaniment will play according to the selected style and the chords played.

* In the Single Finger Mode, the split point "default" is set at 49 (C#2). To change the Split Point, refer to page 37.

Single Finger Mode Chord Fingerings

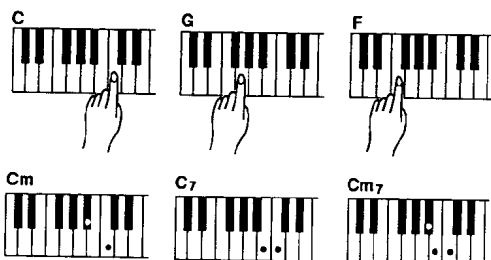

• For a major (M) chord:

Press the root key.

• For a minor (m) chord:

Press the root key and a black key to its left simultaneously.

• For a seventh chord:

Press the root key and a white key to its left simultaneously.

• For a minor-seventh chord:

Press the root key and both a white and a black key to its left simultaneously.

● FINGERED 1 Mode:

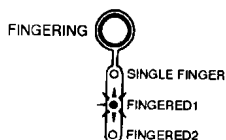

The Fingered 1 Mode is designed for people with prior experience in playing chords. By playing chords in the left-hand section of the keyboard (up to and including the split point), the PSR-SQ16 will play an appropriate accompaniment.

* In the Fingered 1 Mode, the split point "default" is set at 54 (F#2). To change the Split Point, refer to page 37.

The PSR-SQ16 will accept the chords listed on the right in the Fingered 1 Mode.

[Example for "C" chords]

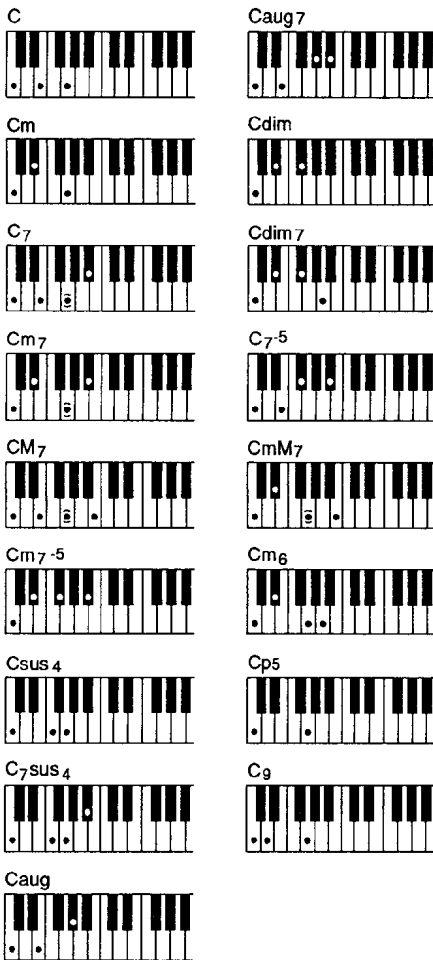

Chord/[Abbreviation]	Normal Voicing
Major [M]	1-3-5
Minor [m]	1-♭3-5
Seventh [7]	1-3-(5)-♭7
Minor seventh [m7]	1-♭3-(5)-♭7
Major seventh [M7]	1-3-(5)-7
Minor seventh flatted fifth [m7-5]	1-♭3-♭5-♭7
Suspended fourth [sus4]	1-4-5
Seventh suspended fourth [7sus4]	1-4-5-♭7
Augmented [aug]	1-3-#5
Augmented seventh [aug7]	1-3-#5-♭7
Diminished [dim]	1-♭3-♭5
Diminished seventh [dim7]	1-♭3-♭5-6
Seventh flatted fifth [7-5]	1-3-♭5-♭7
Minor major seventh [mM7]	1-♭3-(5)-7
Minor sixth [m6]	1-♭3-5-6
Perfect fifth [p5]	1-5
Ninth [9]	1-2-5

* When an octave (the root and the 8th note of its scale) is played, only the root note is produced.

* If a perfect 5th (the root and the 5th note of its scale) is played, only the root and the 5th is produced, so that both major and minor melodies can be played.

* If CHORD CANCEL (any 3 consecutive notes, ex. C, C#, D) is played, accompaniment stops, but the rhythm continues playing.

NOTE: If a chord is inverted (i.e. C E G is played as G C E), the PSR-SQ16 will recognize it as a C chord. However, if Augmented and Diminished 7th chords are inverted, the lowest note will be recognized as the root. Seventh flatted fifth chords may be played with the lowest note as the root or the flatted 7th. Minor sixth chords must be played with the lowest note as the root.

NOTE: Notes in parentheses may be omitted.

● FINGERED 2 Mode:

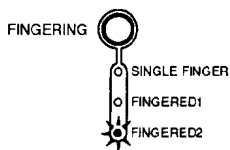

This mode can recognize "on" chords, such as C on E (C/E). In this mode, the lowest note played in the left-hand section of the keyboard will be produced as the bass.

* In the Fingered 2 Mode, the Split point "default" is set at 54 (F#2). To change the Split Point, refer to page 37.

By using "on" chords in the Fingered 2 mode, the bass note of a chord can be changed. For instance, a C chord normally played as C E G will have C in its bass. But if it is played as G C E (C on G, C/E), the PSR-SQ16 will produce a C chord with G in the bass. If the C chord is played as E G C (C on E, C/E), you will hear a C chord with E in the bass.

AUTO ACCOMPANIMENT

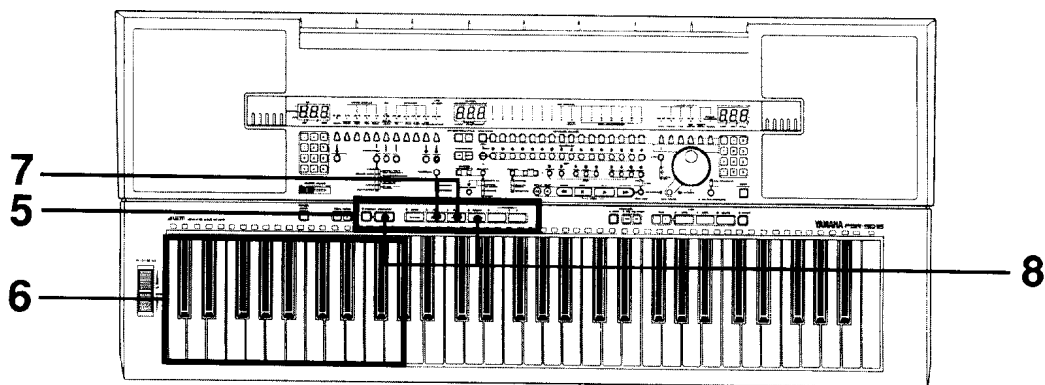

5. Start the Accompaniment

Begin an Accompaniment in one of these three ways.

● Start:

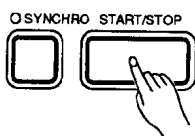

Press the START/STOP button, and the rhythm will immediately begin playing, without the chord accompaniment. As soon as a chord that the PSR-SQ16 "recognizes" is played in the left-hand section of the keyboard, chord accompaniment will begin. If the Auto Accompaniment ON/OFF indicator is not lit, then the PSR/SQ16 will only produce a rhythm accompaniment.

● Synchro start:

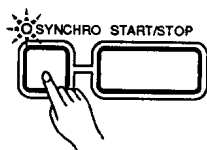

Press the SYNCHRO button, and the indicator above the button will flash. Accompaniment will begin with the first note or chord recognized in the left-hand section of the keyboard. Press the SYNCHRO button again to cancel this mode.

NOTE: If the SYNCHRO button is pressed while the accompaniment plays, the accompaniment stops. Play a note or chord in the left-hand section of the keyboard, and the accompaniment will begin again.

● Synchro start with an introduction:

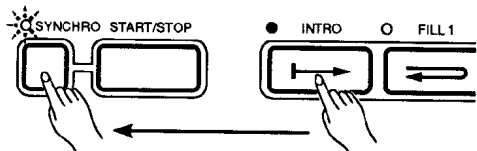

To begin with an introduction, press the INTRO button and then the SYNCHRO button. As soon as a note or chord is played in the left-hand section of the keyboard, the Intro will start. After the Intro has completed, the accompaniment will go directly into the Main section. Press the INTRO button again to cancel this mode and enter the Synchro Start mode.

NOTE: Press the START/STOP button after the INTRO button has been pressed to immediately start the Intro. But only the rhythm will play, until a chord is played in the left-hand section of the keyboard.

■ About the Full Accompaniment Variations

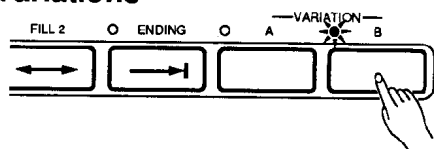

All Full Accompaniment (#000-099) styles are provided with A and B variations. To choose a variation, press the VARIATION A or VARIATION B button. (Variations do not apply when using Part Accompaniments (#100-199) or Rhythm Styles (#200-268).

■ About the Beat Display

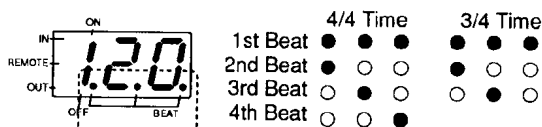

The three LED dots of the left-hand digital display provide a visual indication of the beats as shown in the diagram on the left.

6. Let's play

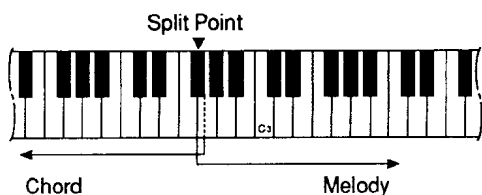

Play a chord or notes in the left-hand section of the keyboard, in the selected fingering style (SINGLE FINGER, FINGERED 1, FINGERED 2), and an accompaniment corresponding to the chord will be produced. Then, play the melody in the right-hand section of the keyboard.

7. Use Fill-Ins.

● Fill 1 section

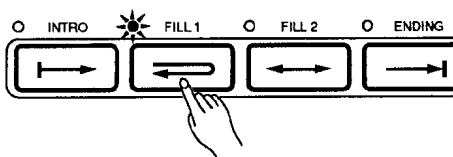

● Fill 2 section

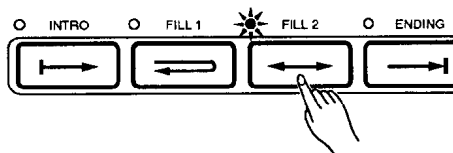

Two types of fill-in sections can be used with Full Accompaniment. The fill-in section starts immediately when the FILL 1 or FILL 2 button is pressed, and plays to the end of that measure.

Fill 1 has A and B Variations. Press the FILL 1 button to produce a fill, and the accompaniment returns to the main section of the same variation.

MAIN A → FILL 1 A → MAIN A
MAIN B → FILL 1 B → MAIN B

FILL 2 also has A and B Variations. Press the FILL 2 button to produce a fill, and the accompaniment goes to the main section of the opposite variation.

MAIN A → FILL 2 A → MAIN B
MAIN B → FILL 2 B → MAIN A

- * If the FILL 1 or 2 button is pressed after the first beat of the last measure, the fill will start from the beginning of the next measure.
- * If the FILL 1 or 2 button is pressed while the Intro is playing, the fill will play immediately, and the accompaniment will go directly to the Main section.
- * If the FILL 1 or 2 button is pressed while an Ending plays, the fill will play. The accompaniment will then go directly to the Main section, and the rhythm accompaniment will not stop.
- * For a flow chart regarding relationships of FILL in sections to Accompaniment sections, refer to page 17.

8. Stop the Accompaniment

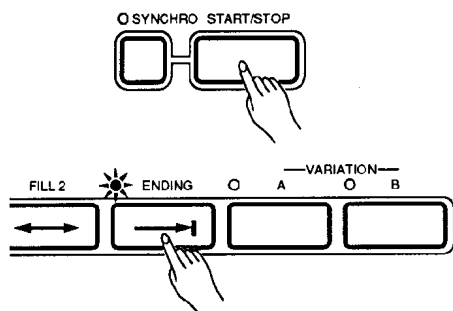

The accompaniment can be stopped by pressing the START/STOP button at anytime. The accompaniment can also be stopped by playing an Ending section. Press the ENDING button, and the ending section will start from the next measure. When the ending section has completed, the rhythm will stop.

- * Rhythm can start from either the A or B Variations of the Intro, Main, Fill 1, Fill 2 or Ending sections. Press the appropriate button before starting.
- * To select the Main section, turn off all section indicators (INTRO, FILL 1 and 2, ENDING)
- * The Intro section can be played at any time by pressing the INTRO button. The Intro section will begin from the next measure. When the Intro has completed, the accompaniment will go directly to the Main section.
- * INTRO, FILL 1, FILL 2, VARIATION A, VARIATION B, ENDING, SYNCHRO, and START/STOP functions can all be assigned to an optional foot switch. Refer to the PEDAL ASSIGN section on page 64.



PLAYING THE DEMONSTRATION SONG

To demonstrate its capabilities, the PSR-SQ16 includes 1 internal demonstration song, and a Demo Disk that contains 9 demo songs. (One of the disk demo songs is the same as the internal demo song.) To hear these songs, follow the procedures below.

PLAYING THE INTERNAL DEMONSTRATION SONG

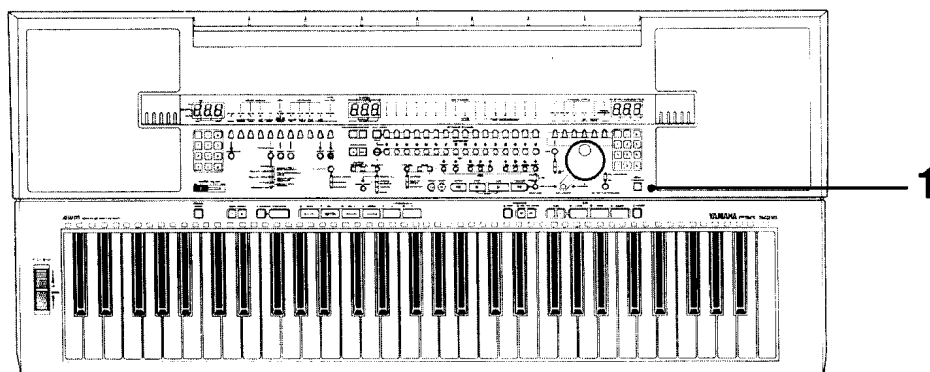

1. START/STOP the demo song



To start the demo song, press the DEMO START/STOP button once. The demo song will play repeatedly. Press the DEMO START/STOP button again to stop play.

DISK DEMONSTRATION SONGS

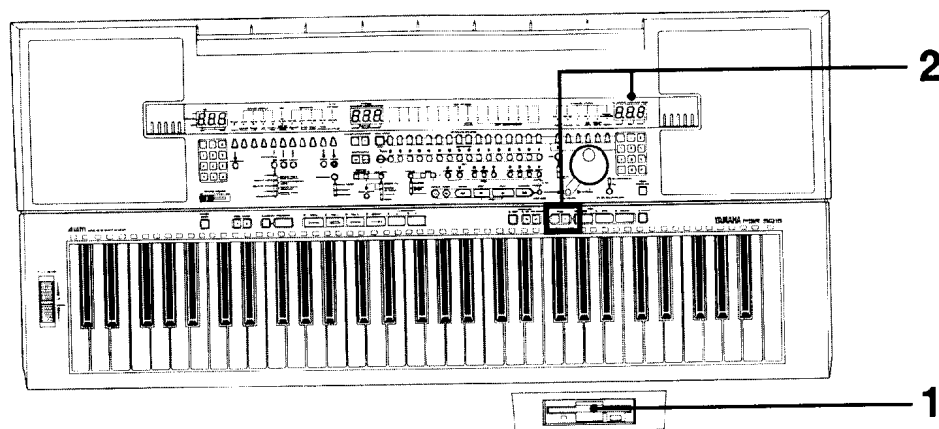

1. Insert the Demo Disk

With the label facing upwards, insert the disk into the PSR-SQ16's disk drive slot, as shown in the illustration on the left.

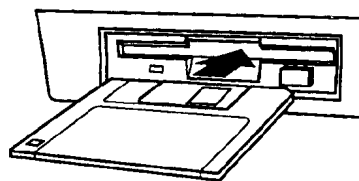

2. Select a Demo Song (File) from the disk

Use the FILE# + or - button to select a song file. Pressing the FILE# + or - button changes the disk demo song file number shown in the right-digital display. Select a file containing data, which will have a number preceded by an "F" (for example, F01).

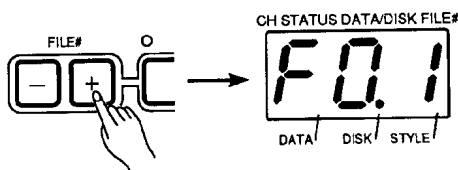

* File number 01 is the same song data as the internal demonstration song.

NOTE: If there is no data in the disk file selected, "-" will appear on the display before the number (for example, -12). If you try to load such a file into the PSR-SQ16's memory, a "disk error" message (dE2) will appear on the display. If an error message appears, refer to the "Error Message" section on page 74.

PLAYING THE DEMONSTRATION SONG

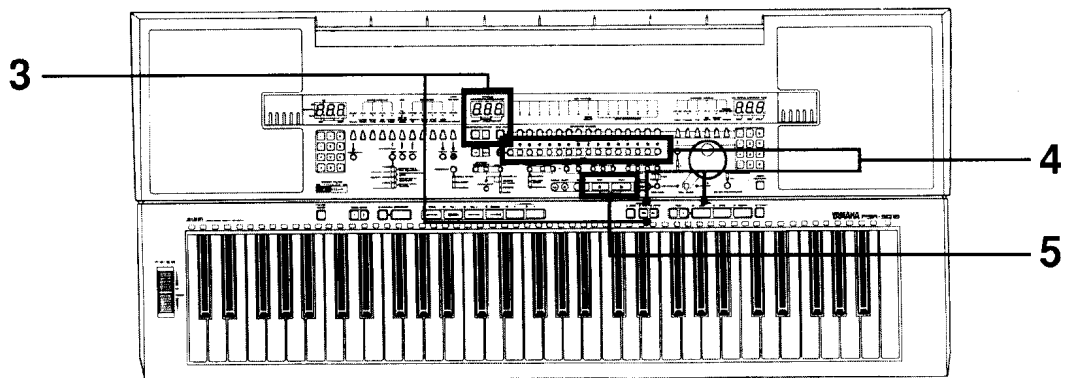

3. Select the song file number to load a demo song

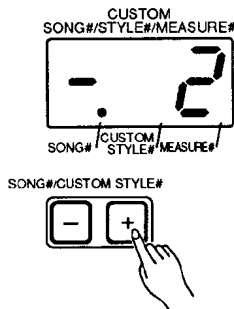

Use the SONG#/CUSTOM STYLE# +/- buttons to select a Song into which the demo song data may be loaded. Select an empty Song number from 1 through 8. "F" appears before file numbers that contain data, while "-" appears before file numbers that do not contain data. After selecting a Song number, the ARE YOU SURE? indicator will flash. Press the YES button to set the Song number you've selected. If there is no data in the sequencer, any Song number may be used.

4. LOAD the song data

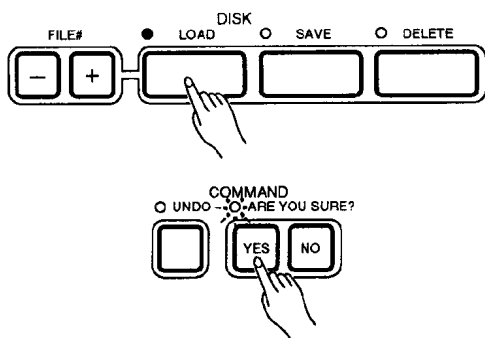

Press the LOAD button, and the ARE YOU SURE? indicator will flash. Check that the Song number in the center digital display, and the disk file number in the right-hand digital display are correct. Press the YES button to begin loading.

When loading is completed, the lit indicators of KEYBOARD CHANNELS 1 through 16 will show which tracks are used for the demo song.



NOTE: When data is being loaded, the LOAD indicator will light, and the DISK IN USE indicator will flash. Never remove the disk from the disk drive in this situation, or data may be destroyed. Also during the loading procedure, the keyboard will not produce any sound.

NOTE: Loading data into a song number will erase any data stored in that song number. If you want to keep this data, save it to a separate floppy disk before loading new data. (Refer to page 70)

5. START/STOP of the disk demo song

Pressing the sequencer PLAY button will start playback of the demo song. Pressing the STOP button will stop playback. Remaining button functions are described in the SEQUENCER section on page 46.

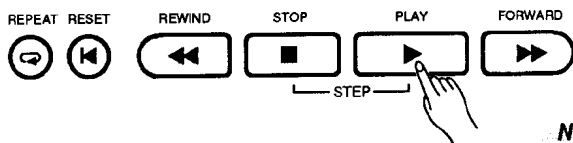

NOTE: When loading another demo song, select another song number before loading. In this way, a new demo song can be loaded without erasing previous song data. Depending on the amount of memory each song requires, 3 to 5 demo songs can be separately loaded into the PSR-SQ16's memory at one time.

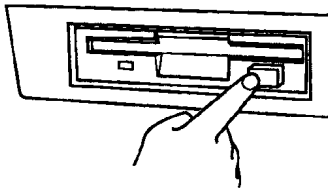

- To eject the floppy disk, press the eject button slowly and completely. Remove the disk by hand only after it is fully ejected.

HINT

Listening to disk demo songs track by track

The indicators of SEQUENCER tracks which contain data will be lit. Pressing the SEQUENCER button below an indicator will turn a track on or off (a lit indicator means that the track is on). To understand how song tracks are put together, try listening to each track separately.

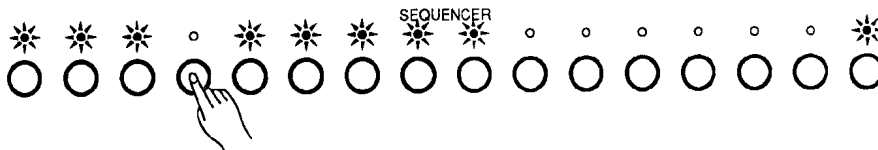

The SOLO function

If you wish to hear only one track, the other tracks can be muted by using the SOLO function.

- **Procedure:** During playback of the demo song, hold the SPLIT ASSIGN/SOLO button, then the SEQUENCER track button that you want to hear. All other sequencer tracks will be muted and only the selected track will be heard for as long as the buttons are held down. Release the buttons and all tracks will be heard again.

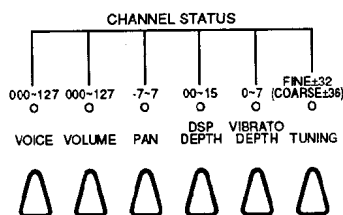
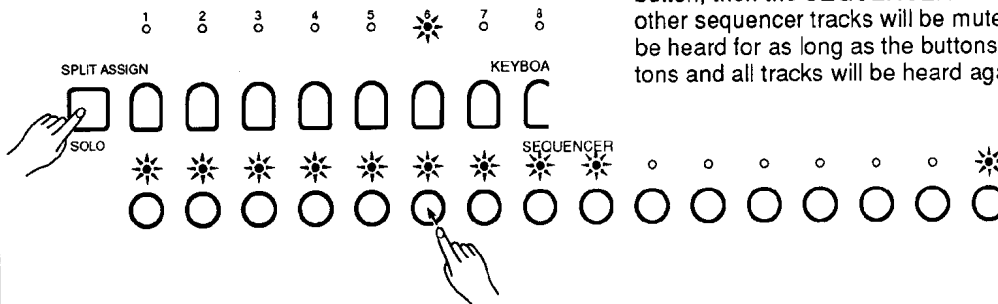

Use the SOLO function to help you understand what kind of voice settings (VOICE, VOLUME, PAN, DSP DEPTH, etc.) are recorded to each Channel. Use this knowledge in your own playing or recording.

NOTE: If all sequencer tracks have been turned off, playback of a song is impossible.



PSR-SQ16 SYSTEM CHART

The PSR-SQ16 is a multi-functioning keyboard. It comes equipped with a Master Keyboard, Auto Accompaniment, a Sequencer, and a Tone Generator Unit. Each of these functions resides in a "module" within the PSR-SQ16. These modules communicate internally through a MIDI line (MIDI BUS). The system chart below shows the flow of MIDI data in relation to the PSR-SQ16's panel controls. Study this chart to get a general understanding of the PSR-SQ16, then read the Advanced Features section for detailed information regarding each function.

- Modules **1** through **10** below correspond to the areas designated **1** through **10** on the PSR-SQ16 panel display in the top right of page 29. This Advanced Features section provides greater details on each of these settings.
 - MIDI system data flow is indicated by arrows.
- NOTE:** Data received through the MIDI IN connector does not exit via the MIDI OUT connector. Use the MIDI THRU connector to re-transmit data received by the MIDI IN connector. The MIDI OUT connector sends sequencer data to external devices.

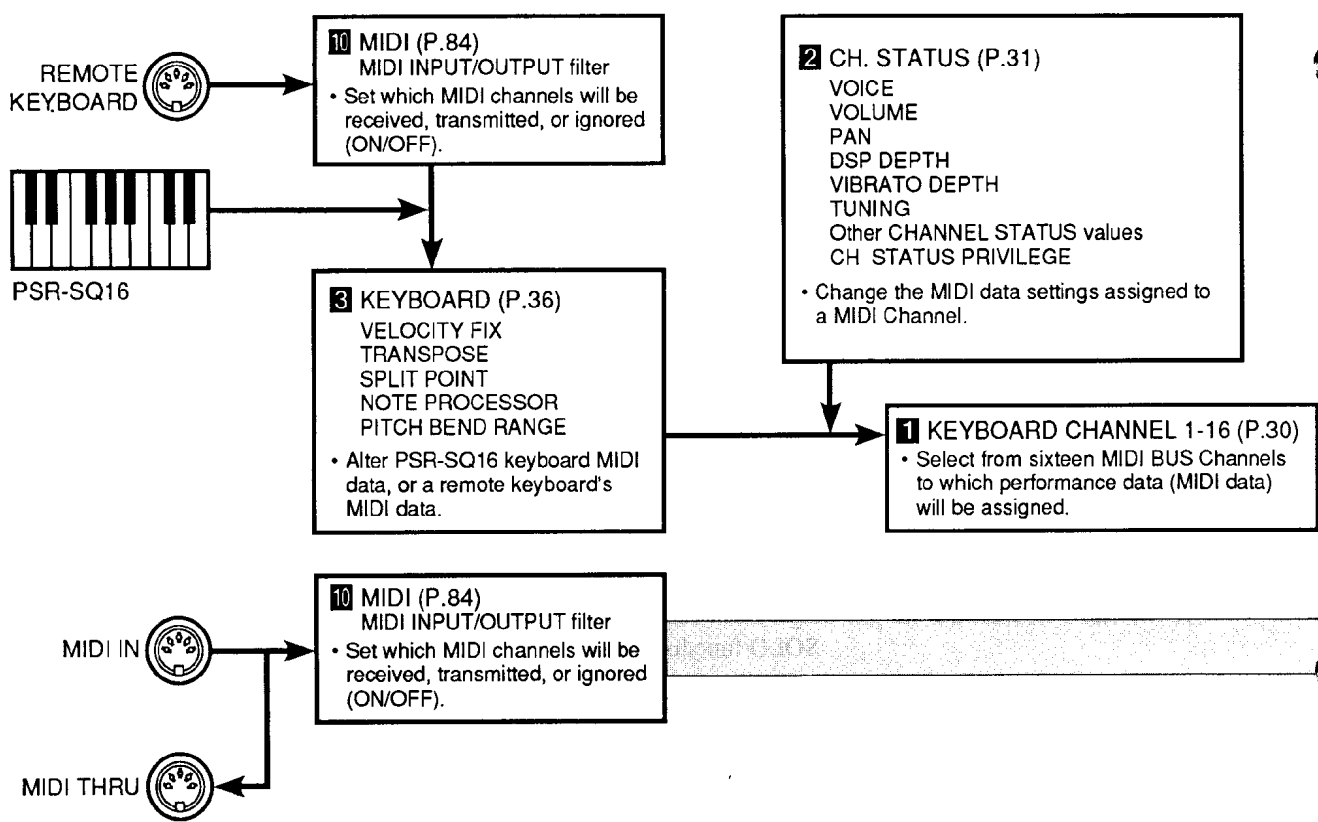

Ex. 1 through 6 show which functions are used for specific operations and

Ex. 1 Performing on the PSR-SQ16 keyboard.

- 1** KEYBOARD CHANNEL (P.30)
- 2** CH. STATUS module (P.31)
- 3** KEYBOARD module (P.36)
- 4** AUTO ACCOMPANIMENT module (P.39)
- 9** SOUND MODULE (P.76)

Ex. 2 Controlling the PSR-SQ16 through an external keyboard.

- 10** MIDI INPUT/OUTPUT filter (P.84)
- 1** KEYBOARD CHANNEL (P.30)
- 2** CH. STATUS module (P.31)
- 3** KEYBOARD module (P.36)
- 4** AUTO ACCOMPANIMENT module (P.39)
- 9** SOUND MODULE (P.76)

Ex. 3 Using the PSR-SQ16 Sequencer to Play, Record, or Edit data.

- 1** KEYBOARD CHANNEL (P.30)
- 2** CH. STATUS module (P.31)
- 3** KEYBOARD module (P.36)
- 4** AUTO ACCOMPANIMENT module (P.39)
- 5** SEQUENCER module (P.42)
- 9** SOUND MODULE (P.76)

PSR-SQ16 STRUCTURE

- 1** KEYBOARD CHANNEL
- 2** CH. STATUS
- 3** KEYBOARD
- 4** AUTO ACCOMPANIMENT
- 5** SEQUENCER
- 6** PEDAL ASSIGN
- 7** TEMPO
- 8** DISK
- 9** SOUND MODULE
- 10** MIDI INPUT/OUTPUT filter

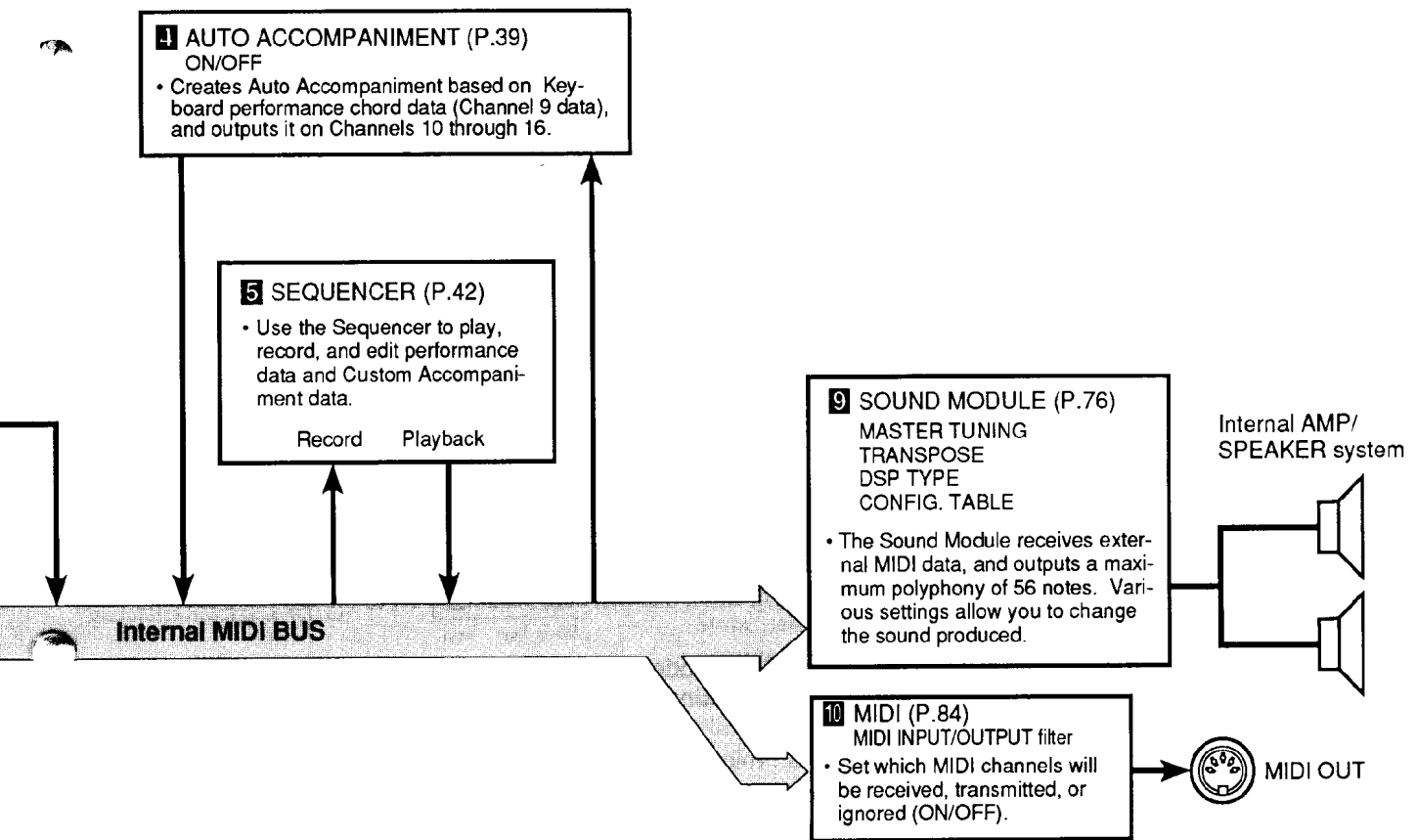
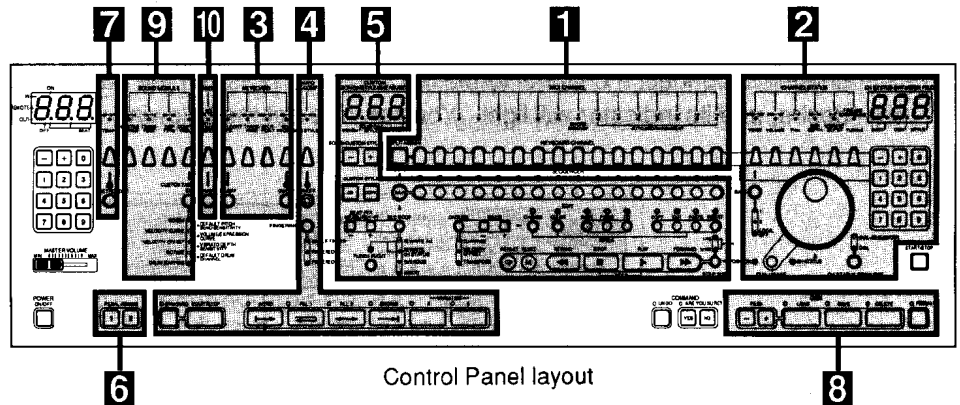

on which page detailed information can be found for each function.

Ex. 4 Using the PSR-SQ16 Sequencer to Play, Record, or Edit received data.

- 10** MIDI INPUT/OUTPUT filter (P.84)
- 5** SEQUENCER module (P.42)
- 9** SOUND MODULE (P.76)

Ex. 5 Controlling an external MIDI device by playing the PSR-SQ16's keyboard.

- 1** KEYBOARD CHANNEL (P.30)
- 2** CH. STATUS module (P.31)
- 3** KEYBOARD module (P.36)
- 10** MIDI INPUT/OUTPUT filter (P.84)

Ex. 6 Receiving data from an external Sequencer, then using the PSR-SQ16 as a tone generator.

- 10** MIDI INPUT/OUTPUT filter (P.84)
- 9** SOUND MODULE (P.76)

KEYBOARD CHANNEL

Use KEYBOARD CHANNEL to assign performance data and CHANNEL STATUS settings to a MIDI channel. Connect a channel to the MIDI BUS by pressing the button of the KEYBOARD CHANNEL you desire, and its indicator will light. You can also set the following with KEYBOARD CHANNEL.

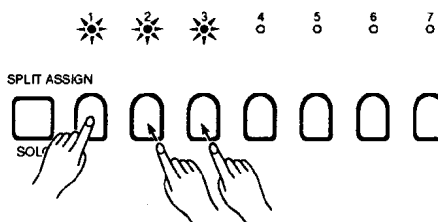
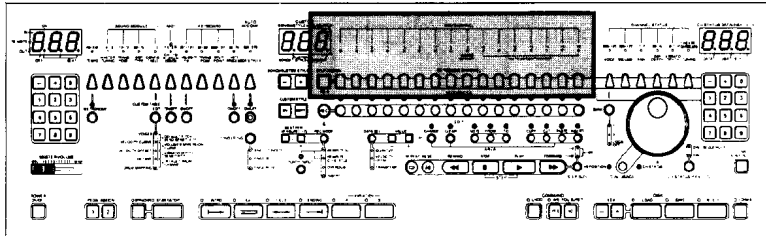

- You can assign performance data generated on the keyboard to several channels simultaneously. This allows you to send the same data to every channel selected.

⇨ Hold down the KEYBOARD CHANNEL that is already ON (its indicator is lit), then press the buttons of any other KEYBOARD CHANNELS you want to select. Any number of KEYBOARD CHANNELS can be ON at one time.

NOTE: When two or more KEYBOARD CHANNELS are ON, pressing any other KEYBOARD CHANNEL activates that channel only, and any previously activated channels will be turned OFF.

NOTE: When multiple keyboard channels which are set to the same voice and same pitch are played back simultaneously, sound interference may alter the voice.

- The PSR-SQ16 allows you to “split” the keyboard and play two voices at once—one with the left hand and one with the right hand.

⇨ Set the right-hand voice (KEYBOARD CHANNEL) as described above. To set the left-hand voice, hold down the SPLIT ASSIGN button, then press any KEYBOARD CHANNEL button. The indicator of the channel you've selected will flash, and that channel is then set to the left-hand section.

- When in the Split mode, you can “layer” the left-hand section of the keyboard by selecting two or more KEYBOARD CHANNELS at one time.

⇨ To “layer” voices, holding down the button of the KEYBOARD CHANNEL assigned to the left-hand section, press any other KEYBOARD CHANNEL buttons. Use this procedure to layer as many voices as you wish.

NOTE: To exit the Split mode, hold down the SPLIT ASSIGN button and press the KEYBOARD CHANNEL button that is assigned to the left-hand section, and its indicator will go out.

When multiple channels are assigned to the left-hand section of a Split keyboard, hold down the SPLIT ASSIGN button and press the button of any KEYBOARD CHANNEL assigned to the left-hand section, and only that channel will be assigned to the left-hand section. Then perform the Split mode exit operation again.

NOTE: KEYBOARD CHANNELS assigned to the right-hand section cannot be assigned to the left-hand section, and vice versa.

NOTE: When the Auto Accompaniment is activated, Channel 10 through 16 will be automatically set for the Auto Accompaniment parts (Refer to Page 39)

NOTE: A MIDI channel's indicator flashes when that channel is played on the keyboard, when that channel is used in sequencer or accompaniment playback, or when MIDI IN data is received from an external device.

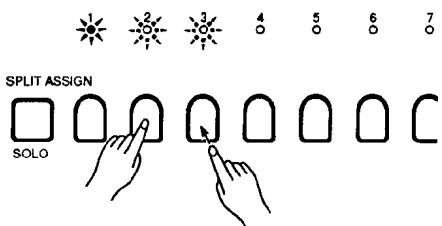
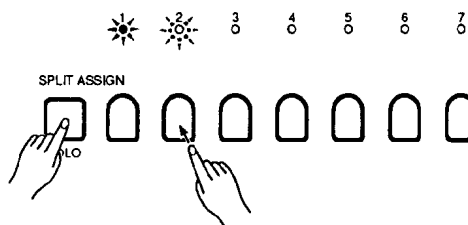

CHANNEL STATUS consists of several different sound-altering parameters (MIDI program change, control changes) that affect the KEYBOARD CHANNELS (Section 1). CHANNEL STATUS parameters are retained within each KEYBOARD CHANNEL, so selecting a new CHANNEL recalls the parameters for that CHANNEL.

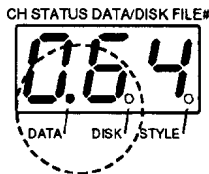
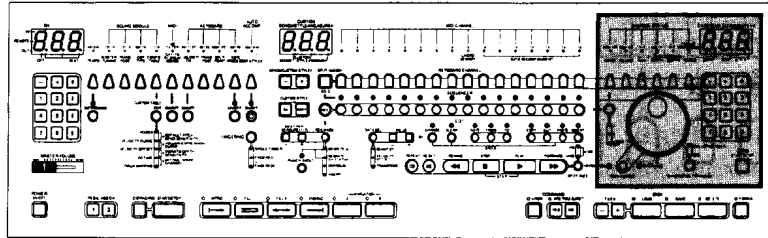

Channel Status data is shown in the right-hand digital display. This display also shows Disk File Numbers (refer to page 70). Which information is currently displayed is indicated by “dots” on the lower portion of the right-hand digital display. If the Data “dot” is lit, then CHANNEL STATUS information is currently displayed, and if the Disk “dot” is lit, then Disk File numbers are currently displayed. Channel Status Sustain and Expression are controlled with the FOOT PEDAL, and Pitch Bend is controlled with the Pitch Bend wheel. Pitch Bend Sensitivity can be adjusted when the wheel is turned fully UP or DOWN. The Sustain, Expression, and Pitch Bend values are not shown on the display.

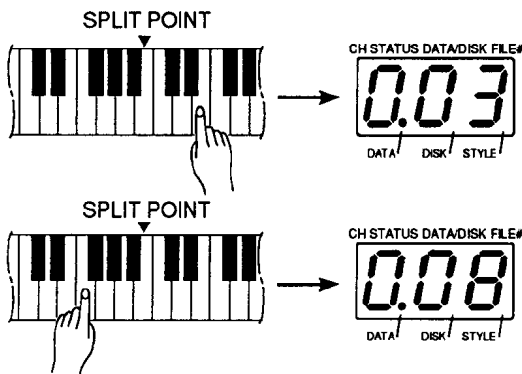

● When the keyboard is in the “Split Voice Mode”.

By depressing in the right-hand section of the keyboard, the right-hand section’s Channel Status settings will be shown in the right-hand digital display. It is then possible to change right-hand section Channel Status settings. Display and change left-hand section Channel Status settings in the same manner.

Pitch Bend, Sustain On/Off, and Expression are simultaneously applied to both the right-hand and left-hand sections.

2. CHANNEL STATUS

CH STATUS DATA/DISK FILE*

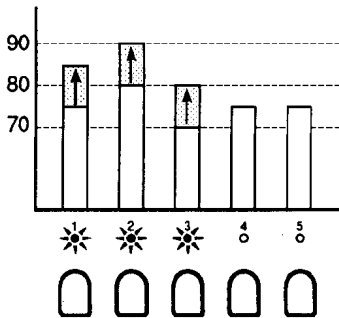
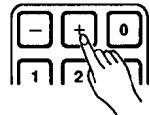
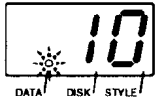

* When the changes to the Channel status settings are made as GROUP, the dot for DATA below the right display will flash.

● Group

You can change the Channel Status settings of two or more Channels simultaneously. This is done by entering the amount of change you desire using the DIAL or numeric buttons located below the right-hand digital display.

For example, let's say Channel 1 (set to VOLUME 90) and Channel 5 (set to VOLUME 65) are currently selected. (the right-hand digital display resets to 000 when two or more channels are selected.) If you then select the VOLUME setting of Channel Status (make sure that VOLUME indicator is lit), you will be able to alter the VOLUME setting of both Channel 1 and Channel 5. Let's say you enter an adjustment amount of 10 (this amount will appear in the right-hand digital display). Channel 1 will then change from VOLUME 90 to VOLUME 100, and Channel 5 will change from VOLUME 65 to VOLUME 75. Make changes in this way for each Channel Status setting. When in the GROUP mode, Channel Status settings can be adjusted in either positive or negative amounts, so data numbers have been doubled as follows:

VOICE: -127 to 127, VOLUME: -127 to 127, PAN: -14 to 14,
 DSP DEPTH: -15 to 15, VIBRATO DEPTH: -7 to 7,
 TUNING: -64 to 64 (Fine Tuning) and -72 to 72 (Coarse Tuning)

NOTE: In the GROUP mode, inputting a Channel Status setting amount that exceeds the allowable value can not be accepted. For example, if a Channel is assigned a VOLUME value of 120, and you enter a change amount of 30, the maximum VOLUME setting of 127 will be assigned to that Channel.

NOTE: In the Group mode, setting the input value to "000" returns all Channels to the values before Group changes, and the relationship between Channels will never change.

NOTE: During Group operation, if a Channel Status setting changes due to sequencer playback or data from MIDI IN connector, the Channel Status setting returns to "000", and a new relationship is set.

NOTE: In the Group mode, if any Channel Status change is input from a Remote Keyboard terminal, all the Channels in the group will be set to the value input from the external device.

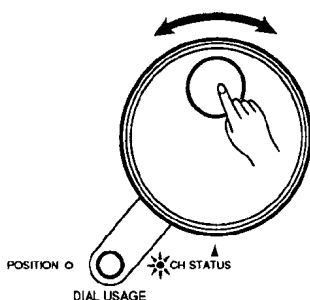

DIAL Usage

All Channel Status data can be set using the DIAL. Press the DIAL USAGE button and the CH STATUS indicator to the right of the DIAL USAGE button will light, and the DIAL may be used. Turning the DIAL to the right increases Channel Status data values and turning to the left decreases Channel Status data values.

● **VOICE Select (VOICE [BANK 1, BANK 2, LOCAL OFF])**

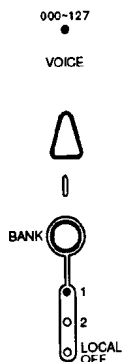

Refer to the List Book which comes with the PSR-SQ16 when selecting Voices. Before you can input the Voice number you've selected, you need to select the proper BANK (BANK 1, BANK 2, or LOCAL OFF) by using the BANK button. Once the proper Bank is selected, you can input the Voice number you've selected using the DIAL or the numeric buttons located below the right-hand digital display. The PSR-SQ16 has 200 Voices (although Bank 1 and Bank 2 each have 127 Voice numbers), and the voice numbers cycle in this way: 126→127→000→001→ 002 or 002→ 001→ 000→127→126.

BANK 1, BANK 2, LOCAL OFF.....BANK 1 and BANK 2 correspond to internal tone generators 1 and 2, and each generator's maximum polyphony is 28 notes. The Voice you desire determines which Bank you choose. LOCAL OFF is for selecting an external tone generator connected to the MIDI connector. The PSR-SQ16 will not generate any sound in the LOCAL OFF mode. Also in the LOCAL OFF mode, any Keyboard Channel selected is transmitted via the MIDI OUT connector. When BANK 1 or BANK 2 is selected, the I/O FILTER function can be used to determine which Channels will be transmitted via the MIDI OUT connector.

*NOTE: A new VOICE setting takes effect with the first note you play on the keyboard.
* Please refer to the List Book for the default setting.*

● **VOLUME**



VOLUME adjusts the sound volume of the selected KEYBOARD CHANNEL. Press the VOLUME button and its indicator will light. Then set the value between 000 (minimum) and 127 (maximum) using the DIAL or the numeric buttons located below the right-hand digital display. Data values 000 through 127 also serve as MIDI data values.

** Please refer to the List Book for the default setting.*

● **PAN**



PAN alters the left or right position of the selected KEYBOARD CHANNEL within the stereo sound field. Press the PAN button and its indicator will light. Use the DIAL or the numeric buttons located below the right-hand digital display to set the value between -7 (full left sound) and 7 (full right sound), with 0 as the center position (sound is equally distributed between the left and right speakers).

*NOTE: A new PAN setting takes effect with the first note you play on the keyboard.
* Please refer to the List Book for the default setting.*

● **DSP DEPTH**

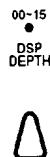

DSP DEPTH alters the sound depth perception of the DSP type selected in the SOUND MODULE for a currently selected KEYBOARD CHANNEL. Press the DSP DEPTH button and its indicator will light. Set the value between 00 (minimum, a Voice will sound near) and 15 (maximum, a Voice will sound far) using the DIAL or the numeric buttons located below the right-hand digital display.

*NOTE: A new DSP DEPTH setting takes effect with the first note you play on the keyboard.
* Please refer to the List Book for the default setting.*

● **VIBRATO DEPTH**



VIBRATO DEPTH alters the sound vibration of the selected KEYBOARD CHANNEL. Press the VIBRATO DEPTH button and its indicator will light. Set the value between 0 (minimal sound vibration) and 7 (maximum sound vibration) using the DIAL or the numeric buttons located below the right-hand digital display.

*NOTE: The default Vibrato Depth for all voices is the optimum Vibrato Depth level, tailored specifically for each individual voice.
* Please refer to the List Book for the default setting.*

2. CHANNEL STATUS

● TUNING

-32~32
●
TUNING



TUNING adjusts the pitch of the selected KEYBOARD CHANNEL. There are two TUNING methods.

- **FINE TUNING**.....Fine Tune a KEYBOARD CHANNEL by pressing the TUNING button once, and its indicator will light. The FINE TUNING function allows tuning within a two semitone range (1 semitone equals 100 cents). Each increment of adjustment equals approximately 3 cents. Fine Tune the selected KEYBOARD CHANNEL to any value between -32 (the pitch becomes flatter) and 32 (the pitch becomes sharper). Use the DIAL, or the +/- buttons or numeric buttons located below the right-hand digital display, to set the desired value. The default FINE TUNING setting is 00 (A3=440 Hz).
- **COARSE TUNING**.....Coarse Tune a KEYBOARD CHANNEL by pressing the TUNING button twice quickly, and its indicator will light. The COARSE TUNING function allows tuning over a six octave range (1 octave = 12 semitones). Each increment of adjustment equals one semitone. Coarse Tune the selected KEYBOARD CHANNEL to any value between -36 (the pitch becomes flatter) and 36 (the pitch becomes sharper). Use the DIAL, or the +/- buttons or numeric buttons located below the right display, to set the desired value. The default setting is 00 (A3 = 440 Hz).

* The VOICE, VOLUME, PAN, DSP DEPTH, VIBRATO DEPTH, and TUNING functions can be assigned to the FOOT PEDAL. For more information, refer to the PEDAL ASSIGN section on page 64.

* Voice Nos. 065~087 (Percussion Voices) do not accept COARSE TUNING.

■ Other CHANNEL STATUS values

● SUSTAIN ON/OFF



SUSTAIN ON/OFF can be applied to the currently selected KEYBOARD CHANNEL. The Sustain value is not displayed, but it ranges internally from a value of 0 through 127. SUSTAIN ON/OFF is operated by the FOOT SWITCH. For more information, refer to "Rewrite Channel Status" on page 48 and "Pedal Assign" on page 64. The default SUSTAIN setting is 0.

● EXPRESSION

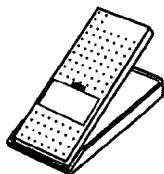

EXPRESSION can be adjusted for the currently selected KEYBOARD CHANNEL. The Expression value is not displayed, but it ranges internally from a value of 0 through 127. EXPRESSION is operated by the FOOT CONTROLLER. For more information, refer to "Rewrite Channel Status" on page 48 and "Pedal Assign" on page 64. The default EXPRESSION setting is 127.

● PITCH BEND

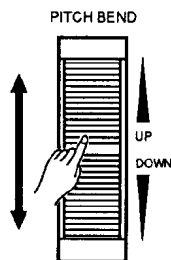

PITCH BEND effect can be adjusted for the currently selected KEYBOARD CHANNEL (sound generated on the keyboard can be bent up or down). The Pitch bend value is not displayed, but it ranges internally from a value of 0 through 127. PITCH BEND is operated with the Pitch Bend wheel. Set the maximum pitch bend range by referring to "Pitch Bend Range" on page 38. The default PITCH BEND setting is 64 (center).

● PITCH BEND SENSITIVITY

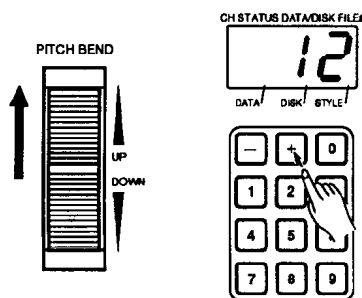

Value	Range 00.00 ~ 127.127
0	0 ~ 0
1	-1 ~ 1
2	-2 ~ 2
3	-3 ~ 3
4	-4 ~ 4
5	-5 ~ 5
6	-6 ~ 6
7	-7 ~ 7
8	-8 ~ 8
9	-9 ~ 9
10	-10 ~ 10
11	-11 ~ 11
12	-12 ~ 12

PITCH BEND SENSITIVITY adjusts the pitch bend sensitivity of the currently selected KEYBOARD CHANNEL when receiving MIDI data. Roll the Pitch Bend wheel completely up or down, and the currently set sensitivity value appears in the right-hand digital display. Use the DIAL, the +/- buttons or numeric buttons below the right-hand digital display to set a Pitch Bend Sensitivity value range between 0 and 12. The default Pitch Bend Sensitivity setting is 12.

* PITCH BEND RANGE (refer to page 38) and PITCH BEND SENSITIVITY values that result in the same product will produce the same PITCH BEND effect.

For example, a PITCH BEND RANGE of 2 and a PITCH BEND SENSITIVITY of 12 ($2 \times 12 = 24$) will produce the same Pitch Bend effect as a PITCH BEND RANGE of 4 and a PITCH BEND SENSITIVITY of 6 ($4 \times 6 = 24$).

* This Pitch Bend Sensitivity affects the sensitivity of received MIDI Pitch Bend data.

* It is possible to change this Pitch Bend Sensitivity setting by using external equipment to transmit Pitch Bend Sensitivity data to the PSR-SQ16.

NOTE: The Pitch Bend Sensitivity amount appears on the right-hand digital display, while the Pitch Bend Range simultaneously appears on the left-hand digital display. This indicates the PSR-SQ16's Pitch Bend data output width, which is used as KEYBOARD data. Refer to "Pitch Bend Range (for transmission)" on page 38 for details.

* For Channel Status settings, simultaneously press the +/- buttons below the right-hand digital display to return to the default value. (except for Sustain, Expression, and Pitch Bend)

* Please refer to the List Book for the relation between each Channel Status, and MIDI program and control change data.

DIAL

● Setting the Channel Status Privilege CH STATUS PRIVILEGE

When changing a Keyboard Channel's Channel Status settings, CH STATUS PRIVILEGE determines whether Channel Status data from the Sequencer will be accepted or not. Pressing the CH STATUS PRIVILEGE button alternates between the modes DIAL + SEQUENCER and DIAL. The corresponding indicator will show which mode is active.

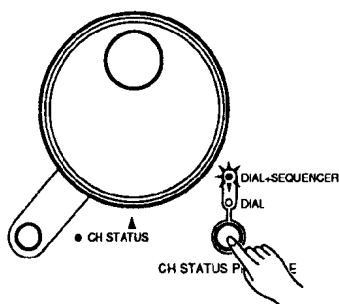

• DIAL + SEQUENCER

In this mode, any CHANNEL STATUS changes made with the DIAL, right-hand numeric buttons, Foot Switch, Foot Controller, or Pitch Bend wheel, along with data from the Sequencer, will affect KEYBOARD CHANNEL data. The last value set will take effect.

• DIAL

In this mode, only CHANNEL STATUS changes made with the DIAL, right-hand numeric buttons, Foot Switch, Foot Controller, or Pitch Bend wheel are accepted, while changes from the Sequencer are ignored. This mode is useful for trying alternate voices or volume levels while listening to Sequencer playback. In addition, use this mode for rehearsal, before executing Rewrite Channel Status (refer to page 48).

When in the DIAL mode, change Channel Status Pitch Bend, Sustain, or Expression by respectively using the wheel, foot switch, or foot controller. The last change made for each Channel Status will be set as its new value, and "Pbd", "SUS", or "EPS" will appear in the right-hand digital display.

* The default setting is DIAL + SEQUENCER.

3 KEYBOARD

You can alter the sounds produced with the keyboard using the KEYBOARD settings. KEYBOARD settings simultaneously affect every KEYBOARD CHANNEL, unlike the CHANNEL STATUS settings which affect only individual Channels. Switching KEYBOARD CHANNELS does not affect KEYBOARD settings.

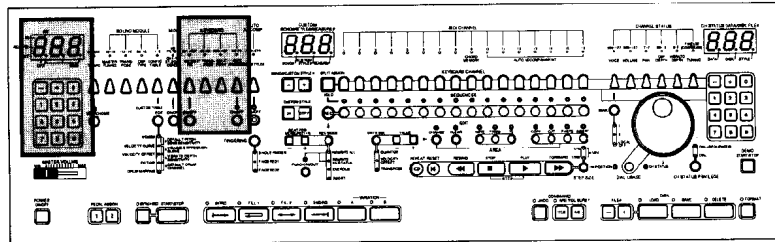

● VELOCITY FIX

001-127
●
VELOCITY
FX



ON/OFF



VELOCITY FIX sets data from the keyboard at a fixed velocity amount. Press the VELOCITY FIX button and its indicator will light. Set the Velocity Fix to a value between 001 and 127 by using the +/- buttons or numeric buttons located below the left-hand digital display (data values correspond to MIDI data numbers). Activate the VELOCITY FIX by pressing the VELOCITY FIX ON/OFF button below the VELOCITY FIX button.

When the VELOCITY FIX mode is activated, data from the keyboard will always be at the set velocity amount, regardless of how hard or soft you play.

- * Data received from a REMOTE KEYBOARD will also be affected by the VELOCITY FIX function.
- * The default setting is 110. Press the +/- buttons simultaneously to set the Velocity Fix value to 110.

NOTE: When in the Split Voice mode, adjust the Velocity Fix of the left-hand section of the keyboard by pressing any key in the left-hand section, and adjust the Velocity Fix of the right-hand section by pressing any key in the right-hand section.

● TRANSPOSE

-36-36
●
TRANS-
POSE



The TRANSPOSE function changes the notes assigned to the keys of the PSR-SQ16 keyboard. Press the TRANSPOSE button and its indicator will light. Set the Transposition to a value between -36 and 36 using the +/- buttons or numeric buttons located below the left-hand digital display. The +/- buttons increase and decrease the TRANSPOSE value by one octave (12 semitones). A value input with the numeric buttons is automatically applied a + or - value. For example, if -12 is currently displayed and you input a value of 01, -01 will be the displayed value.

- * Data received from a REMOTE KEYBOARD is also affected by the TRANSPOSE function.
- * The default setting is 00. Press the + and - buttons simultaneously to set the value to 00.

NOTE: To Transpose the keyboard in the SPLIT VOICE mode, press a note in the left-hand section of the keyboard to transpose the left-hand section, and press a note in the right-hand section of the keyboard to transpose the right-hand section.

NOTE: The SOUND MODULE also has a TRANSPOSE mode, which directly affects the tone generator (refer to page 76). This means the SOUND MODULE TRANSPOSE function transposes the sound production of all Channels simultaneously. Also, the Channel Status COARSE TUNING function transposes the notes in semitone units, but this function changes the MIDI tuning data value set to each Channel.

NOTE: The KEYBOARD'S TRANSPOSE function affects only data generated on the keyboard. It does not affect Sequencer data. However, because it affects chord data from a keyboard, Auto Accompaniment is also affected.

● Changing the SPLIT POINT

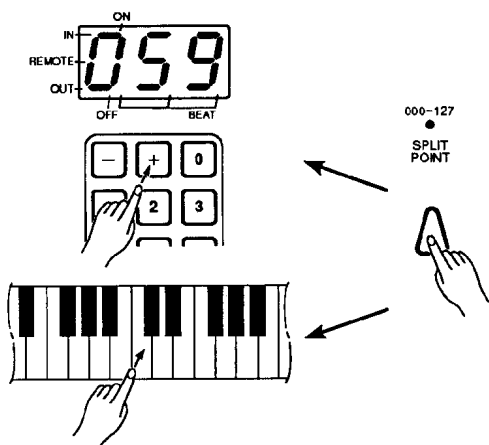

The SPLIT POINT function allows you to change the Split Point for the KEYBOARD CHANNELS or Auto Accompaniment. Press the SPLIT POINT button and its indicator will light. Change the split point by holding down the SPLIT POINT button and then pressing the key you want to set as the new Split Point. That key will then become the last key and highest note of the left-hand section. In addition, each key on the keyboard has a MIDI note number printed above it. Use the +/- buttons or numeric buttons located below the left-hand digital display to enter the number of the key you want to set as the new Split Point.

- * The MIDI note number of the set Split Point appears in the left-hand digital display.
- * When using a remote keyboard with more than 62 keys, the split point can be set to any value between 000 and 127.
- * Use the SPLIT POINT function for Auto Accompaniment's three FINGERING modes (SINGLE FINGER, FINGERED 1, and FINGERED 2). You can set a Split point value to each fingering mode. Make sure Auto Accompaniment is on, then press the desired FINGERING button and set the split point. The factory set SPLIT POINTS are: KEYBOARD SPLIT - MIDI # 59 (B2), SINGLE FINGER - MIDI # 49 (C#2), FINGERED 1 - MIDI # 54 (F#2), FINGERED 2 - MIDI # 54 (F#2).
- * Activating AUTO ACCOMPANIMENT will override any previous split point settings and change the split point to the setting for the selected Auto Accompaniment's FINGERING.

● NOTE PROCESSOR



The NOTE PROCESSOR adds a Harmony or Effect to notes played on the keyboard. The Note Processor has 20 types of HARMONY and a total of twelve NOTE EFFECTS (six different Effects, each with a RHYTHM SYNCHRONIZED and a RHYTHM ASYNCHRONIZED version). Each of the twelve NOTE EFFECTS has five speed variations. Press the NOTE PROCESSOR button and its indicator will light. Refer to the top right of the keyboard to select a Harmony or Effect from 00 through 79, then use the numeric buttons below the left-hand digital display to input your selection. Activate the NOTE PROCESSOR by pressing the NOTE PROCESSOR ON/OFF button below the NOTE PROCESSOR button.

- * HARMONY adds a harmony to the melody played in the right-hand section of the keyboard. When using the SPLIT VOICE mode or AUTO ACCOMPANIMENT mode, Harmony is added based on the chords played in the left-hand section of the keyboard. However, HARMONY numbers 01, 02, 10, 12, 13, 14, and 18 have preset note intervals, so the left-hand section chords will have no effect on the Harmony produced.
- * NOTE EFFECTS repeatedly generate notes played on the keyboard with the Effect applied. RHYTHM SYNCHRONIZED effects are synchronized to the selected tempo. RHYTHM ASYNCHRONIZED effects are produced at a preset rate, so the tempo played has no influence. Each NOTE EFFECT has five speed variations. For example, the RHYTHM SYNCHRONIZED PAN ECHO Effect consists of Effect numbers 20 - 24. All five variations of an EFFECT produce the same sound, but the higher the variation number, the faster the Effect is repeatedly reproduced.

NOTE: When using the SPLIT mode, NOTE PROCESSOR effects are only produced in the right-hand section of the keyboard.

NOTE: When multiple KEYBOARD CHANNELS are active, an activated NOTE PROCESSOR Effect affects only the Channel which was turned on first.

- * The default setting is 00, DUET.
- * The function of the NOTE PROCESSOR ON/OFF button can be assigned to the FOOT PEDAL. For more information refer to the PEDAL ASSIGN section on page 64.

3. KEYBOARD

HARMONY			
00	DUET	10	1+4+5+8
01	1-4	11	BLOCK
02	1+5	12	4th INTERVAL BUILD
03	COUNTRY	13	OCTAVE1
04	TRIO1	14	OCTAVE2
05	TRIO2	15	STRUM (TRIO)
06	4 WAY CLOSE BASIC	16	STRUM (4WAY BASIC)
07	4 WAY OPEN BASIC	17	STRUM (4WAY JAZZ)
08	4 WAY CLOSE JAZZ	18	STRUM (1+4+5+8)
09	4 WAY OPEN JAZZ	19	STRUM (BLOCK)

NOTE EFFECT (RHYTHM SYNCHRONIZED/RHYTHM ASYNCHRONIZED)	
20-24 / 50-54	PAN ECHO
25-29 / 55-59	PAN TREMOLO
30-34 / 60-64	PAN GLISSANDO
35-39 / 65-69	PAN TRILL
40-44 / 70-74	POLY ECHO
45-49 / 75-79	POLY TREMOLO

- * The Note Effects PAN GLISSANDO (by semitone) and PAN TRILL are generated only when two keyboard notes are played simultaneously.
- * The POLY ECHO and POLY TREMOLO effects are polyphonic. All other NOTE EFFECTS are monophonic.

● PITCH BEND RANGE (for transmission)

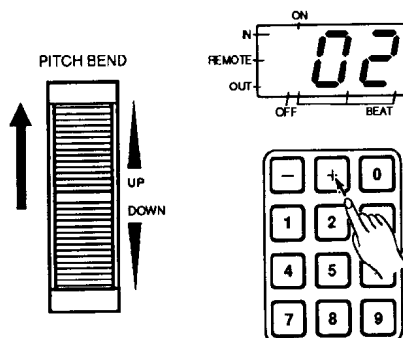

Use this function to alter the maximum output value of the PSR-SQ16's Pitch Bend wheel. Roll the Pitch Bend wheel completely up or down and the currently set range will appear in the left-hand digital display. Use the +/- buttons or numeric buttons below the left-hand digital display to calibrate the maximum value range of -12 (roll the wheel up and bend the note down one octave - 12 semitones) and 12 (roll the wheel up and bend the note up one octave - 12 semitones). Each adjustment increment equals one semitone. The default Pitch Bend Range Adjustment setting is +2.

- * The Pitch Bend Range set here will be both the maximum Pitch Bend value output on the PSR-SQ16, and the Pitch Bend range when data is transmitted via MIDI OUT. Please refer to the following table for the relationship between the Pitch Bend Range set value and the MIDI data value.

■ The relation between the Pitch Bend Range set value and the MIDI data value to be transmitted.

Value	MIDI Data		Value	MIDI Data	
	DOWN Min.	UP Max.		DOWN Min.	UP Max.
-12	127.127	~ 00.00	1	118.58	~ 10.69
-11	114.121	~ 12.5	2	108.53	~ 20.74
-10	104.116	~ 22.10	3	96.47	~ 30.79
-9	94.111	~ 32.15	4	86.42	~ 42.85
-8	84.106	~ 44.21	5	76.37	~ 52.90
-7	72.100	~ 54.26	6	64.31	~ 62.95
-6	62.95	~ 64.31	7	54.26	~ 72.100
-5	52.90	~ 76.37	8	44.21	~ 84.106
-4	42.85	~ 86.42	9	32.15	~ 94.111
-3	30.79	~ 96.47	10	22.10	~ 104.116
-2	20.74	~ 108.53	11	12.5	~ 114.121
-1	10.69	~ 118.58	12	00.00	~ 127.127

- * PITCH BEND RANGE and PITCH BEND SENSITIVITY values that result in the same product will produce the same PITCH BEND effect (refer to page 35).

NOTE: Pitch Bend Range appears in the left-hand digital display, while Pitch Bend Sensitivity simultaneously appears in right-hand digital display. This indicates the tone generator's sensitivity when Pitch Bend data is received and used as Channel Status data. Refer to "Pitch Bend Sensitivity" on page 35 for details.

4 AUTO ACCOMPANIMENT

The PSR-SQ16 AUTO ACCOMPANIMENT function provides a musical accompaniment that you can perform along with by playing the keyboard. There are 269 preset AUTO ACCOMPANIMENT styles. Use the AUTO ACCOMPANIMENT section to its greatest potential by applying the following settings to a style you've selected.

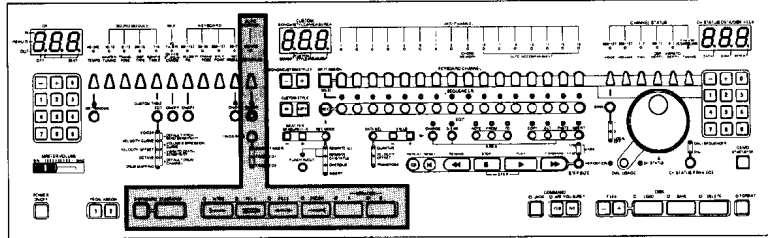

● STYLE SELECT



To select a preset AUTO ACCOMPANIMENT style, press the STYLE # button and its indicator will light. Refer to the Style list on the top of the PSR-SQ16's front panel, and choose a style from Full Accompaniment, Part Accompaniment, or Rhythm Style. Use the numeric buttons below the left-hand digital display to input the style number you've selected. The number you input will appear in the left-hand digital display.

* For more details on the contents of the Style List, refer to the List Book.

● AUTO ACCOMPANIMENT ON/OFF

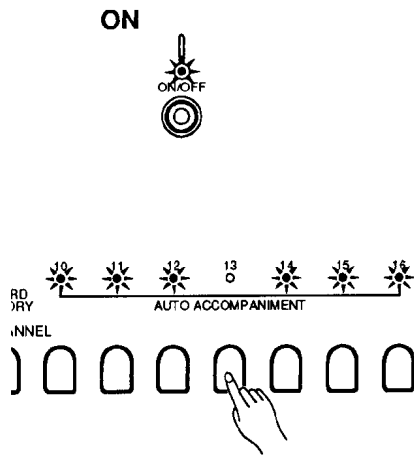

This button activates or deactivates the Auto Accompaniment mode.

The Auto Accompaniment mode is activated. When Auto Accompaniment is ON, Channels 10 through 16 perform an Auto Accompaniment's individual parts. Channel 9 controls an Accompaniment style's chord progressions, and therefore produces no sound. The selected Auto Accompaniment style supplies the CHANNEL STATUS settings for Channels 10 through 16. The Accompaniment performs in accordance with the chords played in the left-hand section of the keyboard. The selected FINGERING mode (refer to the next page), determines which chords can be played in the left-hand section.

* When Auto Accompaniment is activated, the indicators of Channels 10 through 16 will light. Press the button of any Auto Accompaniment Channel 10 through 16 that you want to turn ON or OFF. Activating Auto Accompaniment will cancel the left-hand section or right-hand section assignments of Keyboard Channels 10 through 16. However, left-hand or right-hand Split keyboard settings of Channels 1 through 8 will be unaffected.

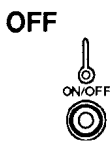

The AUTO ACCOMPANIMENT is deactivated. If the Auto Accompaniment START button is pressed when the AUTO ACCOMPANIMENT is OFF, only a rhythm is generated.

4. AUTO ACCOMPANIMENT

NOTE: When Auto Accompaniment is on, each Channel Status (including Pitch bend, Sustain, and Expression), except for Volume, affects only the right-hand section of the keyboard. Channel Status Volume can adjust an Accompaniment's overall volume (Group operation of Keyboard Channel 10 through 16).

- Auto Accompaniment ON/OFF is transmitted from the keyboard module as an Exclusive message to the MIDI BUS. Also, Style numbers and Sections are transmitted as Exclusive messages. It is possible to control the Auto Accompaniment by recording Section and Style number Exclusive messages in Channel 9.
- Note data received in Channel 9 from an external device through the MIDI IN connector is used as chord performance data to control Auto Accompaniment playback.

● FINGERING (refer to page 19 - 21)

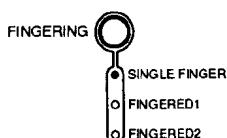

The three fingering modes of the PSR-SQ16 are listed below.

SINGLE FINGER: You can use a maximum of three fingers in the left-hand section to generate basic chords.

FINGERED 1: You are free to play the chords of your choice.

FINGERED 2: The same as FINGERED 1, except this mode also recognizes "on" chords (for an explanation of "on" chords refer to page 21).

● ACCOMPANIMENT SECTIONS (refer to page 16 - 17)

AUTO ACCOMPANIMENT contains a total of 10 section types (A and B variations of 5 different types: Intro, Main, Fill 1, Fill 2, and Ending). The illustration below displays the relationships between AUTO ACCOMPANIMENT sections.

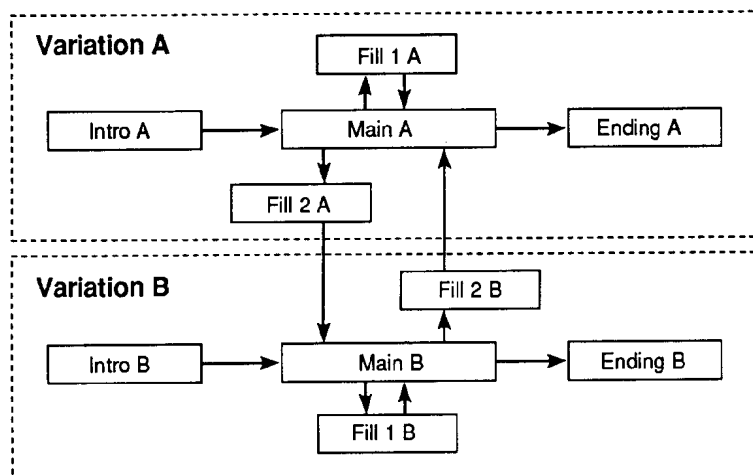

NOTE: When a new AUTO ACCOMPANIMENT section is selected, it begins playing at the start of the next measure. Fill-in sections (Fill 1 or Fill 2) start immediately when selected. However, a Fill-in section selected after the first beat of the last measure starts from the next measure.

Preselecting Sections

You can preselect the next section to be played while another section is playing.

When the Intro A section is playing (INTRO indicator is lit), the Variation A indicator flashes, indicating that the Main A section is preselected (it will be the next section to play). When the Intro section A is finished (its indicator goes out), the Variation A indicator lights as the Main A section immediately begins playing. When one section has finished and another is beginning, you can preselect the next section to be played.

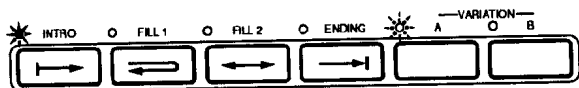

Example 1: How to go from Intro A to the Main B section (preselecting the Main B section)

Let's say the Intro A section is playing (its indicator is lit), and the Variation A indicator is flashing. If you press the Variation B button, Variation A's indicator will light and Variation B's indicator will flash, indicating that the Main B section is preselected. When the Intro A section is completed, the Main B section will immediately begin playing.

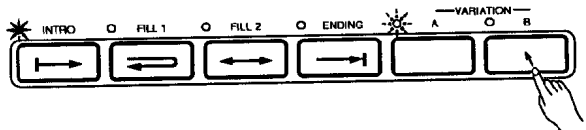

Example 2: How to go from the Main B section to the Ending A section (preselecting the ending A section).

Let's say the Main B section is playing (its indicator is lit). Press the Variation A button and its indicator will flash. While the Variation A indicator is flashing, press the Ending button. Then both the Ending and the Variation A indicators will flash, and the Ending A section will be preselected. The Ending A section will immediately begin playing at the start of the next measure.

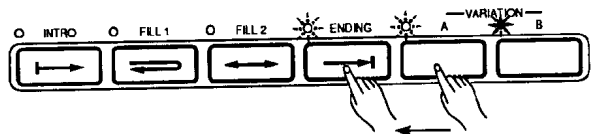

Use this method to preselect the Intro A, Main A, Ending A, Intro B, Main B, and Ending B sections.

NOTE: Fill-in sections start immediately after the Fill 1 or Fill 2 buttons are pressed, so Fill-in sections cannot be preselected. However, a section which follows a Fill-in section can be preselected.

NOTE: Rhythm stops automatically when an Ending section finishes playing. However, pressing the Fill 1 or Fill 2 button while an Ending section is playing will immediately begin play of the selected Fill-in section. Then the Accompaniment will go to the Main section automatically, and the rhythm will not stop. If a section is preselected to follow an Ending, the Accompaniment goes to that preselected section without stopping the rhythm.

5 SEQUENCER

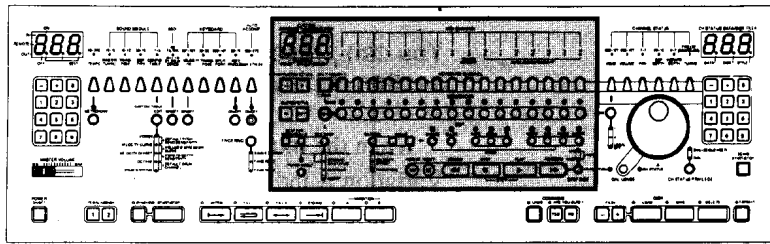

ABOUT THE SEQUENCER

Use the SEQUENCER of the PSR-SQ16 to record, playback, and edit music data you create. The PSR-SQ16's SEQUENCER has 16 tracks to which you can individually record data. You can simultaneously play back all recorded tracks.

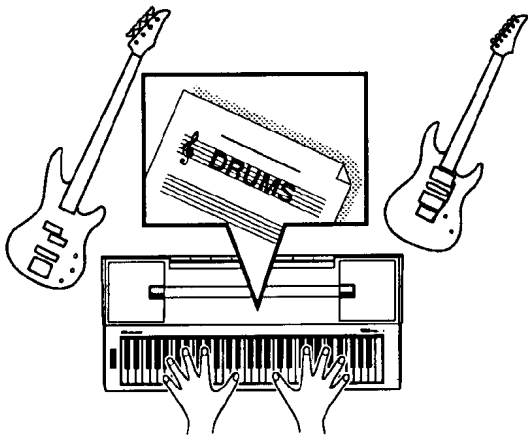

● The Case of the Missing Band Member

Let's say you have a band: guitar, bass, drums, and keyboard. You need to practice your new song tonight for your performance tomorrow, but something's come up and your drummer can't make rehearsal. Dismayed? Don't be! Record the drum performance into the PSR-SQ16's Sequencer. Now you can rehearse with three members and the playback of the rhythm track you've recorded.

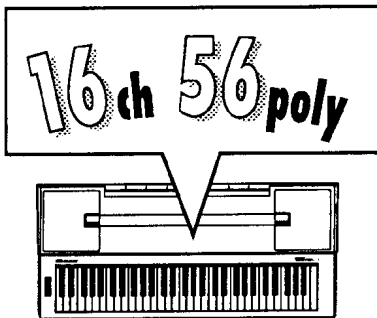

● 16 Channel Sound Quality

You can use the 16 tracks of the Sequencer to create music that sounds as though it were performed by a sixteen member orchestra. The PSR-SQ16's tone generator has a maximum polyphony of 56 notes (28 polyphony notes per bank). The tone generator produces a rich ensemble sound when multiple tracks are used.

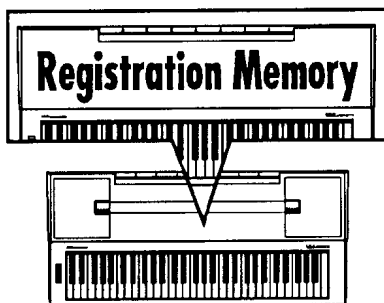

● Using the Sequencer as Registration Memory

The PSR-SQ16's sequencer can record and playback each Channel's Channel Status settings. Since other panel settings can also be recorded and recalled with songs, this function can be used as memory of the panel settings.

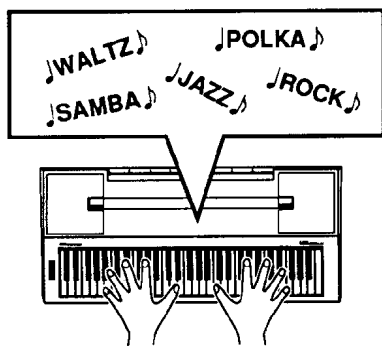

● **When recording, make the most of Auto Accompaniment's preset styles.**

AUTO ACCOMPANIMENT styles consist of multiple Voices intricately combined. Incorporating the preset AUTO ACCOMPANIMENT styles (described on page 16) into your original music is convenient, time saving, and maximizes the Sequencer's playback function. First, select and record an Auto Accompaniment style appropriate for your original tune (refer to RECORDING, page 44). Then, record your tune along with the Auto Accompaniment playback, and finally edit the combined recording to your taste (refer to EDIT, page 53). Using this method makes recording your original tunes very easy. Record AUTO ACCOMPANIMENT to Sequencer Tracks 10 through 16. By doing so, you can edit the individual Auto Accompaniment parts recorded on each Track, and thereby give variety to the Accompaniment. If you record Auto Accompaniment to Track 9, only the progression of chords you play in the left-hand section will be recorded. You can apply a progression of chords you've recorded with one Auto Accompaniment style to any other Auto Accompaniment style. Simply select a new style, then begin playback of the chords you've recorded. Also, recording only chords saves a great deal of memory.

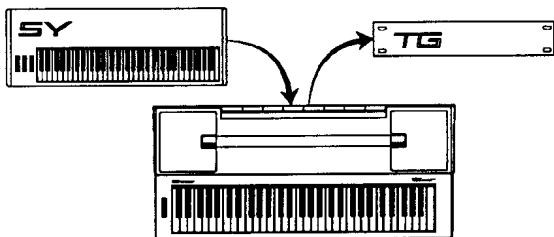

● **Use MIDI for high level Sequencer performance**

Because the PSR-SQ16 is a MIDI keyboard, data from external sources can be recorded into its multi-track Sequencer. The PSR-SQ16's Sequencer can also transmit data to other external tone generators and control their sounds.

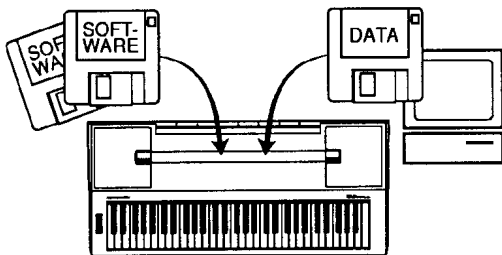

● **Other sequencer or computer-related third party software data can also be used.**

The PSR-SQ16 can accept Standard MIDI Files, so using other data or software is possible. Improve the match of the PSR-SQ16 to data formats by using the Configuration Table (refer to page 77) to adjust voice numbers and volume balance.

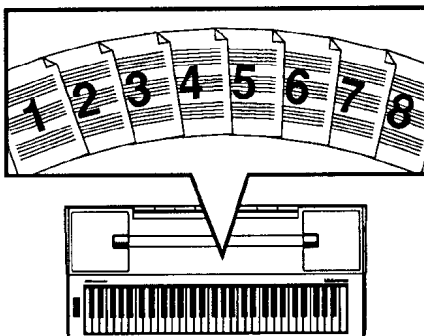

● **The SEQUENCER can record a total of 8 songs**

The SEQUENCER memory of the PSR-SQ16 can retain 8 recorded Songs, with a total of 15,000 notes. These Songs are retained within the internal memory even when the power supply is turned off. However, if the power cord is unplugged when the PSR-SQ16 is ON, its internal memory will be permanently lost. We recommend you save to a 3.5 inch floppy disk any important data you don't want to risk losing, or any song data you want to save for a long period of time. In this way you can make your own original music library.

5. SEQUENCER

RECORDING

Begin recording by using one KEYBOARD CHANNEL and recording a single track into the SEQUENCER.

1. Select a Song number

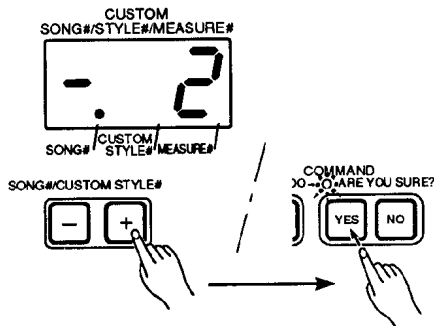

Use the +/- buttons below the center digital display to select a Song number, 1 - 8. Select the Song number that does not have data such as Disk Demo Song data (refer to page 25). Make sure that the SONG# dot at the bottom of the center digital display is lit. If the CUSTOM STYLE # dot is lit, press the CUSTOM STYLE ON button and the Song dot will light. The ARE YOU SURE? indicator flashes after a Song number is selected. Press the YES button to set the Song number. (Press the NO button to cancel the operation.)

NOTE: "F" appears on the displays before song numbers that contain data, while "-" displays before song numbers that do not contain data.

NOTE: The condition setup (all data described as "initial setting values" in List Book) is recorded to each song. If the new Song number is selected, the setting for the new Song will be recalled. (Previous Song's condition setup is automatically stored.)

NOTE: To change the Song number without changing the current condition setup, first change the Song number, then hold down the UNDO button and press the ARE YOU SURE? YES button.

2. Select a KEYBOARD CHANNEL

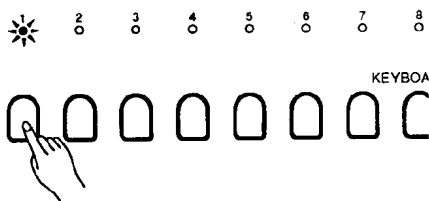

Select a Channel from 1 through 16 to record (KEYBOARD CHANNELS are discussed in Section 1). Press the button of the Channel you've selected and its indicator will light. Change any of the various CHANNEL STATUS and KEYBOARD settings you wish (CHANNEL STATUS and KEYBOARD settings are respectively described in Sections 2 and 3).

3. Prepare to record

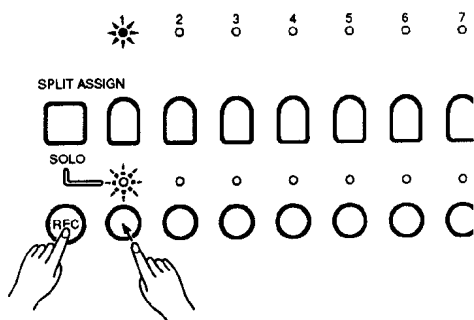

Hold down the REC button, then press the SEQUENCER button directly below the activated KEYBOARD CHANNEL. The SEQUENCER button's indicator will then flash, and the Sequencer is now ready to record. Now, set the Recording mode to REWRITE ALL (refer to REC MODE page 48). If you set the tempo and start the metronome (refer to page 65), you can follow the tempo and the metronome's beat, and recording will be easier (the tempo will be recorded, but not the metronome). At this point, the left-hand display's three beat dots (refer to page 22) will flash simultaneously, in time to the tempo.

NOTE: To simultaneously record PSR-SQ16's keyboard performance along with external data from MIDI IN, prepare the PSR-SQ16 for recording by pressing the SEQUENCER button of the Channel that corresponds to the input MIDI channel. In this case, the indicator of Keyboard Channel for external data does not have to be lit.

NOTE: Performance data from the REMOTE KEYBOARD terminal is recorded in the same way as PSR-SQ16 keyboard performance data.

4. Beats per Measure

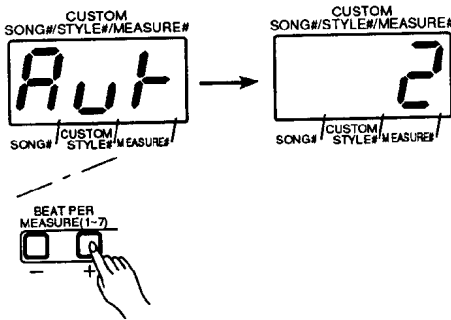

You can select the number of beats per measure for a song you record. To set the beats per measure, use the BEAT PER MEASURE +/- buttons located below the center digital display to set an amount from 1 through 7. For example, set the value to "3" to record a song at 3 beats per measure; set the value to "4" to record a song in 4 beats per measure, etc. You can also select "Aut (AUTO)", which automatically set the beats per measure based on the selected AUTO ACCOMPANIMENT style.

NOTE: When recording a progression of chords to Channel 9, the BEAT PER MEASURE setting is always "Aut (AUTO)". This setting cannot be changed. However, if you record a new Accompaniment with a different beat, the new Accompaniment beat will be set automatically.

NOTE: The set BEAT PER MEASURE value affects only the recorded area. It is therefore possible to record the different beat in the specified area of a song. If you change a beat in the same area, the last value set is effective.

NOTE: In REWRITE CH STATUS or OVERDUB mode, the beat can not be recorded.

5. Start recording

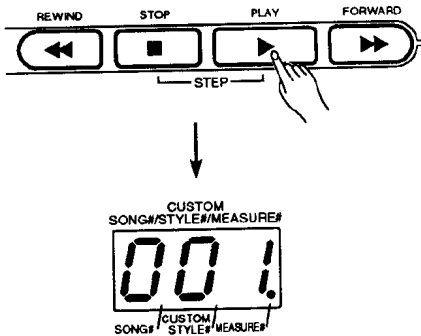

Press the PLAY button and Recording will begin. The SEQUENCER also begins recording with the first note you play on the keyboard. The current measure number appears in the center digital display. The three Beat dots of the left-hand digital display indicate the beat when the SEQUENCER is recording.

NOTE: If the set Beat Per Measure is 5 or greater, the left-hand digital display indicates the beat as follows.

5 beats per measure: the fourth and fifth beats will be indicated by the right dot.

6 beats per measure: The fourth through sixth beats will be indicated by the right dot.

7 beats per measure: The fourth through seventh beats will be indicated by the right dot.

6. Stop recording

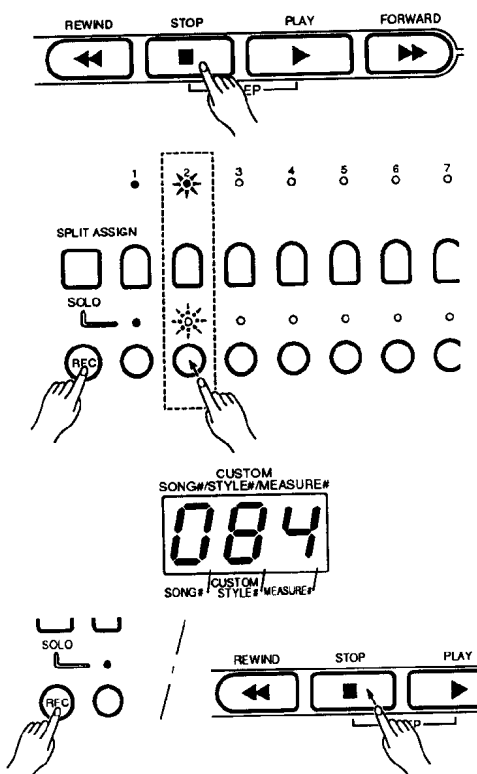

Press the STOP button to stop recording. The measure count in the center digital display will stop and automatically return to the measure where you began recording. Also, the SEQUENCER indicators of all recorded tracks will light.

* If the indicator of the recorded track does not light, that means recording has not taken place for that track. This is due to the SEQUENCER track not matching the Keyboard Channel, or for some other reason. Go back to Step 2 (Select a KEYBOARD CHANNEL) and try recording again.

If you want to record another channel, select a KEYBOARD CHANNEL. Then hold down the REC button and press the SEQUENCER button that corresponds to the selected KEYBOARD CHANNEL. The Sequencer is now ready to record that channel. In this case, remember to select a Keyboard Channel corresponding to that track as described in procedure 2.

* By holding down the REC button and the STOP button at the same time, the center display will show the remaining Sequencer memory (1 value = 1 kilobyte of memory) for as long as the buttons are held down.

5. SEQUENCER

PLAYBACK

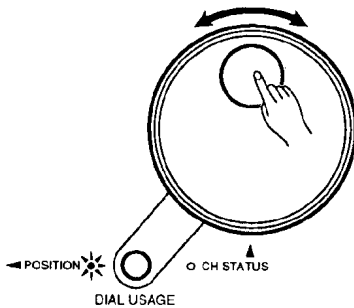
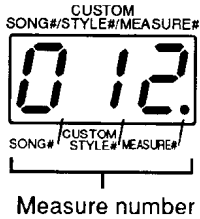
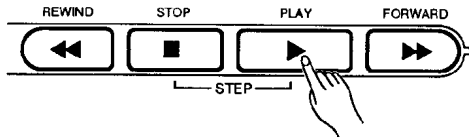

To play back the Sequencer, press the SEQUENCER buttons of tracks you want to play back, and their indicators will light. (Indicators of tracks that contain data will also light when recording is completed and the RESET button is pressed.) Press the PLAY button and playback of the PSR-SQ16 Sequencer will immediately begin. Stop playback at any time by pressing the STOP button.

Use the Sequencer FORWARD or REWIND buttons to select the number of a measure from which you would like to begin playback. You can do this when the Sequencer is playing or stopped. Pressing the FORWARD button increases the measure number by one, and pressing the REWIND button decreases the measure number by one. Hold down the FORWARD button to increase measure numbers continuously, and hold down the REWIND button to decrease measure numbers continuously. Return to measure number 1 by pressing the RESET button. If you press the DIAL USAGE button, the POSITION indicator will light, and the DIAL may then be used for measure number selection (refer to page 32).

- * Turn any track ON or OFF during playback by pressing the corresponding SEQUENCER button.
- * The Sequencer's RESET, REWIND, PLAY, STOP, and FORWARD functions can all be assigned to an optional foot switch. For more information, refer to the PEDAL ASSIGN section on page 64.

NOTE: If no Sequencer indicators are lit, pressing the PLAY button once will light the indicators of all tracks that hold recorded data. Press the PLAY button a second time and playback of the tracks whose indicators are lit will begin.

NOTE: If you start Auto Accompaniment during sequencer playback, in order to be synchronized with the sequencer, Auto Accompaniment begins with the start of the next measure.

NOTE: Channel status changes of the sequencer are recorded in the position the change is made. Therefore, if you use the REWIND button or the DIAL to return a performance data position and then play back, the channel status change is not always reproduced properly. If this is the case, press the RESET button while holding down the STOP button. The data will be re-read from the beginning of the song (Updating), and the correct channel status will be set in the current position. If you play back in this condition, the channel status change will be reproduced properly.

NOTE: When the indicators of any tracks that contain recorded data are lit, press the STOP button twice, and the indicators of all tracks will go out and the sequencer standby status will be cancelled.

NOTE: When playing back only some of the tracks that contain recorded data, press the RESET button once in order to reset only the tracks currently being played back, and the indicators of those tracks will light. Press the RESET button twice in order to reset all tracks that contain recorded data, and the indicators of those tracks will light.

● SOLO

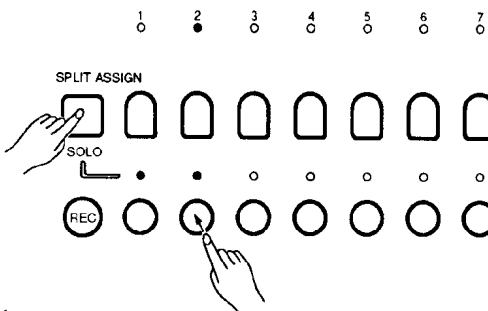

While playback is in progress, you can listen to the playback of a single Sequencer track by holding down the SPLIT ASSIGN/SOLO button together with a SEQUENCER button. The track you've selected will be heard alone for as long as the two buttons are held down. This function is useful for hearing what is recorded on an individual track. (Refer to page 27 in the Basic Operation section.)

RECORDING ALONG WITH THE PLAYBACK

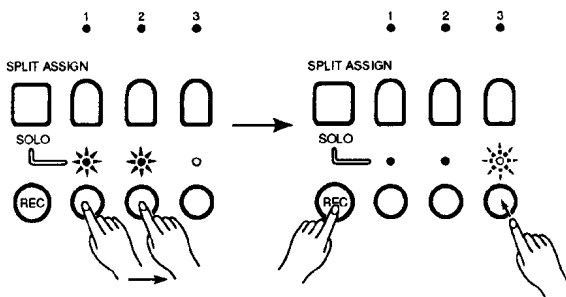

You can listen to previously recorded tracks while you record a new track.

Press the SEQUENCER buttons you want to play back, and their indicators will light. Then, hold down the REC button and press the SEQUENCER button of the track you want to record to, and its indicator will flash, indicating that it is in recording standby mode. If you then press the PLAY button or begin playing on the keyboard, you can start recording to the new track, while listening to the part already recorded.

RECORDING FROM A SELECTED MEASURE



It is possible to begin recording from a selected measure within a song. While the Sequencer is stopped, use the FORWARD or REWIND buttons to select the starting measure.

MULTI TRACK RECORDING

It is possible for you to simultaneously record to several independent tracks. Do this by holding down the REC button, then select the buttons of the tracks to which you want to record. The following will explain how performance data can be recorded into each of the selected tracks.

1. Recording multiple tracks with a keyboard

First select the KEYBOARD CHANNELS you desire, then prepare the Sequencer for recording. By recording simultaneously to several tracks, the same performance data will be recorded to all selected Sequencer tracks, along with each Channel's individual Channel Status settings.

2. Recording left-hand and right-hand Split Voice sections

Set the keyboard to SPLIT mode (refer to page 15) with the Keyboard Channels you desire, then prepare the Sequencer and begin recording.

3. Recording with the Auto Accompaniment

Keyboard Channels 10 through 16 are used to record individual Auto Accompaniment parts. Once you've selected the Keyboard Channels you desire and the Sequencer is prepared, you may begin recording. Channels 1 through 8 may simultaneously record right-hand performance data.

4. Recording the Auto Accompaniment Chord Data

Channel 9 is used to record the Auto Accompaniment chord data you play on the left-hand section of the keyboard. Prepare Channel 9 for Sequencer recording, then record chord progression data (refer to page 50).

5. Recording multiple tracks from the MIDI IN jack

Select the Channels you wish to record by using the MIDI I/O filter settings (refer to page 84). Once the Keyboard Channels and Sequencer are prepared, recording may begin. By activating the MIDI IN CLOCK/COMMANDS function, an external keyboard's start and stop functions may be used to control the functions of the PSR-SQ16's Sequencer PLAY and STOP buttons.

5. SEQUENCER

RECORDING MODE (Type of Recording)

Explained below are the four methods of recording new data to previously recorded tracks.
(For more information regarding the recording procedure, refer to page 44.)

1. REWRITE ALL

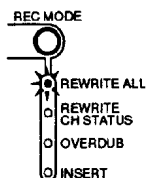

Starting from the measure number you select, new data you record will replace data previously recorded to a track. This mode can also be used to record to new tracks.

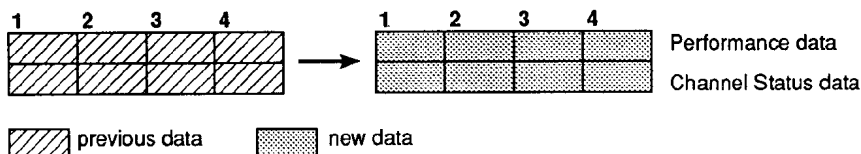

2. REWRITE CH STATUS

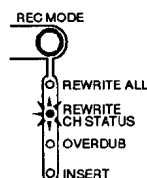

In this mode, you can apply new Channel Status settings to the performance data already recorded. (Only the Channel Status setting currently displayed in the right-hand digital display can be rewritten.) First, prepare the sequencer track for recording, then select its corresponding Keyboard Channel (Refer to page 44). Next, select the Channel Status setting you want to change, and use the DIAL, or the +/- buttons or numeric buttons below the right-hand digital display to enter the new amount you want to set. Finally, press the PLAY and STOP buttons in sequence, and the new Channel Status setting will be applied at the beginning of the selected measure. In addition, if, for example, you record a Volume change, Fade In/Fade Out is also possible.

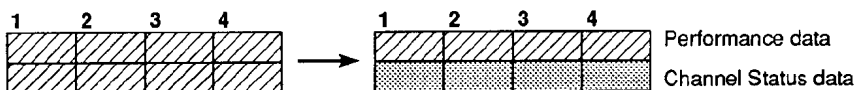

- * To REWRITE Channel Status Pitch Bend, Sustain, and Expression, first select Rewrite Channel Status, then move to the Pitch Bend wheel or press the PEDAL. Rewriting may then begin. The Channel Status settings will be rewritten to the last value set using the Pitch Bend wheel or PEDAL. Pitch Bend is shown as "Pbd" in the right-hand digital display, Sustain as "SUS", and Expression as "EPS".
- * It is also possible to change Channel Status settings after you start recording. The Channel Status setting will be rewritten to last selected value.

3. OVERDUB

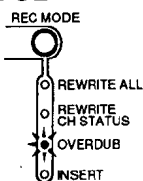

In this mode, you can add new data to previously recorded data.

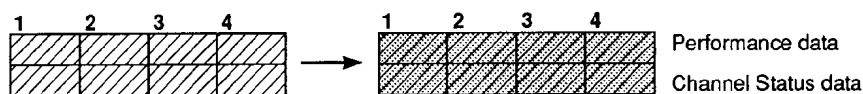

4. INSERT

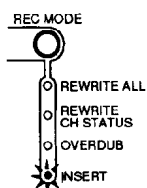

In this mode, performance data and Channel Status setting data will be inserted into a track before the selected measure. Other tracks which are part of the same Song will automatically have blank measures inserted to them in the same position.

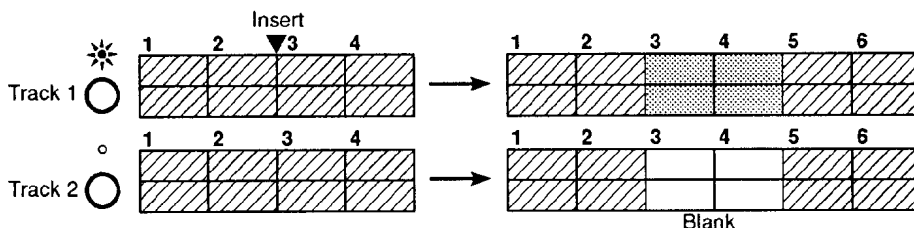

● PUNCH IN/OUT

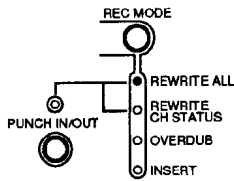

When using REWRITE ALL or REWRITE CHANNEL STATUS, new performance data or new Channel Status data can only be Recorded into a selected track while the PUNCH IN/OUT indicator flashes or the PEDAL is pressed.

First, activate a Sequencer track and its corresponding Keyboard Channel (refer to page 44). Then, press the PLAY button and Sequencer playback will begin. When you come to the point in a Song where you wish to Record, press the PUNCH IN/OUT button or the PEDAL (refer to page 64) and the indicators of the selected Sequencer tracks will flash, indicating that the Sequencer is now recording (PUNCH IN). New data will be recorded for as long as the PUNCH IN/OUT indicator flashes or while the PEDAL is held down. Press the PUNCH IN/OUT button again or release the PEDAL to deactivate the recording mode (PUNCH OUT). Repeat this procedure to record data at other points in a track. Recording will stop when you press the STOP button or when playback reaches the end.

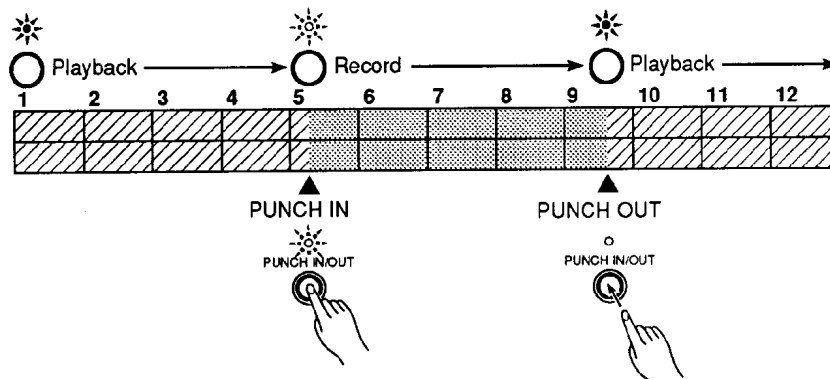

The PUNCH IN/OUT button is pressed in the middle of the 5th measure and data is recorded (REWRITE ALL) until the middle of the 9th measure where the PUNCH IN/OUT button is pressed again (PUNCH OUT).

- * In the PUNCH IN/OUT mode, simultaneously record several tracks by simultaneously activating several KEYBOARD CHANNELS. When Auto Accompaniment is activated, Punch In/Out of channel 9 is not possible.
- * Punch In/Out of a track is possible, whether recording is completed or not, or whether a track is being played back.
- * PUNCH IN/OUT button functions can be assigned to a FOOT SWITCH. (For more information, refer to the PEDAL ASSIGN section on page 64).
- * New performance data will replace previous performance data when REWRITE ALL is selected, and new Channel Status data will replace previous Channel Status data when REWRITE CHANNEL STATUS is selected.

👉 HINT

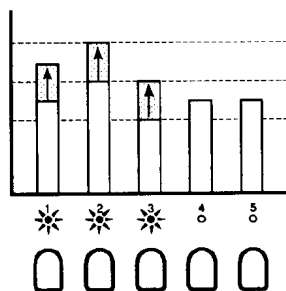
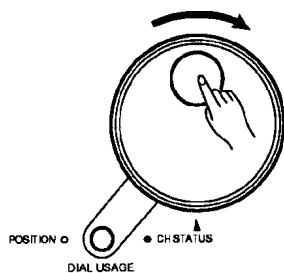

Using the DIAL as a Group fader

You can use the DIAL to simultaneously adjust the volume of all Keyboard Channels activated as a GROUP. While Sequencer data plays back, activate the Keyboard Channels whose Voice setting you want to adjust. Select the VOLUME Channel Status setting (refer to page 33), and make sure the DIAL USAGE CH STATUS indicator is lit (refer to page 32). Then, use the DIAL to simultaneously alter the Volume of the selected Keyboard Channels. Carry out this operation in the Rewrite Channel Status mode to simultaneously change the recorded Channel Status Volume setting.

You can also use the DIAL to alter the Volume of individual Keyboard Channels during Sequencer playback. This allows you to adjust the sound balance of your song.

5. SEQUENCER

RECORDING WITH AUTO ACCOMPANIMENT

Press the AUTO ACCOMP. ON/OFF button and its indicator will light.

- Record Auto Accompaniment performance data in the same way as data produced on the keyboard (using Channels 10 through 16).

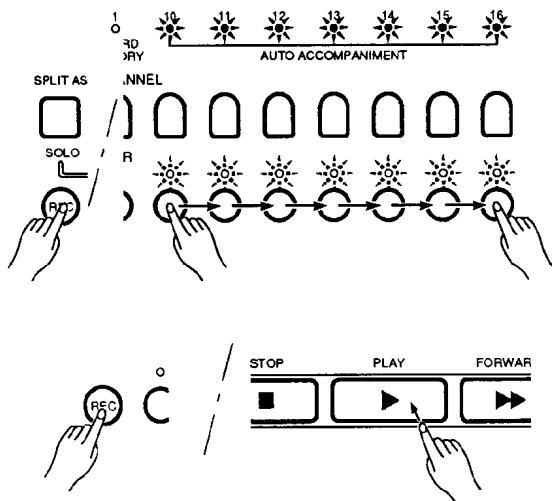

Each separate part of every Auto Accompaniment style is performed on Channels 10 through 16. Record every note of an Auto Accompaniment style, in the same way as data generated on the keyboard, by holding down the REC button, and then pressing SEQUENCER buttons 10 through 16 (thus activating those tracks for recording). The data of each separate Keyboard Channel, 10 through 16, will be individually recorded to its corresponding Sequencer track.

- * By recording Auto Accompaniment to Keyboard Channels 10 through 16, key note data is recorded into each track. Therefore, the data of each track can be edited. However, this recording procedure uses much more PSR-SQ16 memory than recording just chord data, which is described below.
- * Easily prepare Sequencer tracks 10 through 16 to record Auto Accompaniment in this way: Hold down the REC button, press the PLAY button, and any presently selected KEYBOARD CHANNEL, along with KEYBOARD CHANNELS 10 through 16, will simultaneously be prepared to record.

- Recording Auto Accompaniment's Chord Data (Using Keyboard Channel 9)

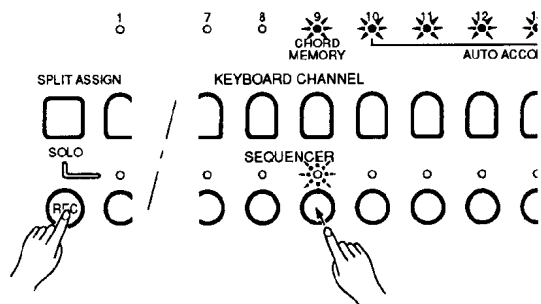

Keyboard Channel 9 is used to record Auto Accompaniment chord data. Chord data recorded to Channel 9 controls an Auto Accompaniment's performance. Also, Auto accompaniment ON/OFF, section progression (INTRO, FILL, ENDING, etc.), on and off of each channel, and Auto Accompaniment's overall volume are all recorded to Channel 9, so playback is exactly the same as the performance data recorded.

- * Recording only an Auto Accompaniment's chord data uses a small amount of PSR-SQ16 Sequencer's memory. Also, Auto Accompaniment style numbers, chord data, and Section data can all be changed. However, individual Auto Accompaniment parts cannot be edited.

NOTE: You cannot simultaneously record to Channel 9 and Channels 10 through 16.

REPEAT RECORDING AND PLAYBACK

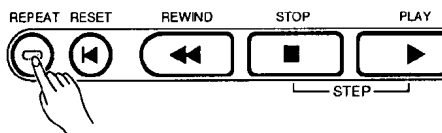

During recording or playback (or simultaneous recording and playback), press the REPEAT button and the rhythm will stop at the end of the current measure. The recording or playback will then repeat, after a one-measure break, from the measure at which recording or playback began.

NOTE: If there is any Channel Status changes (such as a Voice change) in the data being repeated, it will not be updated. (Refer to page 46)

NOTE: Repeat recording is not possible in the INSERT recording mode.

NOTE: A tied note or a portamento at the repeat point will not be recorded.

STEP MODE

Activate the PSR-SQ16 STEP mode by holding down the STOP button and pressing the PLAY button.

● WHAT IS STEP MODE?

On measure (4/4)

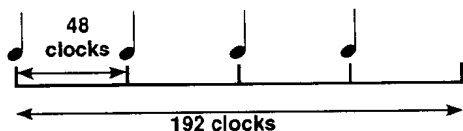

- One measure consists of 192 clocks.
- One beat (a quarter note) consists of 48 clocks.

In PSR-SQ16 recording and playback, one measure is divided into 192 equal divisions (for 4/4 time). Performance data is recorded to these divisions, which are called CLOCKS. The STEP mode's function is the same as Sequencer playback and recording, with the exception that it allows you to progress step by step through sequencer data in CLOCK unit increments. Thus, you can record and playback in manual tempo, enabling you to properly check or input data. Also, people who may not be very good at playing the keyboard can easily and correctly input data.

NOTE: To record in the Step mode from the outset (no performance data exists), first enter the Recording standby mode (refer to page 44), then enter the Step mode.

1. Enter the STEP mode, and set the STEP size.

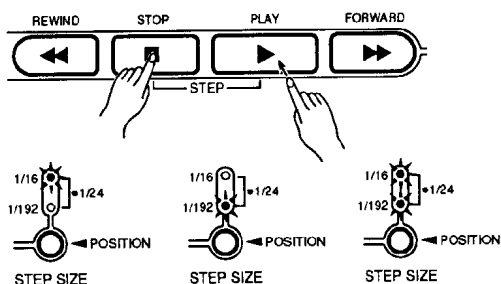

Hold down the STOP button and press the PLAY button to activate the STEP mode. (MEASURE# dot below the center digital display will flash.)

When only the upper indicator is lit, the STEP size is set to the 1/16 mode. When only the lower indicator is lit, the STEP size is set to the 1/192 mode. When both indicators are lit, the STEP size is set to the 1/24 mode.

The center digital display shows the beat and the clock within the measure. The beat is the center digital display's left figure (if it is 4 time, 1 ~ 4 are displayed), and the center and right figures are the clock (00 ~ 47 are displayed). One beat is divided into 48 equal clocks).

* Press the PLAY button in the STEP mode and the current measure number appears in the center digital display for as long as the button is held down.

2. Move in Steps.

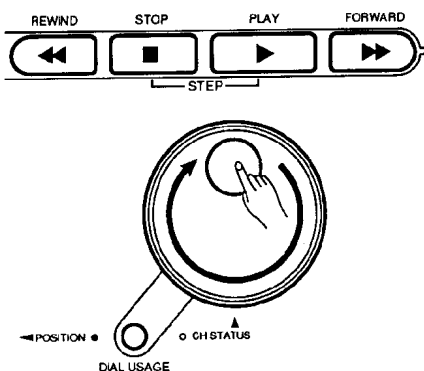

Use the FORWARD and REWIND buttons to increase or decrease the performance data position (clock) by 12 increments (1/16 mode), 8 increments (1/24 mode), or 1 increment (1/192 mode). Hold down the FORWARD or REWIND button to respectively increase or decrease the performance data position continuously.

If you set DIAL USAGE (refer to page 32) to POSITION, you can also use the DIAL to increase or decrease the performance data position.

It takes time to change measure numbers in the STEP mode, so it is better to select the measure you want to check or edit before entering the STEP mode.

* In the Step mode, move to the position where there is data, then sound will be generated.

3. Press the STOP button to exit the STEP mode.

5. SEQUENCER

● Recording in the STEP mode

To record in the STEP mode, use the DIAL or the FORWARD and REWIND buttons to select the “note on” point on the center digital display. Once you’ve selected that point, initiate STEP mode recording by pressing the PUNCH IN/OUT button, then press a key. Then, while holding down the key, select the “note off” point, then release the key. The space between the “note on” point and the “note off” point you’ve selected will be the note’s gate time (length of sound). This is the manner in which a note is recorded. To finish the STEP mode recording, press the PUNCH IN/OUT button once again.

HINT

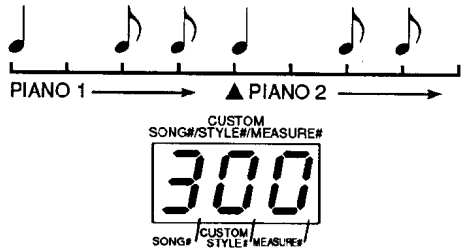

Voice alteration at the third beat of the measure.

Rewrite Channel Status data using the STEP mode

Use the STEP mode to rewrite previously set Channel Status settings. First turn on the Recording mode’s REWRITE CH STATUS function, then set to the point in a Song you wish to make a Channel Status setting change using the STEP mode. Next set the change value, and press the PUNCH IN/OUT button. Progress the display to the end of the part you want to change, then press the PUNCH IN/OUT button again.

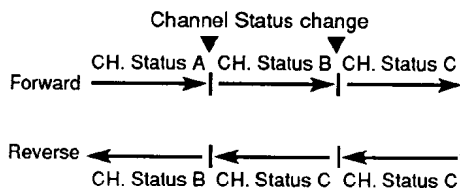

NOTE: Simultaneously recording of Key ON and Key OFF data (when not using FORWARD and REWIND) is not possible.

NOTE: When playing back Sequencer data in reverse (REWIND), sound is produced in the timing of Key ON. If you return to the timing before Key ON, sound will be stopped. Also, Channel Status setting changes operate in a different way from normal playback.

NOTE: When Key On is recorded and played in reverse before Key Off is recorded, the Key On data will not be recorded.

NOTE: The Sequencer RESET function has no effect in the STEP mode.

NOTE: In the 1/16 mode, all performance data assigned to each 12-step increment will perform simultaneously. This data will appear to be quantized (refer to page 55), but it is not quantized. The 1/192 mode and normal playback modes play back performance data as it was recorded (clock by clock).

* The Sequencer FORWARD and REWIND functions can be assigned to the FOOT PEDAL. (For more information, refer to the PEDAL ASSIGN section on page 64).

NOTE: In the Step mode, Auto Accompaniment playback cannot be controlled by the chords recorded to Channel 9 (only the actual notes recorded to Channel 9 will be played back).

Tempo Recording and Playback

Changes in tempo are recorded in relation to the tempo (in percentage) in the beginning part of the song. If you change the tempo at the start of a song, the tempo in the rest of the song will also be changed, maintaining the relationship. If you want to change only the tempo in the beginning part, first display the tempo on the left-hand digital display, then hold down the REC button and press the Tempo button.

ABOUT EDIT

Use the EDIT mode to modify or reprogram Sequencer performance data (Song data and Custom Style data). In the EDIT mode, data between measures specified in a selected track, will be modified. The EDIT functions available are QUANTIZE, VELOCITY OFFSET, TRANSPOSE, CLEAR, COPY, CUT, PASTE, and INSERT.

** Do not use the STEP mode when EDITING.*

■ EDIT Functions

- **QUANTIZE** This operation adjusts the timing of each event between specified measures of a selected track.
- **VELOCITY OFFSET** .. This operation changes the overall Velocity value between specified measures of a selected track.
- **TRANSPOSE** This operation transposes data between specified measures of a selected track.
- **CLEAR** This operation replaces data between specified tracks of a selected track with blank measures.
- **COPY** This operation copies data between specified measures of a selected track and places the data in the PSR-SQ16's edit buffer.
- **CUT** This operation cuts data between specified measures of a selected track and places the data in the PSR-SQ16's edit buffer. The measures that remain will then move up to fill the gap, for all tracks.
- **PASTE** This operation places the data inside the edit buffer at the specified position. (Any data already in the specified position will be mixed with the data in the buffer.)
- **INSERT** This operation takes data placed in the edit buffer and places it at a specified measure within a selected track.

■ The Basic Operation of Each Edit Function

● Setting a track to EDIT

Press the SEQUENCER buttons of the tracks you want to edit, and their indicators will light.

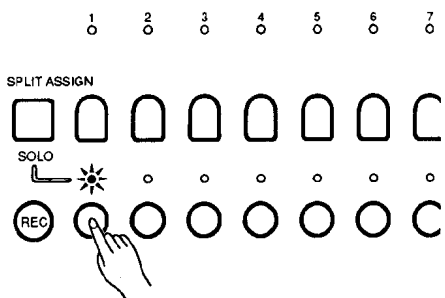

5. SEQUENCER

● Specify the area to EDIT

Specify the EDIT starting point...FROM

Currently selected measure numbers appear in the center digital display. Use the Sequencer FORWARD or REWIND buttons to select a measure you want to edit. Each press of the FORWARD button will increase the measure number by one, and each press of the REWIND button will decrease the measure number by one. Hold down the FORWARD or REWIND button to respectively increase or decrease measure numbers continuously. Measure numbers can also be changed with the DIAL by setting the DIAL USAGE to the POSITION mode. When the measure number you've chosen appears in the center digital display, press the Sequencer FROM button and its indicator will light, indicating that the EDIT starting point (the measure you've selected) is established.

* If the EDIT starting point you selected is not correct, press the FROM button again. Its indicator will go out and a new EDIT starting point can be selected.

Specify the EDIT ending point...TO

After setting the EDIT starting point (or starting measure), select the EDIT ending measure using the method described above. When this is done, press the Sequencer TO button and its indicator will light, indicating that the EDIT ending point you've selected is set.

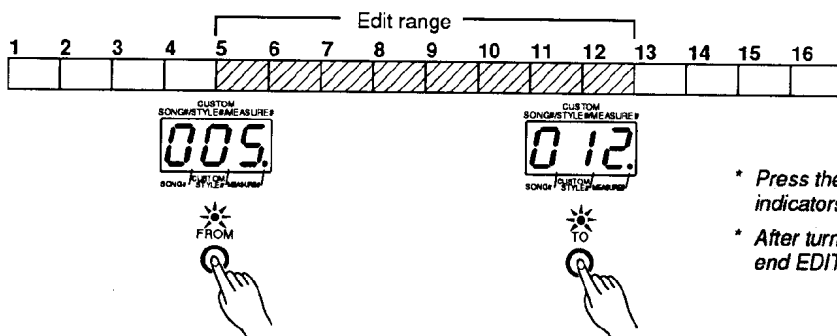

* Press the FROM and TO buttons once again to turn off their indicators, and delete the measure numbers you set.

* After turning off the FROM and TO buttons, set new starting and end EDIT points, and the settings will be activated.

NOTE: If only the FROM point is set, all data from the specified start point to the end of the song will be edited. If only the TO point is set, all data before that point to the beginning of the song will be edited. If neither FROM or TO is set, the entire range of data is applicable for Edit.

NOTE: If you set TO before FROM, the FROM setting will be canceled. The same occurs if you set FROM after TO.

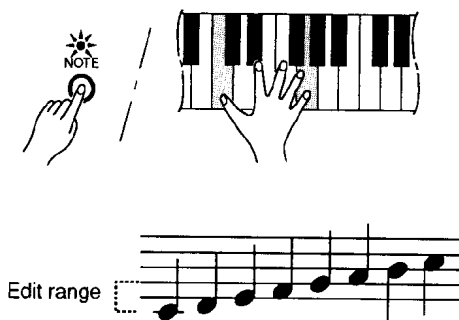

Specify the notes to be edited...NOTE

You can edit a specific note or group of notes within the specified measures of a selected track. A single note (for example, C3) or all notes between a range you specify (for example, C3 to G3) can be edited. Set the note or note range to be edited by holding down the desired note, or the beginning and ending notes of the range you want to set, and then pressing the NOTE button. Press one note and only that note will be edited. Press two notes and those two notes, and all notes in-between, will be edited. After the note or notes have been specified, the NOTE indicator will light, indicating that those notes are set to EDIT. Press the NOTE button a second time (the indicator will turn off) and the note or notes specified will be canceled. If no note is specified, all notes will be applicable for Edit.

■ EDITING

● QUANTIZE

A measure of 1/8th notes before quantizing.



A measure of 1/8th notes after quantizing.



1. Specify the measures you want to QUANTIZE, then enter the QUANTIZE mode

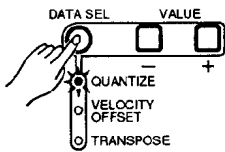

Specify the measures you want to QUANTIZE using the EDIT Starting point/Ending point method described on page 54. Then press the DATA SEL button and light the QUANTIZE indicator.

* The mode changes with each press of the DATA SEL button.

2. Select the QUANTIZE value.

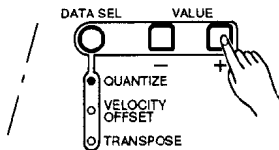

Use the VALUE +/- buttons to set a QUANTIZE value between 4 and 192 in the center digital display (There are 10 QUANTIZE value levels: refer to the table below).

NOTE: The QUANTIZE value adjusts the timing of each note event between the specified measures to the nearest interval of the specified value. For example, if both 1/8th and 1/16th notes are present, the QUANTIZE value should be set to 16 (Quantizing to 8 will move 1/16 notes to the next 1/8th note interval).

QUANTIZE VALUE table

4 (1/4)	1/4 note	32 (1/32)	1/32 note
8 (1/8)	1/8 note	48 (1/48)	1/32 note triplet
12 (1/12)	1/8 note triplet	64 (1/64)	1/64 note
16 (1/16)	1/16 note	96 (1/96)	1/64 note triplet
24 (1/24)	1/16 note triplet	192 (1/192)	1/128 note triplet

* It is impossible to set QUANTIZE to values that fall between those listed above.

3. QUANTIZE

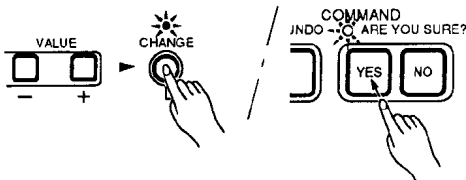

After a QUANTIZE value has been set, press the CHANGE button located to the right of the VALUE +/- buttons, and the ARE YOU SURE? indicator will flash. Press the YES button, and the QUANTIZE operation will begin. (Press the NO button or the CHANGE button once again to cancel the QUANTIZE operation.) The CHANGE indicator will flash during the operation, then light when the operation is completed. (And the FROM, TO, and NOTE indicators will switch off.)

* QUANTIZE operation can be undone by pressing the UNDO button while the UNDO indicator flashes.

NOTE: If you finely quantize (use a large QUANTIZE value) roughly quantized (small QUANTIZE value) data, that data cannot be returned to its original form.

NOTE: Since both Key On and Key Off are quantized, Key On and Key Off occur simultaneously. This causes compressed sound production in some cases. Correct this by shifting Key Off back a small amount.

5. SEQUENCER

● VELOCITY OFFSET

1. Specify the measures to which you want to apply VELOCITY OFFSET, then enter the VELOCITY OFFSET mode.

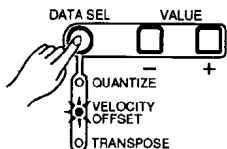

This operation modifies the Velocity value for all note events within the specified measures.

Specify the measures to which you want to apply VELOCITY OFFSET using the EDIT Starting point/Ending point method described on page 54. Press the DATA SEL button and light the VELOCITY OFFSET indicator.

2. Select the VELOCITY OFFSET value.

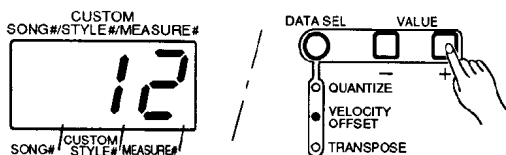

Use the VALUE +/- buttons to set a VELOCITY OFFSET value between -127 and 127 (MIDI data values) in the center digital display. Apply this VELOCITY OFFSET value to all Key ON data within the set Edit range.

* Simultaneously press the VALUE + and - buttons to reset the VELOCITY OFFSET value to 000.

3. Execute VELOCITY OFFSET

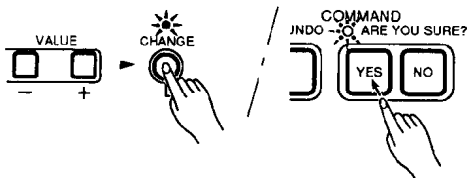

After the VELOCITY OFFSET value has been set, press the CHANGE button located to the right of the VALUE +/- buttons, and the ARE YOU SURE? indicator will flash. Press the YES button to start the VELOCITY OFFSET operation. (Press the NO button or the CHANGE button once again to cancel VELOCITY OFFSET.) The CHANGE indicator will flash during the operation, then light when the operation is completed. (And the FROM, TO, and NOTE indicators will switch off.)

* VELOCITY OFFSET operation can be undone by pressing the UNDO button while the UNDO indicator flashes.

NOTE: Use VELOCITY OFFSET values -127 through 127 to adjust velocity data between its minimum and maximum levels. However, after VELOCITY OFFSET is applied, any data value which exceeds 0 or 127 will automatically be set as 0 or 127.

● TRANSPOSE

This operation transposes all notes within the specified measures.



1. Specify the measures you want to transpose, then enter the TRANSPOSE mode

Specify the measures you want to TRANSPOSE using the method described on page 54. Then press the DATA SEL button and the TRANSPOSE indicator will light.

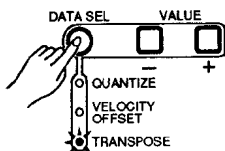

2. Select the TRANSPOSE value

Use the VALUE +/- buttons to set the TRANSPOSE value between -36 and 36 (+/- 3 octaves, one increment = one semitone) in the center digital display.

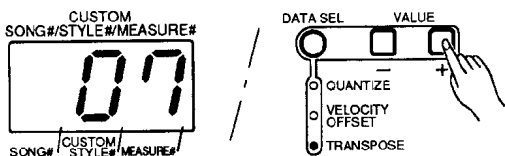

* Simultaneously press the VALUE + and - buttons to return the TRANSPOSE value to 00.

3. Execute TRANSPOSE

After the TRANSPOSE value has been set, press the CHANGE button located to the right of the VALUE +/- buttons, and the ARE YOU SURE? indicator will flash. Press the YES button to begin the TRANSPOSE operation. (Press the NO button or the CHANGE button once again to cancel the TRANSPOSE operation.) The CHANGE indicator will flash during the operation, then light when the operation is completed. (And the FROM, TO, and NOTE indicators will switch off.)

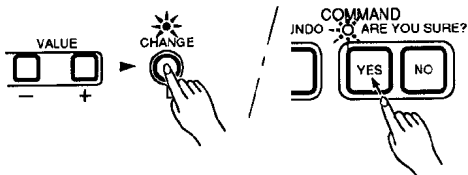

* This TRANSPOSE function also affects percussion, since transpose rewrites Key note numbers and data. Use this function to change percussion voice.

* TRANSPOSE operation can be undone by pressing the UNDO button while the UNDO indicator flashes.

5. SEQUENCER

● CLEAR

This operation replaces all data within the specified measures with blank measures.

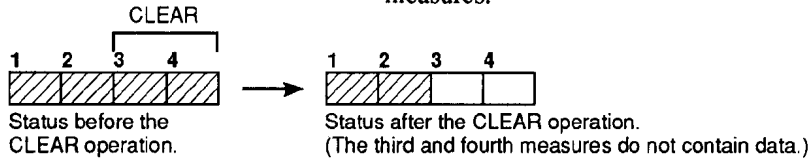

1. Specify the measure numbers you want to CLEAR

Specify the measures you want to CLEAR using the EDIT Starting point/Ending point method described on page 54.

NOTE: Be aware that if several tracks are selected to CLEAR, all data within the specified measures of all selected tracks will be erased.

NOTE: If measure numbers are not specified, all data of all currently selected tracks will be erased when the CLEAR button is pressed.

2. Execute CLEAR

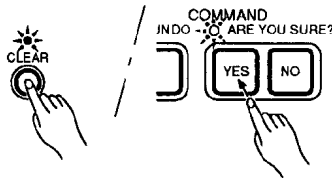

After the measure numbers have been specified, press the CLEAR button, and the ARE YOU SURE? indicator will flash. Press the YES button to begin the CLEAR operation. (Press the NO button or the CHANGE button once again to cancel the CLEAR operation.) The CHANGE indicator will flash during the operation, then switch off when the operation is completed. The FROM, TO, and NOTE indicators will also switch off when the operation is completed.

* Hold down the CLEAR button and press the STOP button to erase all data in all tracks.

* Delete the data in the specific track by holding down the CLEAR button and pressing the SEQUENCER button of that track.

● COPY

This operation copies a specified range of measures, then places the data in the PSR-SQ16 edit buffer. Data in the edit buffer can then be placed into any track by using the INSERT function or the PASTE function (mixing the data in the edit buffer with the data already there).

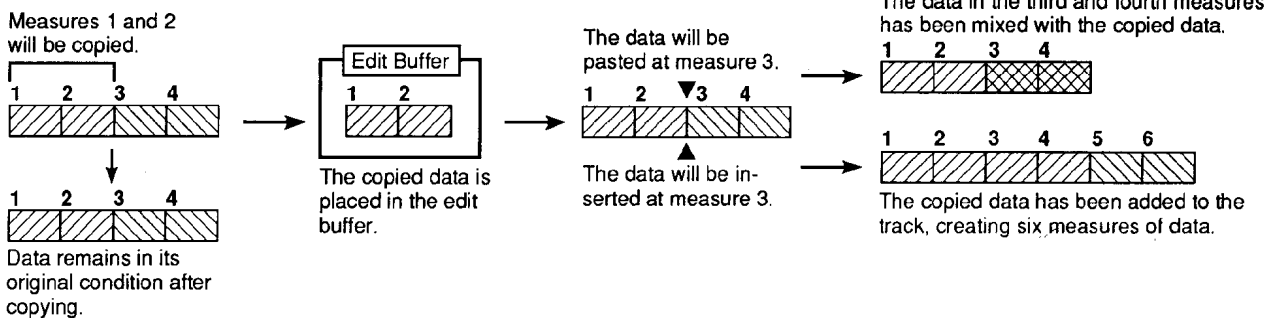

1. Specify the measures you want to COPY

Specify the measures you want to COPY by using the EDIT Starting point/Ending point method described on page 54.

NOTE: If no measure numbers are specified, all currently selected tracks will be copied when the COPY button is pressed.

2. Copy the source data to be stored in the edit buffer.



After the measures have been specified, press the COPY button, and the ARE YOU SURE? indicator will flash. Press the YES button and the specified data will be copied and placed in the edit buffer. During this operation the COPY button's indicator will flash, then switch off when the operation is completed. The FROM, TO, and NOTE indicators will also switch off when the operation is completed, and the PASTE and INSERT indicators will light.

3. Execute the PASTE or the INSERT operation.

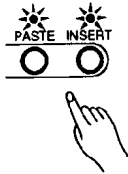

While the PASTE and INSERT indicators are lit, you can PASTE (mixing the data in the edit buffer with the data already there) or INSERT data from the edit buffer into Sequencer tracks. Use the PLAY, FORWARD, or REWIND buttons to specify (in the center digital display) to which measure number data will be PASTED or INSERTED. Next, specify the destination track. Then, press the PASTE button or the INSERT button, and the ARE YOU SURE? indicator flashes. Press the YES button to execute the PASTE or INSERT operation.

NOTE: The edit buffer has only one memory allocation. New copied or cut data will replace old data in the edit buffer.

NOTE: When PASTING, the amount of destination tracks should match the amount of source tracks. If they do not match and PASTE is executed, the error message "SE0" appears in the center digital display. When INSERTING, copied tracks are inserted in the specified track, and blank data is inserted in the same position to other tracks in the same Song.

NOTE: Paste to a track that does not contain any recorded data by pressing the PASTE button, and then, while the ARE YOU SURE? indicator is flashing, press the button of the track you want to paste to.

● CUT

This operation deletes specified measures and places the data in the PSR-SQ16 edit buffer. The measures that remain will then move up to fill the gap, for all the tracks. Data in the edit buffer can then be put into any track with the INSERT function or the PASTE function (mixing the data in the edit buffer with the data already there).

Measures 1 and 2 will be cut.

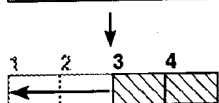
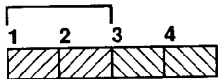

After cutting, the remaining measures move up to fill the gap.

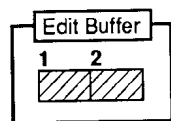

The cut data is placed in the edit buffer.

The data will be pasted at measure 3.

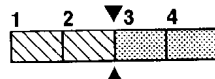

The data will be inserted at measure 3.



The data in the third and fourth measures has been mixed with the copied data.

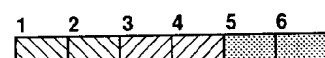
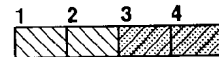

The CUT data has been added to the track, creating six measures of data.

1. Specify the measures to be CUT

Specify the measures you want to CUT using the EDIT Starting point/Ending point method described on page 54.

NOTE: If no measure numbers are specified, all currently selected tracks will be cut when the CUT button is pressed.

NOTE: When CUTTING, all data between FROM and TO is deleted, regardless of the specified Track and Note, and placed in the Edit buffer.

5. SEQUENCER

2. CUT data is immediately copied into the edit buffer.



After the measures have been specified, press the CUT button, and the ARE YOU SURE? indicator will flash. Press the YES button and the specified data will be cut and placed in the edit buffer. The CUT indicator will flash during this operation, then light when the operation is completed. The FROM, TO, and NOTE indicators will switch off when the operation is completed, and the PASTE and INSERT indicators will light.

3. Execute the PASTE or INSERT operation.

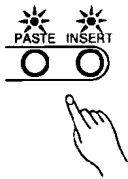

While the PASTE and INSERT indicators flash, data in the edit buffer can be PASTED (mixing the data in the edit buffer with the data already there) or INSERTED into sequencer tracks. Use the PLAY, FORWARD, or REWIND buttons to specify (in the center digital display) which measure number data will be PASTED or INSERTED to. Then, press the PASTE button or the INSERT button, and the ARE YOU SURE? indicator will flash. Press the YES button to execute the PASTE or INSERT operation. This position is where Paste or Insert starts.

NOTE: The edit buffer has only one memory allocation. New CUT or COPIED data replaces old edit buffer data.



NOTE: While the UNDO lamp flashes, the CUT and INSERT operations can be undone (data can be returned to its pre-edited form).

NOTE: In sequencer, if a large amount of data is processed at one time, a delay in sound generation may result. If this is the case, shift each data position a little to make the sound generation smooth.

(Example)

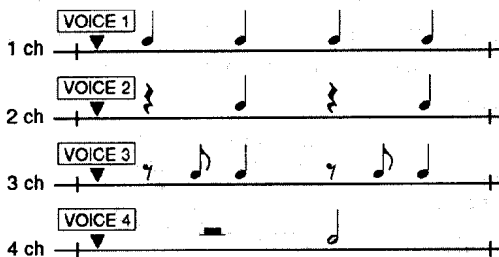

The sound generation of Channel 1 is delayed because voice changes occur simultaneously.

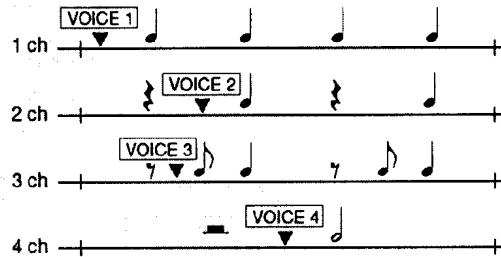

Shift the voice change timing as shown above, to make sound generation smooth.

● Sequencer Error Messages



Incorrect Operation
An improper operation has been performed.



Copy Buffer Full
Data too large for the Edit buffer has been CUT or COPIED.



Too Much Data
There is too much data to be played back at the same time



Memory Full
This displays when the available Sequencer memory is smaller than the data to be loaded.

CUSTOM STYLE

You can create original Accompaniment styles with the CUSTOM STYLE function. You can create totally original CUSTOM STYLES, or edit one of the Auto Accompaniment styles from the preset library. The 8 CUSTOM STYLES are stored internally and are assigned CUSTOM STYLE numbers 269 through 276. These CUSTOM STYLES can also be saved to a floppy disk. Use the following basic procedure to create a CUSTOM STYLE from a preset style.

■ Creating a CUSTOM STYLE from a preset style.

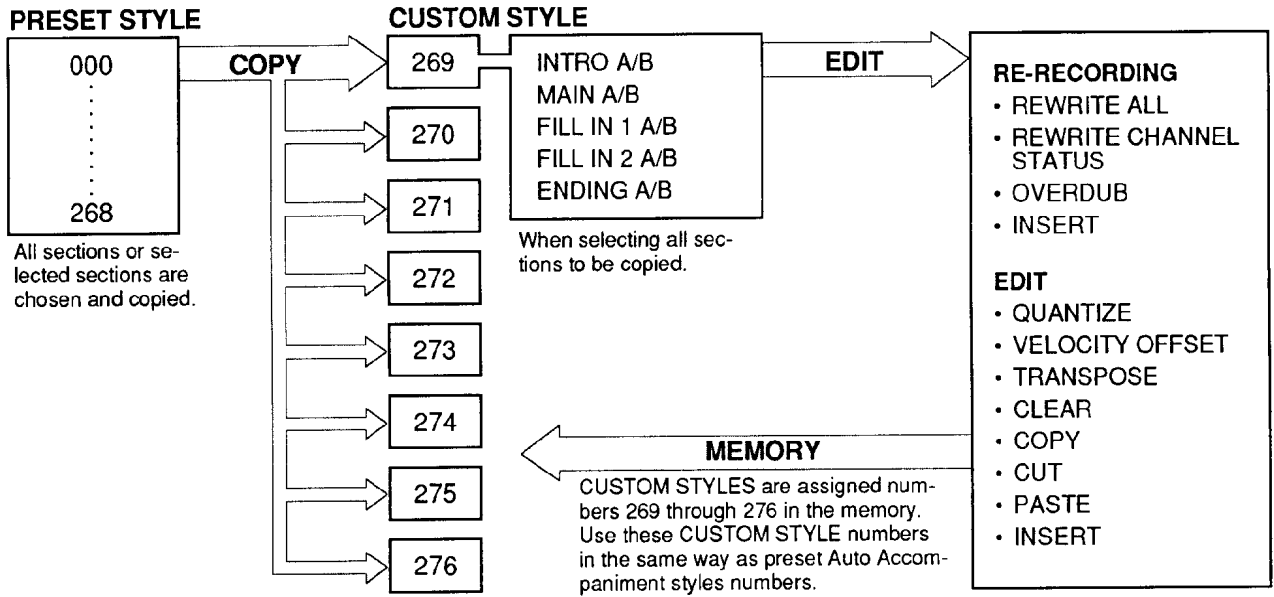

* Part Accompaniments and Rhythm Style contain only MAIN A section performance data. Create other original sections on your own.

As an example, let's copy Auto Accompaniment style 033 into CUSTOM STYLE 269, and make an original CUSTOM STYLE.

1. Enter the CUSTOM STYLE mode.

Press the CUSTOM STYLE ON button to select the Custom Style mode, and the center digital display will display the Custom Style number.

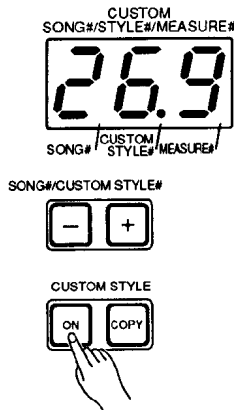

CUSTOM STYLE

2. Select Custom Style No.

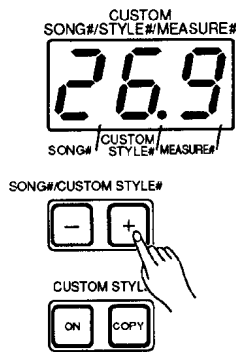

Use the SONG#/CUSTOM STYLE# +/- buttons below the center digital display to select a CUSTOM STYLE number between 269 and 276, and the ARE YOU SURE? indicator will flash. Press the YES button to set the CUSTOM STYLE number. For our example, select style number 269.

If there is already data in the CUSTOM STYLE, "F" and the style number will flash alternately. If there is no data, "- ." and the style number will flash alternately.

3. Select the source style to be copied.

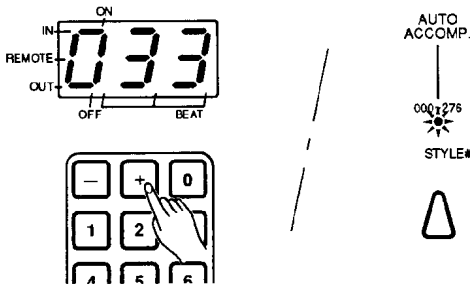

Use the Auto Accompaniment's "Select a Style" operation on page 18 of the Basic Operation section to select a source style for the CUSTOM STYLE. For our example, select 033 Heavy Metal.

4. COPY the style

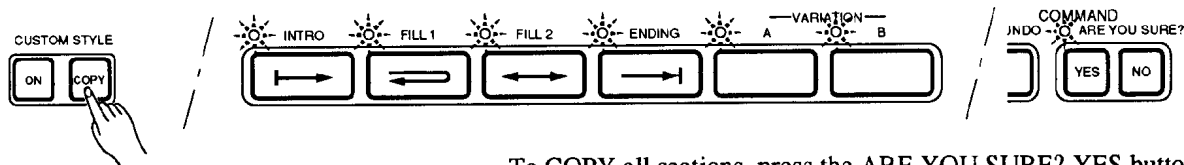

Press the COPY button to prepare for copying the Auto Accompaniment Style.

To COPY all sections, press the ARE YOU SURE? YES button. To COPY one section, press the desired section button, and its indicator will light. (For example, press the VARIATION A button to copy the MAIN A section. Or, press the ENDING and Variation B buttons to copy the ENDING B section.) Then, press the ARE YOU SURE? YES button to copy the Accompaniment Style into the selected CUSTOM STYLE number.

NOTE: Only all or one track can be copied at one time. If you want to copy a different number of tracks, copy each track separately.

NOTE: It is possible to copy different sections from different styles.

NOTE: When a Part Accompaniment or Rhythm Style is selected and the COPY button is pressed, only the VARIATION A and ARE YOU SURE? indicators will flash. This is because Part Accompaniment and Rhythm style only contain data for the MAIN A section (refer to the Basic Operation section, page 16). Full Accompaniment styles, such as Accompaniment 033, contain data for all Accompaniment Sections.

5. EDIT the COPIED Style

Copied Custom Style data can be used the same as Sequencer data. Therefore Recording operations (refer to page 48) and Edit operations (refer to page 53) can be executed. Your imagination and the editing techniques are your only limits in creating original CUSTOM STYLES.

NOTE: While in the CUSTOM STYLE mode, Sequencer tracks 1 through 9 cannot be recorded to or played back.

● Basic editing techniques (For example: Full Accompaniment)

1. Select the SECTION

When a Full Accompaniment style is copied into a CUSTOM STYLE number, all section data (the INTRO, MAIN, FILL 1 and 2, and ENDING sections of each A and B Variation) is present. Press a section button and that section's performance data will be sent to the panel. (The selected section's indicator will light, along with the indicators of the Sequencer tracks that hold performance data.)

2. Select the track

When you listen to full playback or playback of individual tracks, listen carefully to what is on each track. When you EDIT, it is best to start with the rhythm track, then the bass track, and finally the chord tracks. Therefore, light the indicator of the rhythm track, and its corresponding KEYBOARD CHANNEL, first.

3. Editing

Edit the rhythm track. Refer to the Sequencer's RECORDING or EDIT sections (on pages 48 and 53 respectively), then try changing the percussion parts (refer to OVERDUB, page 48). Next, try changing the Volume or Pan, along with the other Channel Status parameters (refer to REWRITE CH STATUS, page 48). The COPY and PASTE/INSERT operations can also be used. Use these operations to first edit the style of the rhythm, then go back and edit the bass track and chord tracks. Using the REPEAT function explained in the following paragraph makes editing easier.

Use procedures 1 through 3 along with your imagination to create an original CUSTOM STYLE.

● REPEAT recording

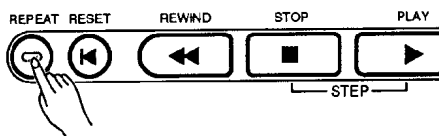

After you begin recording the CUSTOM STYLE, press the REPEAT button and playback will continuously repeat, from the measure where you start recording to the end of the measure in which the REPEAT button was pressed. Use this function with the OVERDUB mode when you play a new rhythm, and that rhythm will be recorded when the track repeats.

6. Using a CUSTOM STYLE

8 CUSTOM STYLES total, made with the above recording procedure, can be stored the same as Sequencer data in the internal memory. After exiting the CUSTOM STYLE mode, use Accompaniment Style numbers 269 through 276 the same as preset Auto Accompaniment styles.

NOTE: If you want to create a totally new CUSTOM STYLE, select an Accompaniment section. Then use then Sequencer recording operations (refer to page 44) and record a new style.

NOTE: When creating new styles, make them in the C Major7 chord. The PSR-SQ16 can automatically convert these C Major7 chord styles into other chord styles.

A wide range of PSR-SQ16 functions can be controlled by connecting a foot pedal.

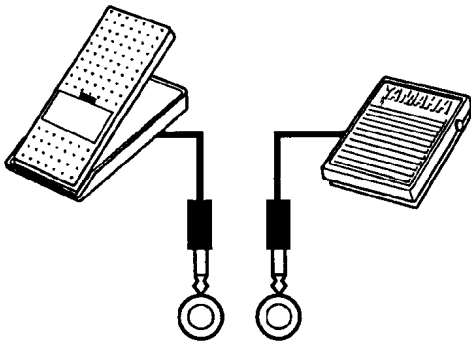
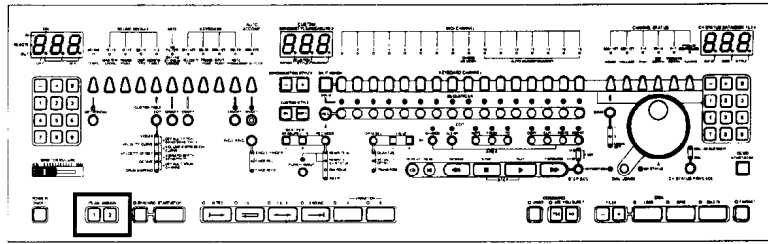

2 — 1
PEDAL

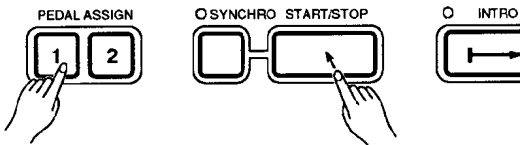

Assigning the START/STOP function to a pedal.

● Functions that can be assigned to the foot pedal.

Switchable functions that can be assigned to the FOOT PEDAL. (Use the optional FC4 or FC5 pedal.)

- | | |
|-------------------------|--------------------|
| • VOICE | • RESET |
| • METRONOME | • REWIND |
| • NOTE PROCESSOR ON/OFF | • PLAY |
| • AUTO ACCOMP. ON/OFF | • PUNCH IN |
| • INTRO | • STOP |
| • FILL 1 | • FORWARD |
| • FILL 2 | • REPEAT |
| • VARIATION A/B | • KEYBOARD CHANNEL |
| • ENDING | • FINGERED 2 |
| • START/STOP | • STEP SIZE |
| • SYNCHRO | |

Functions that can be assigned to the FOOT CONTROLLER. (Use the optional FC7 foot controller.)

- | | | |
|----------|-------------|-----------------|
| • TEMPO | • PAN | • VIBRATO DEPTH |
| • VOLUME | • DSP DEPTH | • TUNING |

* Sustain and Expression are also activated, even though they are not panel functions.

The PEDAL 1 and PEDAL 2 jacks at the rear panel of the PSR-SQ16 are for connecting an optional foot switch (YAMAHA FC4 or FC5) and foot controller (YAMAHA FC7). After connecting the foot pedals to these jacks, hold down the PEDAL ASSIGN 1 or PEDAL ASSIGN 2 button, then press the function you want to assign to the foot pedal. The foot pedal can then perform the same functions as the selected button. The PEDAL ASSIGN 1 button corresponds to the PEDAL 1 jack and its connected foot pedal or switch, and the PEDAL ASSIGN 2 button to the PEDAL 2 jack.

- * If the FOOT SWITCH is connected, but no function has been assigned to it, Pedal 1 acts as a Sustain, and Pedal 2 acts as an Expression. If the FOOT SWITCH is currently assigned to a PSR-SQ16 panel function, you can return it to the Sustain or Expression function by depressing the FOOT SWITCH while holding down the PEDAL ASSIGN button.
- * Reverse the FOOT SWITCH'S ON/OFF function by pressing the PEDAL ASSIGN button twice rapidly. Reverse the relationship between the pedal depressing angle and the ON/OFF effect of the foot controller in the same way. Also, because the FOOT SWITCH and FOOT CONTROLLER have opposite polarities, this method can be used to adjust the polarities in order to attain easier operation.
- * When a FOOT SWITCH is used to control Channel Status functions, Channel Status amounts change from the minimum to the maximum. You can also use the FOOT CONTROLLER to control ON/OFF of the PSR-SQ16's switch functions.
- * To select KEYBOARD CHANNELS with the FOOT SWITCH, hold down either the PEDAL ASSIGN 1 button or PEDAL ASSIGN 2 button, then press any KEYBOARD CHANNEL button. If Channel selection is assigned to PEDAL 1, pressing the FOOT SWITCH selects the KEYBOARD CHANNEL to the left. Pressing PEDAL 2 selects the KEYBOARD CHANNEL to the right.
- * To assign VOICE alteration to the FOOT SWITCH, hold down either the PEDAL ASSIGN 1 or PEDAL ASSIGN 2 button, then press the VOICE button. If VOICE alteration is assigned to PEDAL 1, pressing the FOOT SWITCH decreases the Voice number by one, and if assigned to PEDAL 2, the Voice number increases by one.
- * To assign the FINGERED 2 mode to the FOOT SWITCH, hold down either the PEDAL ASSIGN 1 or PEDAL ASSIGN 2 button, then press the FINGERING button. Then if you press the FOOT SWITCH while the Auto Accompaniment is playing in the FINGERED 1 mode, the Auto Accompaniment will switch to the FINGERED 2 mode for as long as you hold down the FOOT SWITCH.
- * When Volume or Expression is assigned to the Foot Controller, step noise (noise from step by step volume fluctuation) can be noticeably heard in some voices. This is due to Volume's resolution limitation.
- * Pedal Assign setting is recorded for each song. If the new Song number is selected, the new Pedal Assign setting will also be recalled.

7 TEMPO

This controls overall tempo of the PSR-SQ16. Auto Accompaniment, the Note processor, and the Sequencer are also controlled by this TEMPO.

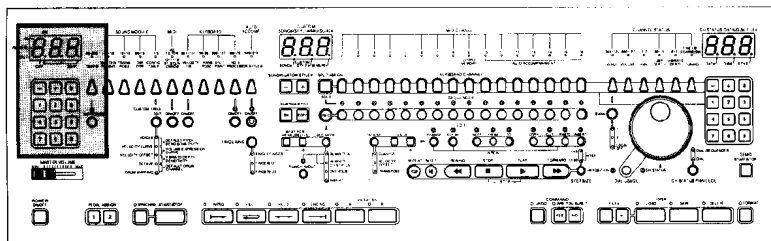

● Change the Tempo

40-240
TEMPO



Press the TEMPO button, and its indicator will light. Use the +/- buttons or numeric buttons below the left-hand digital display to set a TEMPO value between 40 and 240.

NOTE: If you change Auto Accompaniment styles while the rhythm is stopped, the new style's default tempo is automatically set. However, if you change styles while the rhythm is playing, the tempo will not change.

NOTE: Press the Sequencer PLAY or RESET button, or change the Song number or Custom Style number, and the tempo recorded in the Sequencer will be set.

● Play Metronome



Press the METRONOME button, and its indicator will light. The metronome will start when the rhythm of Auto Accompaniment begins.

NOTE: Metronome sound is not recorded, or transmitted from MIDI OUT.

* Tempo and Metronome ON/OFF can be assigned to the PEDAL. For more information, refer to "Pedal Assign" on page 64.

■ About Floppy Disks

To playback Sequencer and Custom Style data, the PSR-SQ16 must first load recorded Sequencer and Custom Style data into its internal memory (RAM). However, the size of the memory is limited, so the amount of information (Songs or Custom Style data) you can store there is also limited. In addition, unplugging the PSR-SQ16 from its AC source while it is still ON will result in the loss of data stored in the RAM memory. For these reasons floppy disks are used as a medium for saving data. However, a floppy disk is not like a cassette tape in that information cannot be recorded directly to or accessed directly from a floppy. The floppy's function is to save music data created on the PSR-SQ16, and to load music data into the PSR-SQ16 for playback.

■ About PSR-SQ16 Files

Every Song and Custom Style data recorded into the PSR-SQ16 is saved as a single unit called a File. The PSR-SQ16 is capable of creating and saving to a floppy a maximum of 99 Files. However, the number of Files that can actually be created depends upon the memory size of each File. The PSR-SQ16's internal RAM memory holds a total of 120 kilobytes of data. One 3.5 inch floppy disk holds a total of 720 kilobytes. Therefore, a floppy disk can hold 6 times the amount of data that the PSR-SQ16's memory can hold. When the PSR-SQ16 saves a File to a floppy disk, it automatically assigns that File a file number.

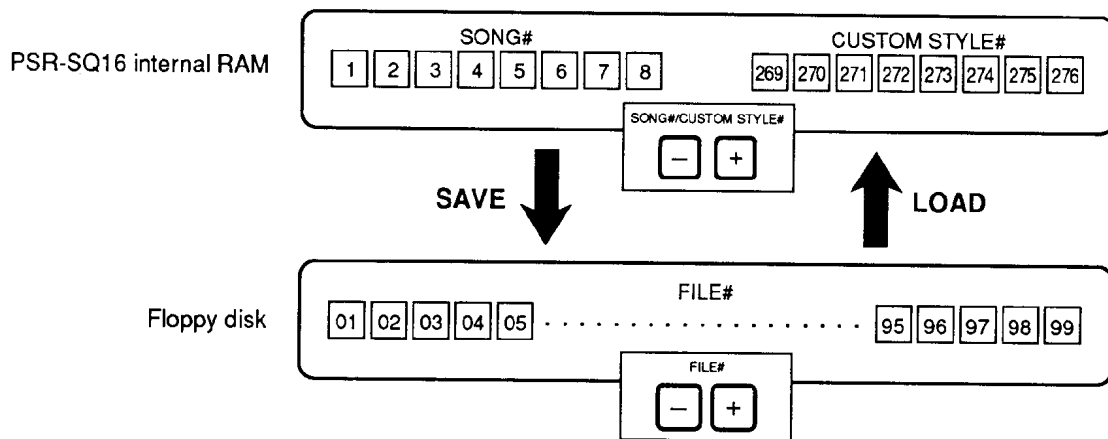

* FILE names saved to a disk are automatically given an extension by the PSR-SQ16, like this: "PSR_XYY.MID". X is the File type. If X=S it means Song number, and if X=A it means Custom Style file (Accompaniment). YY is the File number, 01 through 99.

● PSR-SQ16's disk data handling

- Song data and the Configuration Table (refer to page 77) recorded into the Sequencer are combined and stored in the same File number (Song File).
- Each Custom Style data recorded into the sequencer is saved as one File Number (Custom Style File).

■ About Floppy disk compatibility

The following two factors must be considered when using PSR-SQ16 floppy disks with computers or other devices.

1. Disk Format

If the disk format is the same for both devices, data can be used directly without any modification. The PSR-SQ16 uses the MS-DOS format which makes it compatible with the following systems. (Floppy disks must be 3.5 inch 2DD type.)

IBM-PC, NEC-PC9801 series, Apple-Macintosh, Atari 1040STF, and Atari 1040STE.

NOTE: Apple-Macintosh format disks are compatible with the PSR-SQ16 only if they are formatted as IBM-PC disks using a Macintosh with a Super Drive and "Apple File Exchange", or similar utility software.

NOTE: Only Atari format versions 1040STF TOS 1.4 or greater, and 1040STE TOS 1.6 or greater, can read PSR-SQ16 data. However, data written by the Atari cannot be read by the PSR-SQ16.

2. File Format

The PSR-SQ16 also supports the file formats listed below.

		SAVE	LOAD
STANDARD MIDI FILE (ver. 1.0)	FORMAT 0	○	○
	FORMAT 1	X	○
ESEQ FILE FORMAT		X	○

NOTE: The PSR-SQ16 file extension of the "Standard MIDI File" file name should be .MID. Use a computer to change any file whose extension is something other than .MID.

NOTE: To use data saved by the PSR-SQ16 on an Apple-Macintosh, adapt the file attribute in the Type and Creator function to that of your application software by using "ResEdit" or similar utility software.

NOTE: The PSR-SQ16 can load ESEQ File format, regardless of the file name, although it saves that file as PSR__XYX.MID in Standard MIDI File format.

- * MS-DOS is a registered trademark of Microsoft Corporation.
- * IBM-PC is a registered trademark of International Business Machines corporation.
- * NEC-PC9801 series is a registered trademark of NEC corporation.
- * Apple-Macintosh is a registered trademark of Apple Computer, Inc.
- * Macintosh, Apple File Exchange, and ResEdit are registered trademarks of Apple Computer, Inc.
- * Atari is a registered trademark of Atari Computers.

● About the Standard MIDI File Format

The Standard MIDI File Format is a standard which has recently been implemented by a number of software and hardware makers that allows song data to be easily transferred between Sequencers made by different manufacturers.

There are three Standard MIDI File types. The PSR-SQ16 supports format 0 and format 1.

Format 0 : Sequencer data is recorded in a single track which can hold up to sixteen MIDI channels.

Format 1 : Sequencer data is recorded in an unlimited number of tracks, each of which can hold up to sixteen channels.

8. DISK

● About loading format 1 Standard MIDI Files

Format 0 files may be loaded and used as they are. However, because format 1 files employ multiple tracks, each of which can hold up to sixteen channels, data cannot be used as it is. The PSR-SQ16 combines the data of each track assigned the same channel number together, and converts format 1 files to format 0 files.

● About ESEQ file format

The ESEQ File Format is Yamaha's original file format which makes the PSR-SQ16 compatible with many other Yamaha products.

- The following Yamaha products use the ESEQ file format.
QX3
DOC Software (Disk Orchestra Collection) for the Clavinova.
Disklavier System.

NOTE: Data such as Key on, Key off, velocity, program numbers, etc., are all compatible between systems. However, this doesn't mean 100% reproduction of original sounds on the other systems. To reproduce original data more precisely, use the Configuration Table (refer to page 77) to make detailed adjustments not covered by the MIDI standard to the tone generator. Also, because nuances differ between voices, playback will sound different from the original data. Listen and make adjustments to the voices as needed.

● Directory, File name

- The PSR-SQ16 can only use those files which are in the MS-DOS root directory.
- Although it is possible for the PSR-SQ16 to read non PSR-SQ16 formatted data (PSR __ XYX.MID), .MID should be used for the Standard MIDI file extension. The PSR-SQ16 assigns sequential file numbers based on the succession in which they are saved under MS-DOS.

● Files of the configuration table and condition setup

To properly playback song file data created with the configuration table (except for 1, default), the configuration table file is required. When playing back, if you want to play under the same panel setting conditions as when you recorded, a condition setup file is required. When saving song data created with the PSR-SQ16, the configuration table file (refer to page 77) is automatically created and stored at the end of the standard MIDI file data as exclusive data. When loading this song data, all data is automatically recalled together. To create data with an external sequencer or computer, first create a file with configuration and condition setup by saving a Song that has no data, and then create data by using the Song that you've saved. Another method would be to load data created with a separate device into the PSR-SQ16. Match the configuration setting and other panel settings and save that data, and a file with configuration and condition setup will be created.

NOTE: If you load a Song file that does not contain a Configuration file, the previous Configuration table will be used.

NOTE: If you load a Song file that does not contain a condition setup file, the previous condition setup will be used.

NOTE: Configuration table and condition setup files function only when loaded from a disk. If this data is transmitted to the PSR-SQ16 from an external data filer or sequencer, it will not be accepted.

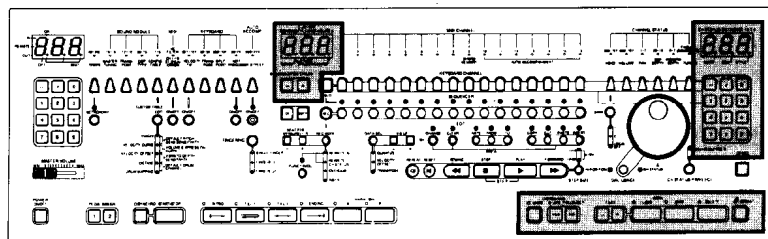

FORMATTING (Initializing)

Before a new disk can accept PSR-SQ16 data, it must be formatted in the procedure explained below.

- 1. Insert the floppy disk into the disk drive (Make sure that the disk's shutter faces the drive slot and that the label faces up).**

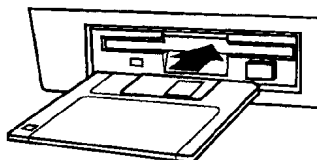

* If you are not sure whether the disk has been formatted already, insert the disk into the disk drive and press the FILE # +/- button. If the disk has not been formatted "dE1" will appear in the right-hand digital display.

- 2. Format the disk**

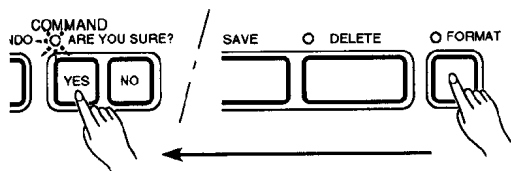

Disk In Use Indicator

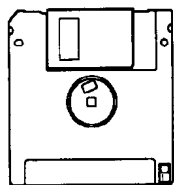
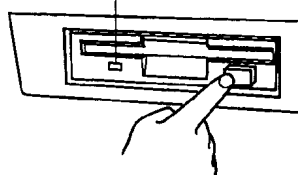

Write Protect Tab

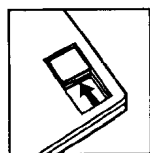

Write Protect OFF

Press the FORMAT button and the ARE YOU SURE? indicator will flash. Press the YES button and the PSR-SQ16 will start formatting the disk. During the formatting operation, the indicator FORMAT button is lit, and the "disk in use" indicator located below the disk drive slot is flashing. The right-hand digital display will show the progress of the formatting operation by counting down from dF8 to dF0.

When the format operation has finished, both indicators will go off and the right-hand digital display will return to the CHANNEL STATUS mode.

Eject the floppy disk from the disk drive by pressing the "eject" button slowly and completely. Remove the disk by hand only after it has fully ejected.

NOTE: Never remove the floppy disk while the "disk in use" indicator is flashing.

NOTE: To protect data, turning off the PSR-SQ16's power will have no effect during format and load/save operations.

NOTE: A floppy disk whose write protect tab is locked cannot be formatted. Make sure the write protect tab is unlocked before you format a floppy.

NOTE: Error messages are described in the ERROR MESSAGE LIST (refer to page 74).

NOTE: Any data stored on a disk is erased during formatting.

8. DISK

SAVE

How to save performance data recorded on the PSR-SQ16.

1. Insert a formatted disk into the disk drive.

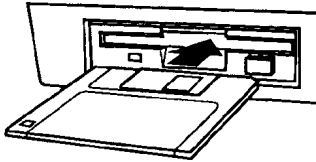

2. Select the FILE (Song/Custom Style) to be saved.



Select the File number to be saved by using the SONG #/CUSTOM STYLE # +/- buttons. When the ARE YOU SURE? indicator flashes, press the YES button to confirm your selection. Select a Custom Style number by pressing the CUSTOM STYLE ON button, then pressing the SONG #/CUSTOM STYLE # +/- buttons. When the ARE YOU SURE? indicator flashes, press the YES button to confirm your selection. (Whether Song or Custom Style files are displayed is indicated by the "dots" on the bottom of the center digital display.)

3. Select the disk's File number.

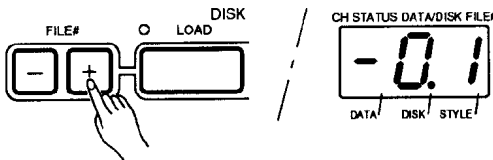

Press the FILE# +/- button once and the disk's File numbers will appear in the right-hand digital display. Use the FILE# +/- button to select a file number to which the song data will be saved.

- * File numbers containing data will be preceded by an "F". File numbers that have no data will be preceded by "-".
- * Press any Channel Status button to return the right-hand digital display to the Channel Status mode.

4. Save

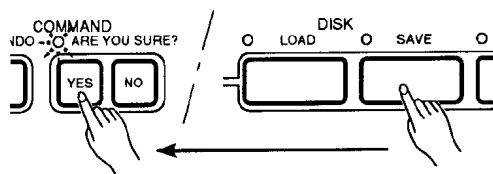

Press the SAVE button and its indicator will light, and the ARE YOU SURE indicator, the File number in the center digital display, and the disk File number in the right-hand digital display will all flash simultaneously. Press the YES button and saving will begin.

NOTE: The "disk in use" and SAVE indicators will flash during the SAVE operation, and the right-hand digital display will count down from dS9 to dS0. The figure counted down differs depending on the size of the file. Never remove the disk at this time or data may be lost or destroyed.

NOTE: The error message "dE7" appears in the right-hand digital display when there is not enough memory on the floppy to store the data. Solve this by deleting any unnecessary information on the disk or save the new file into an unused file on the disk by selecting and overwriting the unused file. If the error message persists, use a new floppy disk.

NOTE: Error messages are described in the ERROR MESSAGE LIST (refer to page 74).

LOAD

Loading performance data from a floppy disk to the PSR-SQ16.

1. Insert the floppy disk into the disk drive.



Insert the floppy disk containing data into the disk drive.

2. Select the disk's file number.

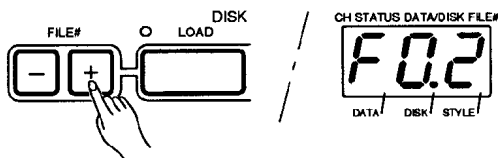

Press the FILE# +/- button once and the disk's File numbers will appear in the right-hand digital display. Select the File number of the song data to be loaded using the FILE# +/- button.

- * File numbers containing data will be preceded by an "F". File numbers that have no data will be preceded by "-".
- * Press any Channel Status button to return the right-hand digital display to the Channel Status mode.

3. Load a file by selecting the Song # or CUSTOM STYLE #.



Song# number

Select a Song# number to load disk data by using the SONG#/CUSTOM STYLE# +/- buttons. When the ARE YOU SURE? indicator flashes, press the YES button to confirm your selection.

Custom Style# number

Select a Custom Style# number to load disk data. To do this, press the CUSTOM STYLE ON button, then press the SONG#/CUSTOM STYLE# +/- buttons. When the ARE YOU SURE? indicator flashes, press the YES button to confirm your CUSTOM STYLE # selection.

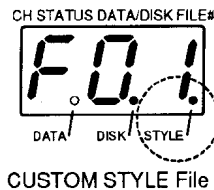
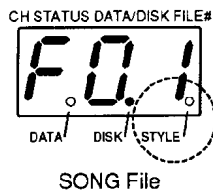

NOTE: Load Song files into SONG # files, and Custom Style data into CUSTOM STYLE # files. If you load Custom Style data into SONG # files, all sections will playback continuously. If you load Song files into CUSTOM STYLE # files, only data of Channel 10 through 16 will be loaded into VARIATION A section. The "dots" of the right-hand digital display will indicate which type of file on the disk is selected.

8. DISK

4. LOAD

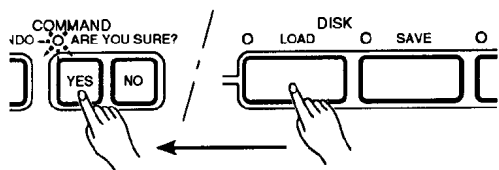

Press the LOAD button and its indicator will light, and the ARE YOU SURE? indicator, the File number in the center digital display, and the disk File number in the right-hand digital display will all flash simultaneously. Press the LOAD button and loading will begin.

As the file is loading, the right-hand digital display will count down from dL9 to dL0, indicating the progress of the operation. (The figure counted down differs depending on the file size. MAX 9.) Loading is complete when dL0 is displayed.

When loading is completed, the indicators of Sequencer tracks that contain data will be lit.

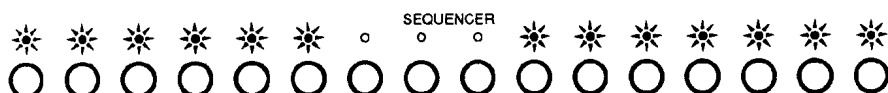

NOTE: If the file contains no data for loading, the right-hand digital display shows the disk error message "dE2".

NOTE: Loading data from the disk into a SONG # or CUSTOM STYLE # file number that already contains data will erase the earlier assigned data. If you want to keep this earlier assigned data, save it to a floppy disk, or load the disk data into an open SONG # or CUSTOM STYLE # file number.

NOTE: The "disk in use" and LOAD indicators will flash during the LOAD operation. Never remove the disk at this time, or data may be lost or destroyed.

NOTE: The resolution of the PSR-SQ16 sequencer is $\downarrow = 48$. The Song data or Custom Style data loaded from the disk is converted to this resolution during loading. In some cases, this may cause the resolution of the loaded Song data or Custom Style to differ from the original one.

DELETE

Delete performance data disk files. This function permanently deletes disk data.

1. Insert the floppy into the disk drive.

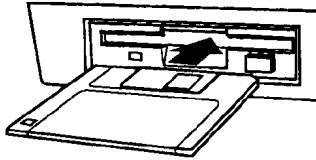

Insert a disk containing information into the disk drive.

2. Select the file number from the disk.

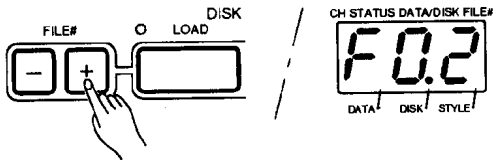

Press the FILE# +/- button once and the file numbers will appear in the right-hand digital display. Use the FILE# +/- button to select the file number of data to be deleted.

- * File numbers containing data will be preceded by an "F". Files with no data will be preceded by ".".
- * Press any Channel Status button to return the right-hand digital display to the Channel Status mode.

3. DELETE

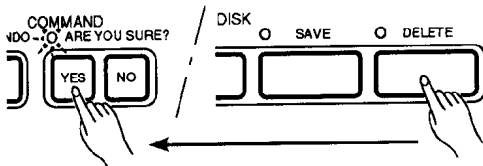

Press the DELETE button and its indicator will light, and the ARE YOU SURE? indicator and the disk File number in the right-hand digital display will both flash. Press the YES button and deleting will begin.

NOTE: If the file contains no data, the right-hand digital display shows the disk error message "dE2".

NOTE: The "disk in use" and DELETE indicators will flash during the DELETE operation. Never remove the disk at this time or all data may be lost or destroyed.

8. DISK

ERROR MESSAGE LIST

If an error occurs during disk operation, one of the following Error Messages will appear in the right-hand digital display. Refer to the list below for solutions to these errors.

Disk Error Message 0 No Disk.

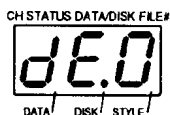

If you press the LOAD or SAVE button when there is no disk in the drive, this message will appear. Also, if you eject a disk during LOAD, SAVE, or FORMAT operations, this error message will appear.

⇒ Insert the disk into the drive and start the operation again.

Disk Error Message 1 ... Unformatted Disk.



If you insert an unformatted disk into the disk drive and press FILE# +/-, LOAD, SAVE, etc., this error message will appear.

⇒ You can either format the disk by pressing the FORMAT button (see FORMAT, page 69), or eject the disk and insert another disk that is already formatted.

Disk Error Message 2 No Data in the File.



If there is no data in the file and you press the LOAD or DELETE button, this error message will appear.

⇒ Select a file that contains data.

Disk Error Message 3 Memory Full.

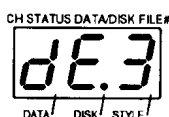

If the amount of data on a file to be loaded is too large for the memory space remaining in the PSR-SQ16, this error message will appear.

⇒ Delete unnecessary song data stored in the PSR-SQ16's internal memory or write the new data over it. If this error message still displays when all song data or custom style data has been deleted, then the file is too big for the PSR-SQ16's memory.

Disk Error Message 4 Load Error.



If you attempt to load data from a faulty disk (i.e. the disk is deformed or scratched) into the PSR-SQ16, this error message will appear. Data loaded up to the point of the error will be discarded, and data previously stored in the selected SONG # or CUSTOM STYLE # will also be lost.

⇒ Try loading data from the disk once again. If the same error occurs, then the problem is the disk. Use another disk and try again.

Disk Error Message 5Data Error.



If performance data that is not compatible with the PSR-SQ16 is loaded, this error message will appear. Data loaded up to the point of the error will be discarded, and data previously stored in the selected SONG # or CUSTOM STYLE # will also be lost.

- ⇒ Try loading the data from the disk once again. If the same error occurs, then the problem is the disk. Use another disk and try again.

Disk Error Message 6File Exists.



When you try to save data into a file that already contains data, this error message will appear.

- ⇒ If you wish to replace the old file with the new file, press the COMMAND (ARE YOU SURE?) YES button. If you want to save the new data using another file name, pressing the NO button will return the PSR-SQ16 to the File Select mode, where you can select a new File Number.

Disk Error Message 7Disk Full



If the data to be saved to a disk is too large for the memory space remaining on a disk, this error message occurs.

- ⇒ Overwrite to an unnecessary file on the disk, or delete the file and try the save operation again, or use another disk.

Disk Error Message 8Write Error

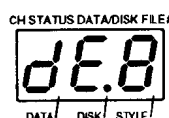

If an error occurs during a SAVE operation, this error message will appear.

- ⇒ Try saving the data on the disk once again. If the same error occurs, then the problem is the disk. Use another disk and try again.

Disk Error Message 9Write Protect

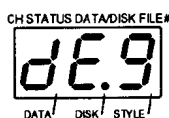

If the Write Protect tab of a disk is in the locked position, this message will appear.

- ⇒ Set the Write Protect tab to the unlocked position and try the operation again.

Disk Error Message FProtected File



If you try to SAVE or DELETE a "Read Only" (in this file the MS-DOS file attribute is set to "Read Only") or system file, this message will appear.

- ⇒ These files are protected so that they cannot be altered. The PSR-SQ16 is unable to perform SAVE or DELETE operations on these files.

* MS-DOS is a registered trademark of Microsoft Corporation.

* When an error message appears in the right-hand digital display, pressing any button returns the PSR-SQ16 to normal mode.

9 SOUND MODULE

This section describes the various settings of the PSR-SQ16's SOUND MODULE. These settings affect the PSR-SQ16's overall sound generation.

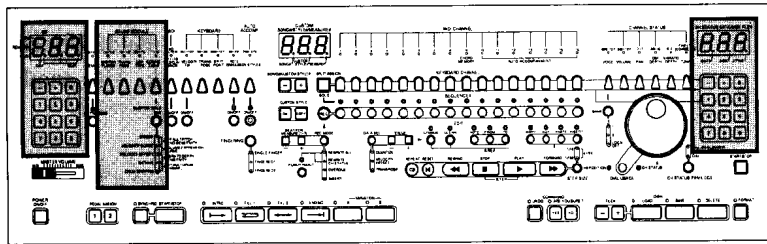

● MASTER TUNING

-16-16
●
MASTER
TUNING



The MASTER TUNING function adjusts the overall pitch of the PSR-SQ16. Use the +/- buttons under the left-hand digital display to set the pitch value between -16 (-50 cents) and 16 (50 cents). Each adjustment increment equals approximately 3 cents (100 cents = 1 semitone).

● TRANSPOSE

-12-12
●
TRANS-
POSE



This function will allow the overall pitch of the PSR-SQ16 to be transposed up or down. Use the +/- buttons under the left-hand digital display to set the TRANSPOSE value between -12 (-1200 cents/-1 octave) and 12 (1200 cents/1 octave). Press the + and - buttons simultaneously to set the value to 00. Each adjustment increment equals one semitone (1 semitone = 100 cents).

NOTE: The TRANSPOSE function has no effect on Drum Kit, Drum Kit w/Gate, and Percussion Voices (Bank 2, Voices 065 through 087).

NOTE: Transpose will affect the key performance only after a change, not during a change.

The difference between Keyboard TRANSPOSE and Sound Module TRANSPOSE.

Keyboard TRANSPOSE only affects data played on the PSR-SQ16 keyboard or a remote keyboard. Sound Module TRANSPOSE affects all functions.

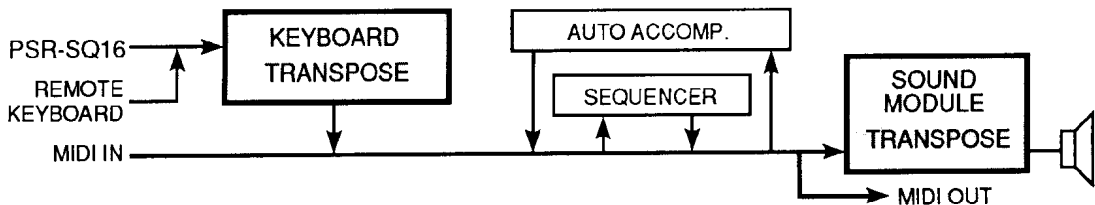

* Use the Keyboard TRANSPOSE function to match the pitch of the keyboard to the pitch of Sequencer performance data, or performance data received through MIDI IN.

NOTE: When the Keyboard and Sound Module TRANSPOSE functions are used simultaneously, the settings of each function will affect data produced by the keyboard. (Example: Setting the Keyboard's TRANSPOSE to 12 and the Sound Module's TRANSPOSE to 12 will produce a two octave transposition of keyboard data).

● DSP TYPE setting

00-15
●
DSP
TYPE



DSP type selects which type of effect will be applied to all channels of the PSR-SQ16. Use the +/- buttons below the left-hand digital display to set a value between 00 and 15. Values 01 through 06 correspond to Reverb settings, values 07 through 15 are digital effects, and 00 is OFF. The numbers cycle like this: 14→15→00→01 or 01→00→15→14.

* Only one DSP effect may be used at a time. Therefore different channels cannot be assigned separate DSP effects. However, the Channel Status DSP DEPTH function can be used to control DSP depth for separate channels (refer to page 33).

00	DRY (OFF)	08	DELAY L, R
01	ROOM	09	STEREO ECHO
02	HALL	10	PAN REFLECTION
03	PLATE	11	EARLY REFLECTION
04	CHURCH	12	GATE REVERB
05	STAGE	13	REVERSE GATE
06	METAL	14	FEEDBACK REVERSE
07	SINGLE DELAY	15	DISTORTION

● CONFIG. TABLE settings (Configuration Table)

What is a Configuration Table?

The various types of MIDI sound modules, keyboards, and other MIDI devices on the market use different voice number settings, note assignments (drum mapping), octave settings, velocity curves, etc. Therefore, performance data and third party software data created on one MIDI system may not be exactly reproduced on other MIDI systems without manually adjusting the parameters.

The PSR-SQ16 incorporates a Configuration Table to improve the match of the Sound Module to other types of software data. The Configuration Table changes the settings of the PSR-SQ16's tone generator, so it affects data played in real time, Auto Accompaniment data, data received through MIDI IN, and Sequencer data from a disk.

- * The PSR-SQ16 has 5 Configuration types, 4 preset and one Custom Configuration that you can design yourself. Any of these Configuration types can be chosen from the panel at any time.
- * A selected preset Table number or Custom Table and its settings, used for Song data in the Sequencer, will be stored in the RAM memory. Selecting a Song automatically recalls that Song's Configuration Table. Therefore, you can store up to 8 different Custom Configuration Tables in the RAM memory, one for each Song.
- * When saving Song data to a disk, the Song's data and Configuration Table data will be saved together. A preset Table number or Custom Table is automatically set to a Song that is loaded.
- * All of the 269 preset Auto Accompaniment Styles use the Default Configuration Table. It is not possible to reproduce the same sound using another Configuration Table.
- * The internal Demo song and Sample Disk Demo songs all use the Default Configuration Table. It is not possible to reproduce the same sound using another Configuration Table.

9. SOUND MODULE

The Configuration Table adjusts the following PSR-SQ16 parameters.

1	Voice Number	Matches MIDI program numbers to the PSR-SQ16's internal voice numbers.
2	Velocity Curve	Selects Velocity Curve for each program number.
3	Velocity Offset	Sets Velocity Offset for each program number.
4	Octave	Sets the Octave shift for each program number.
5	Drum Mapping	Remaps (resets) individual drum voice key assignments.
6	Default Pitch Bend Sensitivity	Sets the default pitch bend sensitivity.
7	Volume/Expression Curve	Sets the volume change curve in relation to the control change volume value and Expression.
8	Vibrato Depth Sensitivity	Sets the vibrato depth sensitivity in relation to the control change Vibrato value.
9	Default Drum Channel	Sets a channel number which becomes Drum channel in the default status.

● Select the Configuration Table

1-5
●
CONFIG.
TABLE



The five different Configuration Tables listed below can be selected on the PSR-SQ16 control panel.

Press the CONFIG. TABLE button and the left-hand digital display will show the currently selected CONFIG. TABLE number. Use the +/- button or numeric buttons located below the left-hand digital display to select a desired table's number.

* Refer to "Configuration Table" in the "List Book" for a more detailed chart.

1	DEFAULT	The initial PSR-SQ16 Configuration Table setting. All panel settings indicated on the front panel (Voice number lists and drum mapping) use this Configuration Table. Preset Auto Accompaniment Styles and Internal Demo Songs use this table.
2	GENERAL MIDI (General MIDI Level 1 System)	This Configuration Table makes MIDI devices more compatible to each other. <i>NOTE: Since PSR-SQ16 is not provided with SE (Sound Effect) voice, program numbers 120 through 127 of General MIDI Level 1 System are not compatible.</i>
3	YAMAHA PORTABLE KEYBOARD	This configuration table corresponds to the standard voice mode of Yamaha portable keyboards such as PSS-790, etc.
4	YAMAHA DOC (Disk Orchestra Collection)	This Configuration Table is used by the Yamaha DOM-30, and other compatible devices which support the Disk Orchestra Collection.
5	CUSTOM	You can create an original Custom Configuration Table. Each Song number can be assigned a different Custom Configuration Table, which is then stored together with that Song's data. Selecting a Song number automatically recalls its Custom Configuration Table. A Custom Configuration Table is saved together with a Song's data to a disk, and recalled together with a Song's data from the disk. Loading data from a disk into a Song number will erase the data and Custom Configuration Table that currently reside there.

NOTE: If the memory of a Song number is reset, the Custom Configuration Table will be reset to Preset Table #1 (Default).

■ How to make a CUSTOM TABLE



1. Press the CONFIG. TABLE button, and its indicator will light.

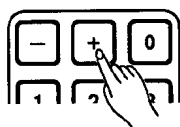

2. Use the +/- buttons or numeric buttons below the left-hand digital display to select a Table between 1 and 5. A preset Table is the foundation upon which a Custom Table is built.

CUSTOM TABLE EDIT



3. Press the CUSTOM TABLE EDIT button.

If you select a preset Table between 1 and 4:

The ARE YOU SURE? indicator flashes, asking you to confirm the deletion of the current Custom Table in order to replace the preset Table. Press the YES button to enable Custom Table Edit.

If you have selected Custom Table 5:

Custom Table Edit is automatically enabled.

CUSTOM TABLE EDIT

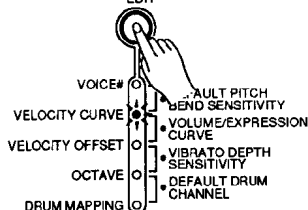

4. Press the CUSTOM TABLE EDIT button to set a parameter.

The VOICE # indicator lights when the Custom Table Edit is ready. At this point, each press of the CUSTOM TABLE EDIT button sequentially changes the parameter. Set each of the desired parameters.

5. To exit the CUSTOM TABLE EDIT mode, press the CONFIG. TABLE button.

■ How to set each parameter

● VOICE

CUSTOM TABLE EDIT

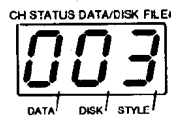
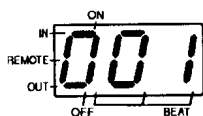
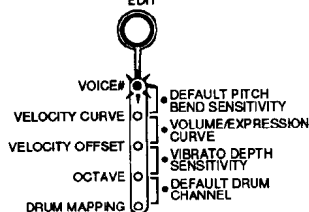

This parameter matches MIDI program numbers to be received to the voice numbers of the PSR-SQ16's Sound Module. Press the CUSTOM TABLE EDIT button until the VOICE # indicator lights. MIDI program numbers to be received will appear in the left-hand digital display, and PSR-SQ16 Voice numbers will appear in the right-hand digital display. First, use the numeric buttons below the left-hand digital display to set the MIDI program number, then use the DIAL or the numeric buttons below the right-hand digital display to set the PSR-SQ16's Voice number. Several MIDI program numbers can be assigned to the same PSR-SQ16 Voice.

NOTE: The program numbers to be received correspond as follows: Program numbers 000 to 127 correspond to Program Changes 0 to 127 of Bank 1, and 128 to 255 correspond to Program Changes 0 to 127 of Bank 2.

9. SOUND MODULE

● VELOCITY CURVE

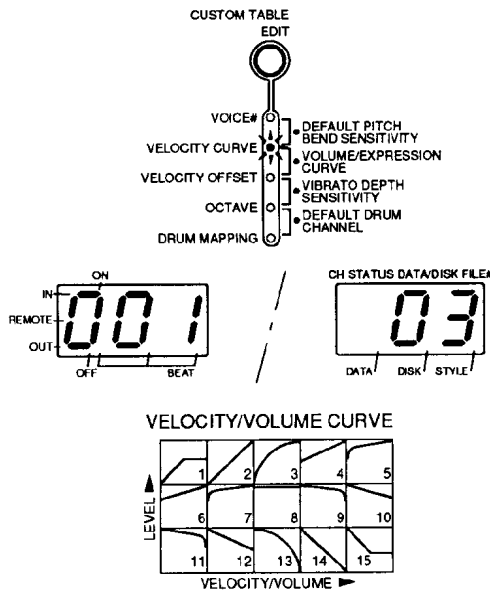

Press the CUSTOM TABLE EDIT button until the VELOCITY CURVE indicator lights. MIDI program numbers to be received will appear in the left-hand digital display and the VELOCITY CURVE currently applied to the Program number will appear in the right-hand digital display. Use the numeric buttons below the left-hand digital display to select Program numbers, then use the numeric buttons below the right-hand digital display to select the desired VELOCITY CURVE. VELOCITY CURVE numbers 1 through 15 are listed below, as well as on the front panel of the PSR-SQ16.

1	48dB Linear + Flat	9	Reverse of 7
2	48dB Curve 2 (Linear)	10	Reverse of 6
3	48dB Curve 3	11	Reverse of 5
4	24dB Curve 1 (Linear)	12	Reverse of 4
5	24dB Curve 2	13	Reverse of 3
6	12dB Curve 1 (Linear)	14	Reverse of 2
7	12dB Curve 2	15	Reverse of 1
8	Flat		

● VELOCITY OFFSET

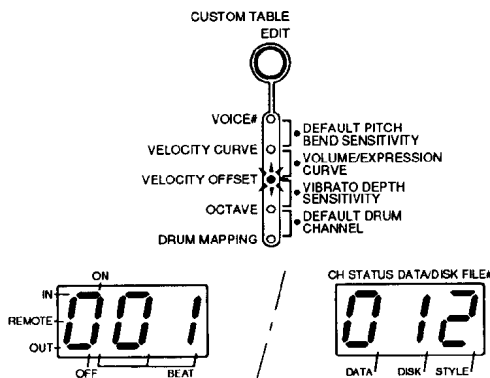

The VELOCITY OFFSET value is the difference between the received velocity value and the velocity actually produced. A VELOCITY OFFSET value can be set for each program number which the PSR-SQ16 receives from external devices.

Press the CUSTOM TABLE EDIT button until the VELOCITY OFFSET indicator lights. MIDI program numbers to be received will appear in the left-hand digital display and the VELOCITY OFFSET currently applied to the Program number will appear in the right-hand digital display. Use the numeric buttons below the left-hand digital display to select Program numbers, then use the numeric buttons below the right-hand digital display to select a VELOCITY OFFSET value between -127 and 127.

* If VELOCITY OFFSET data values total more than 128 or less than 0, the maximum velocity applied will be 127 and the minimum will be 1.

● OCTAVE

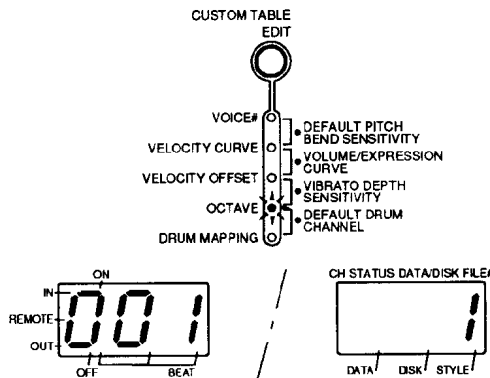

This OCTAVE shift function matches Octave data received from external sources to the PSR-SQ16's Sound Module. Press the CUSTOM TABLE EDIT button until the OCTAVE indicator lights. MIDI program numbers to be received will appear in the left-hand digital display and the OCTAVE currently applied to the Program number will appear in the right-hand digital display. Use the numeric buttons below the left-hand digital display to select Program numbers, then use the numeric buttons below the right-hand digital display to select an OCTAVE value between -3 and 3 (Default setting is 0).

* Bank 2, Voice numbers 065 through 087, cannot be adjusted with the OCTAVE function. If you attempt to do this, "-" will appear in the right-hand digital display.

● DRUM MAPPING

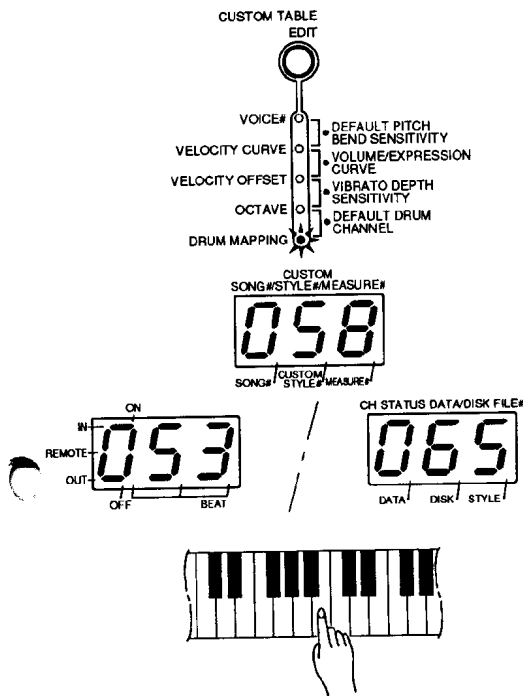

Percussion note numbers from external devices often differ from the percussion key assignments of the PSR-SQ16. This function matches note numbers from external devices to the PSR-SQ16. Press the CUSTOM TABLE EDIT button until the DRUM MAPPING indicator lights. Percussion note numbers to be received will appear in the left-hand digital display and the PSR-SQ16's Percussion (Drum) note numbers will appear in the center digital display. While using the numeric buttons below the left-hand digital display to change the note number to be received, play the desired percussion note on the PSR-SQ16's keyboard, or use the +/- buttons below the center digital display to select an internal Voice that will be produced with the note number (if more than one note is played, the last note played is set into the Drum Map).

During this procedure, the Channel Status Voice Bank 2 indicator is lit and the current Voice number (the Drum Voice that will be mapped) will appear in the right-hand digital display. Use the DIAL, numeric buttons, or +/- button located below the right-hand digital display to select a Drum Voice (065 through 087).

NOTE: Bank 2 Voice numbers 065 through 087 can all be mapped, but only one Voice can be mapped at a time.

NOTE: If the Voice number in the right-hand digital display is changed, all mapping performed up to that point will remain intact.

NOTE: DRUM MAPPING can be set only by using the DEFAULT DRUM CHANNEL (see page 82)

● DEFAULT PITCH BEND SENSITIVITY

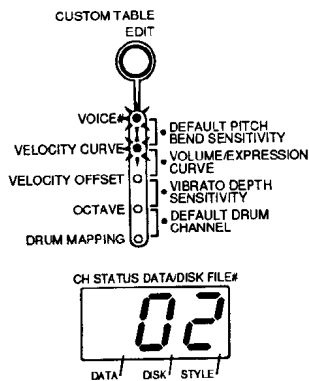

The DEFAULT PITCH BEND SENSITIVITY sets a Pitch Bend Sensitivity value before the tone generator receives Pitch Bend Sensitivity.

Activate the DEFAULT PITCH BEND SENSITIVITY by pressing the CUSTOM TABLE EDIT button until the top two indicators light. The pitch bend sensitivity currently set will appear in the right-hand digital display. Use the numeric buttons or +/- buttons below the right-hand digital display to set the range between 1 and 12. Only one DEFAULT PITCH BEND SENSITIVITY can be set per Configuration Table.

9. SOUND MODULE

● VOLUME/EXPRESSION CURVE

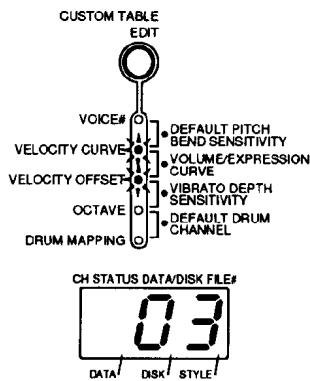

Activate the VOLUME/EXPRESSION CURVE parameter by pressing the CUSTOM TABLE EDIT button until the second and third indicators light. Use the Velocity/Volume Curve list (printed on the PSR-SQ16's front panel) as a reference when adjusting MIDI volume/expression data to the PSR-SQ16's volume level. The currently set VOLUME/EXPRESSION CURVE will appear in the right-hand digital display. Use the numeric buttons or +/- buttons below the right display to select a VOLUME/EXPRESSION CURVE value between 1 and 15. Only one VOLUME/EXPRESSION CURVE value can be set per Configuration Table.

● VIBRATO DEPTH SENSITIVITY

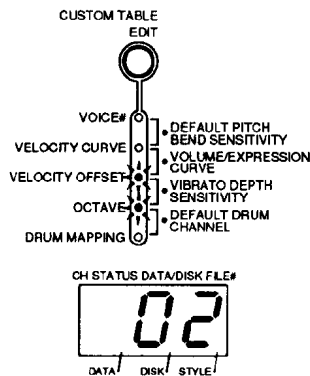

This sets the relationship between the Vibrato depth value and the actual vibrato depth. To activate VIBRATO DEPTH SENSITIVITY, press the CUSTOM TABLE EDIT button until the third or fourth indicator lights. The currently set VIBRATO DEPTH SENSITIVITY value will appear in the right-hand digital display. Use the numeric buttons or +/- buttons to set the value between 0 (off) and 7. Only one VIBRATO DEPTH SENSITIVITY value can be set per Configuration Table.

● DEFAULT DRUM CHANNEL

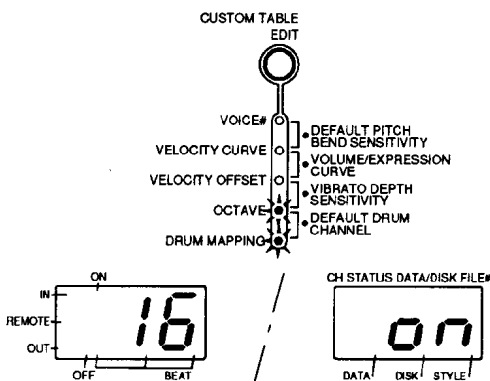

Activate the DEFAULT DRUM CHANNEL by pressing the CUSTOM TABLE EDIT button until the fourth and fifth indicators light. This mode assigns a Drum Voice to a MIDI channel without receiving MIDI program changes. Channel numbers appear in the left-hand digital display and the right-hand digital display indicates whether a selected channel is assigned (ON) or not (OFF) to the Default Drum Channel. Use the numeric buttons located below the left-hand digital display to select a Channel, then use the +/- buttons located below the right-hand digital display and select ON or OFF. In this mode, MIDI program changes received will be ignored, and previously set Drum Maps can be used by the Default Drum Channel.

NOTE: Drum Mapping does not function when Drum Kit or Drum Kit with Gate voices are assigned to channels not dedicated to the Default Drum Channel.

The PSR-SQ16 is a MIDI instrument and can be connected with other MIDI instruments. MIDI, the Musical Instrument Digital Interface, is a universal communication interface that allows MIDI-compatible instruments and equipment to share musical information and control one another. The worldwide MIDI standard regulates the details of everything, from data to hardware, making it possible to exchange performance information between any manufacturer's product, and to create "systems" of MIDI instruments and equipment that offer far greater versatility and control than is possible with isolated instruments.

* For a list of recognized Transmitted and Received MIDI messages, refer to the "MIDI Implementation Chart" in the "List Book".

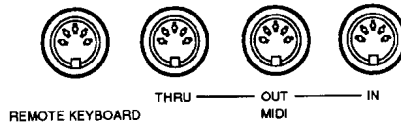

■ MIDI connections

1. REMOTE KEYBOARD terminal and MIDI IN terminal.

The PSR-SQ16 has two MIDI IN terminals: REMOTE KEYBOARD and MIDI IN. Both of these terminals accept MIDI data but differ in operation.

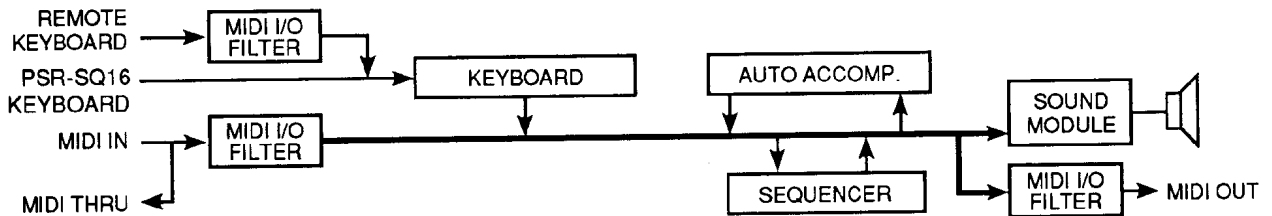

REMOTE KEYBOARD

Use this terminal to connect a remote keyboard that can control the PSR-SQ16. MIDI data received through this terminal has the same effect as data produced on the PSR-SQ16 keyboard, no matter which MIDI channel it is. Therefore, the external keyboard can control all the functions that PSR-SQ16's keyboard can control. Keyboards with 88 keys, or other piano action type keyboards can also be connected to this terminal. In addition, real time START/STOP commands that enter through this terminal can control Auto Accompaniment Start/Stop and Sequencer Play/Stop (when the indicator of a Sequencer's track is lit).

MIDI IN

Data entering through this terminal enters the PSR-SQ16's internal MIDI BUS and is sent to the sequencer and tone generator. You can use this terminal to control the PSR-SQ16 tone generator, or to record an external Sequencer's data into the PSR-SQ16's Sequencer. In addition, real time START/STOP commands that enter through this terminal will control Auto Accompaniment Start/Stop and Sequencer Play/Stop (when the indicator of a Sequencer's track is lit).

2. MIDI OUT

All MIDI BUS data generated on the PSR-SQ16 Keyboard, Note Processor, Sequencer, or Auto Accompaniment, etc. is transmitted to external MIDI devices via the MIDI OUT terminal.

About Echo Back

- MIDI data received via the MIDI IN terminal is not transmitted via the MIDI OUT terminal.
- MIDI data received by the REMOTE KEYBOARD terminal is transmitted in the same way as MIDI data produced by the PSR-SQ16, via the MIDI OUT terminal.

3. MIDI THRU

MIDI data received via the MIDI IN terminal is directly transmitted via the MIDI THRU terminal with no alteration.

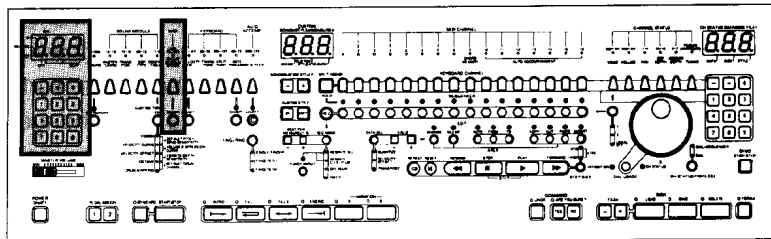

● I/O FILTER (Input/Output Filter)

The I/O FILTER determines if data received through the MIDI IN or REMOTE KEYBOARD jacks will be accepted or ignored. It also determines if and how Channel messages and data from Channels 1 through 16, will be transmitted (via the MIDI OUT jack). Further, it determines if the tone generator's BANK # (refer to page 33) will be transmitted via MIDI OUT, and if Clock or Commands (start, stop, continue, song position, song select) will be accepted or ignored.

I/O
FILTER
●
CH1-16/
B1/2/CLV
CMNDS



ON/OFF



● MIDI IN of Channel 12 is switched OFF.

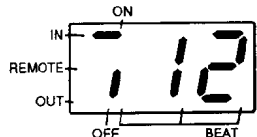

● BANK 1 is ON

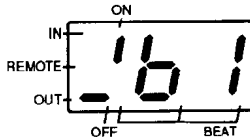

● REMOTE CLOCK is switched OFF.

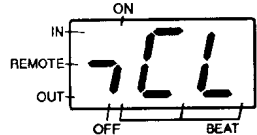

● BANK 2 is OFF

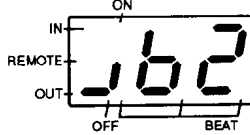

● MIDI OUT COMMAND is ON.

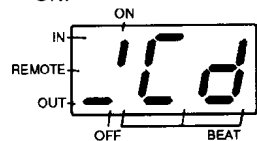

1. Press the I/O FILTER button, and its indicator will light. Then, the IN/REMOTE/OUT, CLOCK, and COMMAND functions of Keyboard Channels 1 through 16 can be changed, by using the +/- buttons below the left-hand digital display. Functions appear in this order: IN 1 through 16, IN CLOCK (indicated in the display as CL), IN COMMAND (indicated in the display as Cd), REMOTE 1 through 16, REMOTE CLOCK, REMOTE COMMAND, OUT 1 through 16, BANK 1 and BANK 2 (indicated in the display as b1 and b2), OUTCLOCK, and OUT COMMAND.

2. Use the ON/OFF button below the I/O FILTER button to select whether a function will be activated or deactivated. Press ON to activate a function and press OFF to deactivate a function. Channels 1 through 16, Clock, Command, and Bank (only for OUT) can be changed for each IN/REMOTE/OUT.

* MIDI IN filter settings do not affect data transmitted via the MIDI THRU jack.

* Defaults are all ON.

* Clock signals can be received via either the MIDI IN jack or the REMOTE KEYBOARD jack. When both filters are switched ON, clock data received via the MIDI IN jack is used. When there is no signal received via the MIDI IN jack, the signal received via the REMOTE KEYBOARD jack is used. When there is no signal received from either jack, the internal clock is used.

* When using an external clock, "EC" appears in the left-hand digital display, and tempo settings from the PSR-SQ16 have no effect.

* When Auto Accompaniment is ON, note data received by Channel 9 through MIDI IN is used as chord performance data, and the tone generator does not produce sound.

HINT

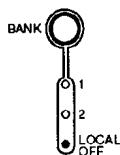

Recording BANK changes.

When both BANK 1 and Bank 2 are set to OFF (with the procedure explained above), set the BANK button to LOCAL OFF to transmit Channel data via the MIDI OUT. BANK changes can be recorded into the Sequencer as control changes. Therefore, it is possible to create a Song using a combination of internal and external tone generators, by switching between the internal and an external tone generator for each channel.

Troubleshooting

Symptom	Cause	Solution
Turning the power switch on produces a popping noise.	Current flows into your unit.	Nothing is wrong with your unit.
No sound from the speakers.	The volume is turned down.	Turn up the volume.
	The headphone plug is inserted to the headphone terminal.	Unplug the headphone.
	Voice Bank Select is set to LOCAL OFF.	Select Voice BANK 1 or BANK 2.
	A VOICE number does not have a Voice. This number configuration is not assigned a Voice. (for example, BANK 1 Default configurations 104 through 127).	Select a VOICE number that has a Voice.
A Voice number displays as "---", and the Voice number cannot be changed.	The Keyboard Channel is assigned to the Default Drum Channel.	Reassign the configuration.
A new chord is played when playing Auto Accompaniment, but the new chord is not generated.	Play of a new chord has begun before the keys of the previous chord have been completely released.	Completely release the keys of one chord before beginning play of another.
	You play Fingered chords in the Single Finger mode, or vice versa.	The Single Finger mode and the Fingered mode are each designed to play different chords. Check that you are playing the proper chord in the proper mode.
The voice of Auto Accompaniment or the demo songs are not appropriate.	The default configuration table is not used.	Set the configuration table to No.1 (Default).

Optional Accessories

- Headphones HPE-5/HPE-3
- Foot switch FC5/FC4
- Foot controller FC7
- Keyboard stand L-5

PSR-SQ16 specifications

Keyboard:

61 touch responsive keys (C1-C6)

Voice:

200 voices

Polyphony (Maximum number of simultaneous sound generation):

56 (28 x 2) sounds

Accompaniment:

269 Styles + 8 Custom styles

Demonstration:

Internal: 1 song

Disk: 9 songs (1 is the same as the internal song.)

Other controls:

Power switch ON/OFF, Master volume, Tempo, Metronome

SOUND MODULE

Master tuning, Transpose, DSP type, Configuration table (Custom Table

Edit: Voice Number, Velocity Curve, Velocity Offset, Octave, Drum Mapping,

Default Pitch Bend Sensitivity, Volume/Expression Curve, Vibrato Depth

Sensitivity, Default Drum Channel)

MIDI

Input/Output filter (Channel 1 through 16/Bank 1,2/Clock/Command ON/OFF)

KEYBOARD

Velocity Fix ON/OFF, Transpose, Split point, Note processor ON/OFF

AUTO ACCOMP.

Style number, ON/OFF, Fingering (Single Finger, Fingered 1, Fingered 2),

Synchro, Start/Stop, Intro, Fill 1, Fill 2, Ending, Variation A/B

KEYBOARD CHANNEL

1~16, Split assign/Solo

SEQUENCER

1~16, Recording, Recording mode (Rewrite all (Overwrite), Rewrite channel

status, Overdubbing, Insert, Punch IN/OUT), Beat per measure (+/-), Song

number/Custom Style number (+/-), Custom Style (On/Copy)

EDIT: Data select (Quantize, Velocity Offset, Transpose), Value +/-, Change,

Clear, Note, From, To, Copy, Cut, Paste, Insert, Repeat, Reset, Rewind,

Stop, Play, Forward, Step Size (1/16, 1/24, 1/192)

CHANNEL STATUS

Voice (BANK 1, 2, LOCAL OFF) Volume, Pan, DSP Depth, Vibrato Depth,

Tuning (fine/coarse)

DIAL USAGE

Channel Status/position, Channel Status Privilege, (Dial + Sequencer, Dial)

Demo

Start/Stop

Pedal Assign

1, 2

COMMAND

Undo, ARE YOU SURE? (YES/NO)

DISK

File number (-/+), Load, Save, Delete, Format

Numeric buttons (in two places)

-/+, 0~9

External connectors:

Headphones, AUX. OUT (R, L+R/L), AUX. IN (R, L), Pedal (1,2), MIDI (IN,

OUT, THRU, REMOTE KEYBOARD)

Amplifier Output: 8.3W x 2

Speaker: (12cm + 5 cm) x 2

Dimension (Width x Depth x Length): 953 mm x 428 mm x 165 mm

Weight: 11.5 kg

Accessories:

- Demo disk
- Music stand
- Owner's Manual
- AC cord

* Specifications subject to change without notice.

INDEX

A

AC INLET jack	8
ARE YOU SURE?	26, 44, 55, 62, 69
AUTO ACCOMPANIMENT	16, 39
AUTO ACCOMPANIMENT CHORD DATA	50
AUTO ACCOMPANIMENT PERFORMANCE DATA	50
AUX. IN (R, L) jack	8
AUX. OUT (R, L+R/L) jack	8

B

BANK	10, 33
BANK CHANGES	84
BEAT DISPLAY	22
BEAT PER MEASURE	4

C

CENTER DIGITAL DISPLAY ...	26, 44, 61
CHANGE	55~57
CHANNEL STATUS	31
CHANNEL STATUS PRIVILEGE	35
CLEAR	58
CLOCK (MIDI)	84
CLOCK (STEP MODE)	51
COARSE (TUNING)	34
COMMAND	26, 44, 55, 69
CONFIGURATION TABLE	77
COPY	58
CUSTOM STYLE	61
CUSTOM STYLE NUMBER	61
CUSTOM TABLE EDIT (CONFIGURATION TABLE)	79
CUT	59

D

DATA SELECT	55~57
DEFAULT PITCH BEND SENSITIVITY	81
DEFAULT DRUM CHANNEL	82
DELETE	73
DEMO DISK	25
DEMO SONG	24
DIAL	11, 32, 46
DIAL USAGE	11, 32, 46
DISK DRIVE	25, 69
DISK FORMAT	69
"DISK IN USE" INDICATOR	26, 69
DRUM MAPPING	81
DSP DEPTH	33
DSP TYPE	77

E

EDIT	53
EDIT BUFFER	58, 59
EJECT button	27, 69
ENDING	16, 23
ERROR MESSAGE	60, 74
ESEQ	68
EXPRESSION CURVE	82

F

FILE FORMAT	67
FILE NUMBER	25, 70, 71, 73
FILL 1	16, 23
FILL 2	16, 23
FINE (TUNING)	34
FINGERED 1 MODE	20
FINGERED 2 MODE	21
FINGERING	19, 40
FOOT CONTROLLER	64
FOOT SWITCH	64
FORMAT (INITIALIZING)	69
FORWARD	46, 51
FROM	54
FULL ACCOMPANIMENT	16

G

GENERAL MIDI	78
GROUP FADER	49

H

HARMONY	37
HEADPHONES jack	8

I

INPUT/OUTPUT FILTER	84
INSERT (EDIT)	59, 60
INSERT (RECORDING MODE)	48
INTRO	16, 22

K

KEYBOARD	36
KEYBOARD CHANNEL	12, 30
KEYBOARD SPLIT	15

L

LEFT-HAND DIGITAL DISPLAY	18, 36, 84
LOAD	26, 72
LOCAL OFF	33

M

MASTER TUNING	76
MASTER VOLUME	10
METRONOME	65
MIDI	83
MIDI CHANNEL	83
MIDI INPUT/OUTPUT FILTER	84
MIDI terminal	83
MULTI TRACK RECORDING	47
MUSIC STAND	9

N

NO button	26, 44, 55, 62, 69
NOTE	54
NOTE EFFECT	37
NOTE PROCESSOR	37
NUMERIC BUTTONS (LEFT) -,+,0-9	18, 36~38, 79
NUMERIC BUTTONS (RIGHT) -,+,0-9	11, 31, 33~34

O

OCTAVE	80
OVERDUB	48

P

PAN	33
PART ACCOMPANIMENT	16
PASTE	59, 60
PEDAL ASSIGN	64
PERCUSSION VOICE	11
PITCH BEND RANGE	38
PITCH BEND SENSITIVITY	35
PITCH BEND WHEEL	14, 35, 38
PLAY button	27, 45, 46
PLAYBACK	27, 46
POSITION	46
POWER SWITCH	10
PRESELECTING SECTION	41
PRESET STYLE	16
PUNCH IN/OUT	49, 52

Q

QUANTIZE	55
----------------	----

R

RECORDING	44
RECORDING MODE	48
REMOTE KEYBOARD	83
REPEAT	50, 63
RESET	46
REWIND	46, 51

REWRITE ALL	48
REWRITE CHANNEL STATUS	48
RHYTHM STYLE	16
RIGHT-HAND DIGITAL DISPLAY	11, 25, 31, 70, 71

S

SAVE	70
SECTION	16, 40
SEQUENCER	42
SINGLE FINGER MODE	20, 40
SOLO FUNCTION	27, 46
SONG FILE	70, 71
SONG NUMBER	27, 44
SOUND MODULE	76
SPLIT ASSIGN button	15, 30
SPLIT POINT	37
STANDARD MIDI FILE	67
START/STOP	22
STEP MODE	51
STEP SIZE button	51
STYLE# button	18, 39
SYNCHRO	22
SYSTEM CHART	28

T

TEMPO	18, 65
TO	54
TRACK	42, 45
TRANSPOSE (EDIT)	57
TRANSPOSE (KEYBOARD)	36
TRANSPOSE (SOUND MODULE) ...	76
TUNING	34

U

UNDO	55
------------	----

V

VALUE	55~57
VARIATION A/B	16, 22
VELOCITY CURVE	80
VELOCITY FIX	36
VELOCITY OFFSET (CUSTOM TABLE EDIT)	80
VIBRATO DEPTH	33
VIBRATO DEPTH SENSITIVITY	82
VOICE	10, 33
VOICE# (CUSTOM TABLE EDIT)	79
VOLUME	33
VOLUME CURVE	82

Y

YES button	26, 44, 55, 62, 69
------------------	--------------------

IMPORTANT SAFETY INSTRUCTIONS

INFORMATION RELATING TO PERSONAL INJURY, ELECTRICAL SHOCK, AND FIRE HAZARD POSSIBILITIES HAS BEEN INCLUDED IN THIS LIST.

WARNING- When using any electrical or electronic product, basic precautions should always be followed. These precautions include, but are not limited to, the following:

- 1.** Read all Safety Instructions, Installation Instructions, Special Message Section items, and any Assembly Instructions found in this manual **BEFORE** making any connections, including connection to the main supply.
- 2.** **Main Power Supply Verification:** Yamaha products are manufactured specifically for the supply voltage in the area where they are to be sold. If you should move, or if any doubt exists about the supply voltage in your area, please contact your dealer for supply voltage verification and (if applicable) instructions. The required supply voltage is printed on the name plate. For name plate location, please refer to the graphic found in the Special Message Section of this manual.
- 3.** This product may be equipped with a polarized plug (one blade wider than the other). If you are unable to insert the plug into the outlet, turn the plug over and try again. If the problem persists, contact an electrician to have the obsolete outlet replaced. Do **NOT** defeat the safety purpose of the plug.
- 4.** Some electronic products utilize external power supplies or adapters. Do **NOT** connect this type of product to any power supply or adapter other than one described in the owners manual, on the name plate, or specifically recommended by Yamaha.
- 5.** **WARNING:** Do not place this product or any other objects on the power cord or place it in a position where anyone could walk on, trip over, or roll anything over power or connecting cords of any kind. The use of an extension cord is not recommended! If you must use an extension cord, the minimum wire size for a 25' cord (or less) is 18 AWG. **NOTE:** The smaller the AWG number, the larger the current handling capacity. For longer extension cords, consult a local electrician.
- 6.** **Ventilation:** Electronic products, unless specifically designed for enclosed installations, should be placed in locations that do not interfere with proper ventilation. If instructions for enclosed installations are not provided, it must be assumed that unobstructed ventilation is required.
- 7.** **Temperature considerations:** Electronic products should be installed in locations that do not significantly contribute to their operating temperature. Placement of this product close to heat sources such as; radiators, heat registers and other devices that produce heat should be avoided.
- 8.** This product was **NOT** designed for use in wet/damp locations and should not be used near water or exposed to rain. Examples of wet/damp locations are; near a swimming pool, spa, tub, sink, or wet basement.
- 9.** This product should be used only with the components supplied or; a cart, rack, or stand that is recommended by the manufacturer. If a cart, rack, or stand is used, please observe all safety markings and instructions that accompany the accessory product.
- 10.** The power supply cord (plug) should be disconnected from the outlet when electronic products are to be left unused for extended periods of time. Cords should also be disconnected when there is a high probability of lightning and/or electrical storm activity.
- 11.** Care should be taken that objects do not fall and liquids are not spilled into the enclosure through any openings that may exist.
- 12.** Electrical/electronic products should be serviced by a qualified service person when:
 - a. The power supply cord has been damaged; or
 - b. Objects have fallen, been inserted, or liquids have been spilled into the enclosure through openings; or
 - c. The product has been exposed to rain; or
 - d. The product does not operate, exhibits a marked change in performance; or
 - e. The product has been dropped, or the enclosure of the product has been damaged.
- 13.** Do not attempt to service this product beyond that described in the user-maintenance instructions. All other servicing should be referred to qualified service personnel.
- 14.** This product, either alone or in combination with an amplifier and headphones or speaker/s, may be capable of producing sound levels that could cause permanent hearing loss. **DO NOT** operate for a long period of time at a high volume level or at a level that is uncomfortable. If you experience any hearing loss or ringing in the ears, you should consult an audiologist.
IMPORTANT: The louder the sound, the shorter the time period before damage occurs.
- 15.** Some Yamaha products may have benches and/or accessory mounting fixtures that are either supplied as a part of the product or as optional accessories. Some of these items are designed to be dealer assembled or installed. Please make sure that benches are stable and any optional fixtures (where applicable) are well secured **BEFORE** using. Benches supplied by Yamaha are designed for seating only. No other uses are recommended.

PLEASE KEEP THIS MANUAL

FCC INFORMATION (U.S.A.)

1. IMPORTANT NOTICE: DO NOT MODIFY THIS UNIT!

This product, when installed as indicated in the instructions contained in this manual, meets FCC requirements. Modifications not expressly approved by Yamaha may void your authority, granted by the FCC, to use the product.

2. IMPORTANT: When connecting this product to accessories and/or another product use only high quality shielded cables. Cable/s supplied with this product **MUST** be used. Follow all installation instructions. Failure to follow instructions could void your FCC authorization to use this product in the USA.

3. NOTE: This product has been tested and found to comply with the requirements listed in FCC Regulations, Part 15 for Class "B" digital devices. Compliance with these requirements provides a reasonable level of assurance that your use of this product in a residential environment will not result in harmful interference with other electronic devices. This equipment generates/uses radio frequencies and, if not installed and used according to the instructions found in the users manual, may cause interference harmful to the operation of other electronic devices. Compliance with FCC regulations does not guarantee that interference will not occur in all installations. If this product is found to be the source of interference, which can be determined by turning the unit "OFF" and "ON", please try to eliminate the problem by using one of the following measures:

Relocate either this product or the device that is being affected by the interference.

Utilize power outlets that are on different branch (circuit breaker or fuse) circuits or install AC line filter/s.

In the case of radio or TV interference, relocate/reorient the antenna. If the antenna lead-in is 300 ohm ribbon lead, change the lead-in to co-axial type cable.

If these corrective measures do not produce satisfactory results, please contact the local retailer authorized to distribute this type of product. If you can not locate the appropriate retailer, please contact Yamaha Corporation of America, Electronic Service Division, 6600 Orangethorpe Ave, Buena Park, CA90620

The above statements apply **ONLY** to those products distributed by Yamaha Corporation of America or its subsidiaries.

IMPORTANT NOTICE FOR THE UNITED KINGDOM

Connecting the Plug and Cord

IMPORTANT. The wires in this mains lead are coloured in accordance with the following code:

BLUE : NEUTRAL
BROWN : LIVE

As the colours of the wires in the mains lead of this apparatus may not correspond with the coloured markings identifying the terminals in your plug proceed as follows:

The wire which is coloured **BLUE** must be connected to the terminal which is marked with the letter **N** or coloured **BLACK**.

The wire which is coloured **BROWN** must be connected to the terminal which is marked with the letter **L** or coloured **RED**.

Making sure that neither core is connected to the earth terminal of the three pin plug.

* This applies only to products distributed by Yamaha-Kemble Music (U.K.) Ltd.

* This applies only to products distributed by YAMAHA CORPORATION OF AMERICA.

Dette apparat overholder det gældende EF-direktiv vedrørende radiostøj.

Cet appareil est conforme aux prescriptions de la directive communautaire 87/308/CEE.

Diese Geräte entsprechen der EG-Richtlinie 82/499/EWG und/oder 87/308/EWG.

This product complies with the radio frequency interference requirements of the Council Directive 82/499/EEC and/or 87/308/EEC.

Questo apparecchio è conforme al D.M. 13 aprile 1989 (Direttiva CEE/87/308) sulla soppressione dei radiodisturbi.

Este producto está de acuerdo con los requisitos sobre interferencias de radio frecuencia fijados por el Consejo Directivo 87/308/CEE.

YAMAHA CORPORATION

For details of products, please contact your nearest Yamaha or the authorized distributor listed below.

Pour plus de détails sur les produits, veuillez-vous adresser à Yamaha ou au distributeur le plus proche de vous figurant dans la liste suivante.

Die Einzelheiten zu Produkten sind bei ihrer unten aufgeführten Niederlassung und bei Yamaha Vertragshändlern in den jeweiligen Bestimmungsländern erhältlich.

Para detalles sobre productos, contacte su tienda Yamaha más cercana o el distribuidor autorizado que se lista debajo.

NORTH AMERICA

CANADA

Yamaha Canada Music Ltd.
135 Milngrove Avenue, Scarborough, Ontario,
M1S 3K1, Canada
Tel: 416 298 4311

U.S.A.

Yamaha Corporation of America
6900 Orange Grove Ave., Buena Park, Calif. 90620,
U.S.A.
Tel: 714 522 0001

MIDDLE & SOUTH AMERICA

MEXICO

Yamaha De Mexico S.A. De C.V.,
Departamento de ventas
Javier Ruiz Gomez No.1149, Col. Gpe. De
Moral, Deleg. Iztapalapa, 09309 Mexico, D.F.
Tel: 686 0933

BRASIL

Yamaha Musical Do Brasil LTDA
Av. Rondonias 2636, São Paulo, Brasil
Tel: 65 71 851 1377

PANAMA

Yamaha De Panama S.A.
Edificio Intersacsa, Calle Clara Mendocino 10, P.O.
Box 101, C.A. 095, Ciudad de Panama, Panama
Tel: 507 69 8311

OTHER LATIN AMERICAN COUNTRIES AND CARIBBEAN COUNTRIES

Yamaha Music Latin America Corp.
6901 Blue Lagoon Drive, Miami, Florida 33147,
U.S.A.
Tel: 305 261 4275

EUROPE

THE UNITED KINGDOM IRELAND

Yamaha-Kemble Music(U.K.) Ltd
Surrey House, 100, Edinboro, Milton Keynes
MK11 3PH, England
Tel: 0495 390700

GERMANY SWITZERLAND

Yamaha Europa GmbH.
Luisenpark 10, D-10623 Berlin, Germany
Tel: 30 62 11 11

AUSTRIA HUNGARY

Yamaha Music Austria GmbH
Spatzengasse, D-1100 Wien, Austria
Tel: 0222 6609940

THE NETHERLANDS

Yamaha Music Benelux B.V.,
Verkoop Administratie
Koningin Wilhelmina 1, 1017 CA Amsterdam,
The Netherlands
Tel: 020 535 5400

BELGIUM LUXEMBOURG

Yamaha Music Benelux B.V.,
Brussels-office
Koningin Wilhelmina 1, 1017 CA Amsterdam,
The Netherlands
Tel: 02 52 75 777

FRANCE

Yamaha Musique France, Division Export
BP 701, 71111 Marolles-sur-Loire, France
Tel: 03 64 11 3066

ITALY

Yamaha Musica Italia S.P.A.,
Home Keyboard Division
Via Feltrina 88, 20120 Fontana/Milano, Italy
Tel: 02 437 4081

SPAIN

Yamaha-Hazen Electronica Musical, S.A.
Jorge Juan 30, 28001, Madrid, Spain
Tel: 91 477 7270

PORTUGAL

Valentim de Carvalho C/SA
Estrada de Pedro Salvo, Parque de Arcos 2780 Oeiras,
Portugal
Tel: 01 447 3398, 01 447 3399

GREECE

Philippe Nakas S.A.
Navarino Street 15, P.O. Code 10680, Athens, Greece
Tel: 01 364 7771

SWEDEN

Yamaha Scandinavia AB
P.O. Box 100, Westergatan 1, Box 8777, SE-101 87,
Stockholm, Sweden
Tel: 08 496000

DENMARK

Yamaha Scandinavia Ejend. Danmark
Larsensvej 80, DK-2600 Tønderborg, Denmark
Tel: 45 77 31 55

FINLAND

Fazer Music Inc.
Keskuskatu 10, SF-00100 Helsinki, Finland
Tel: 09 47111

NORWAY

Narud Yamaha AS
Osterodden 29, NO-145 Østera,
Norway
Tel: 02 21 21

ICELAND

Páll H. Pálsson
P.O. Box 8, Reykjavik, Iceland
Tel: 01 7440

EAST EUROPEAN COUNTRIES (Except HUNGARY)

Yamaha Europa GmbH
Semmeringstr. 21/24, D-2084 Kellingm., F.R.G.
Tel: 0410 31 111

AFRICA

Yamaha Corporation,
International Marketing Division
Nakazawa-cho 10-1, Hamamatsu, Japan 430
Tel: 053 460 2311

MIDDLE EAST ASIA

ISRAEL

R.V.A. International Co. Ltd.
P.O. Box 100, Tel-Aviv, Israel
Tel: 03 69425

TURKEY CYPRUS

Yamaha Musiques France, Division Export
BP 701, 71111 Marolles-sur-Loire, France
Tel: 03 64 11 3066

OTHER COUNTRIES

Yamaha Corporation,
International Marketing Division
Nakazawa-cho 10-1, Hamamatsu, Japan 430
Tel: 053 460 2311

ASIA

HONG KONG

Tom Lee Music Co., Ltd.
15/F., World Shipping Centre, Harbour City,
7 Canton Road, Kowloon, Hong Kong
Tel: 3 722 1098

INDONESIA

PT. Yamaha Music Indonesia (Distributor)
PT. Nusantara
Gedung Yamaha Music Centre, Jalan Jend. Sudarto
Subroto Kav. 4, Jakarta 12930, Indonesia
Tel: 011 820 2577

MALAYSIA

Yamaha Music Malaysia Sdn., Bhd.
19/28, Jalan SS 2/2, Kelang, Kuala Selangor,
Malaysia
Tel: 3 71 7 8977

PHILIPPINES

Yupango Music Corporation
339 G/F, Payat Avenue, Makati, Metro Manila
1201, Philippines
Tel: 7 55 37

SINGAPORE

Yamaha Music Asia Pte., Ltd
50 Tanjong Pagar Square, Singapore
Tel: 7 47 4074

TAIWAN

Kung Hsue Sby. Trading Co., Ltd.
R.H. Taichung, Chungking 242, No. 1, Taichung,
2/F, Taichung, Chungking, Taiwan, R.O.C.
Tel: 2 709 129

THAILAND

Sam Music Yamaha Co., Ltd.
933/17, Rama I Road, Pathumwan, Bangkok,
Thailand
Tel: 7 27 698

THE PEOPLE'S REPUBLIC OF CHINA AND OTHER ASIAN COUNTRIES

Yamaha Corporation,
International Marketing Division
Nakazawa-cho 10-1, Hamamatsu, Japan 430
Tel: 053 460 2311

OCEANIA

AUSTRALIA

Yamaha Music Australia Pty. Ltd.
1/33 Market Street, Sydney, New South Wales,
Australia
Tel: 02 924 9185

NEW ZEALAND

Music Houses of N.Z. Ltd.
140/148 Captain Cook Road, Te Paparua,
Auckland, New Zealand
Tel: 09 50 00 90

COUNTRIES AND TRUST TERRITORIES IN PACIFIC OCEAN

Yamaha Corporation,
International Marketing Division
Nakazawa-cho 10-1, Hamamatsu, Japan 430
Tel: 053 460 2311

HEAD OFFICE Yamaha Corporation, Electronic Musical Instrument Division
Nakazawa-cho 10-1, Hamamatsu, Japan 430
Tel: 053 460 3273

© 1986 YAMAHA CORPORATION

YAMAHA

YAMAHA CORPORATION
PO Box 1, Hamamatsu, Japan

YAMAHA CORPORATION, 1986, 100% Japanese owned