

SELF-POWERED MIXER

OWNER'S MANUAL

EM-120

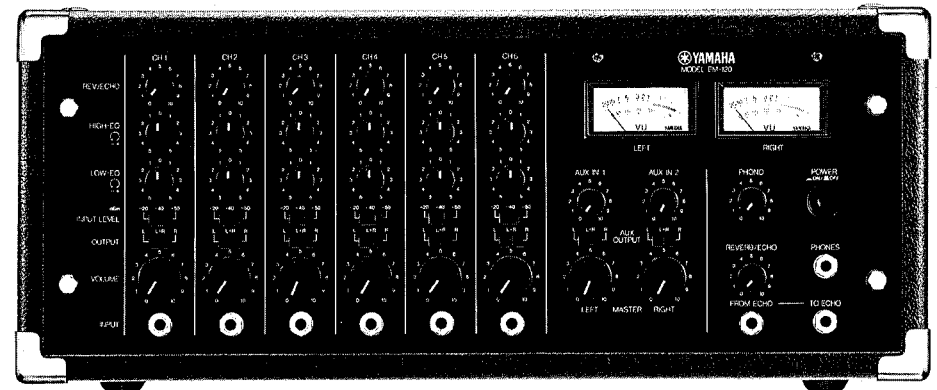

Contents	
Features	2
Precautions & Connections	3
Front Panel	4
Rear Panel	5
EM-120 Specifications	7
Block Diagram	8

Congratulations!

You have just joined the large and growing family of satisfied users of Yamaha products. You have chosen wisely when you picked model EM-120 as your mixer.

Years of dependable service await you.

You may already have a good general understanding of mixers. We recommend careful reading of this OWNER'S MANUAL before connecting your mixer to take the best advantage of your mixer's capabilities. You will learn how to connect the mixer properly and how to really get the most out of all the features Yamaha has incorporated into this mixer.

If you need any special help or service, see your Yamaha dealer. He knows what to do and will be happy to help you.

You've made a good choice. We are confident you'll be satisfied with the performance and versatility of EM-120.

FEATURES

The EM-120 is a six input, stereo output mixer with a built-in 100 Watt power amplifier that has the quality, performance, versatility and roadability needed for today's musical situations. Check the features here and study the explanations of the panels. You'll see immediately that the EM-120 has everything but the creativity of the musician or soundman.

Superior Electrical Performance

This mixer makes full use of Yamaha's advanced electronics technology and nine decades of experience as a manufacturer of musical instruments. It is compact and functional in design, with many full performance features that make it ideal for recording, sub-mixing or for use as part of a PA system or instrument mixer system.

Total of 10 Inputs

6 INPUT channels, 1 PHONO stereo input (L & R) and 3 auxiliary monaural inputs. All 6 INPUT channels have their own individual VOLUME, LOW/HIGH-EQ and REVERB/ECHO controls, and INPUT LEVEL and OUTPUT selector switches. All inputs (except PHONO) are standard phone jacks.

Built-in Reverb Unit

Without the addition of a separate unit, this built-in Accutronics spring-type reverberation unit gives you the freedom for some very special effects for each channel. But there are also provisions for connection of external echo delay or other devices.

Big Power Output

The EM-120 is a self-powered mixer that can deliver 100 Watts (2x50W) into any 8-ohm speaker system that is designed to handle this amount of input. Plenty of power for clubs and small stages.

Easy-to-read VU meters

The two precision VU meters provide a visual indication of average power output level and give you greater control over the sound you want to create. Both meters are illuminated for easier reading.

Better Monitoring

The headphones jack accepts almost any stereo headphones and assures accurate monitoring even in the loudest environment. The sound you hear is the same as that which feeds the speaker output but at a lower level.

Rugged, Roadable Package

The EM-120 is rugged but lightweight. It's built to take normal rough handling met during work on the road. The black leatherette finish and reinforced corners resist scratches and enhance the appearance.



PRECAUTIONS & CONNECTIONS

Precautions

The EM-120 is rugged and durable, but not indestructible. It has been designed to stand up to tough handling but certain precautions must be taken. The most frequent cause of trouble is improper use due to incomplete understanding of exactly what the mixer can and cannot do. You can easily avoid these mistakes by following the precautions listed here before plugging in or attempting to operate your mixer.

Be sure the POWER switch is off before plugging in the power cord.

Unplug the POWER cord, or at least make sure the POWER switch is off before connecting or disconnecting any cords.

If a fuse blows, be sure that the replacement is exactly the same type and rating. If you have regular fuse failures, consult your Yamaha dealer.

Do not expose the mixer to direct sunlight and other sources of excessive heat, humidity, dust or shock.

Connecting Up

1. Before plugging in the power cord, make sure the VOLTAGE SELECTOR on the rear panel is properly set for your locality. (U.S., Canadian and Australian models are preset and thus don't have this feature.) For the British Standard model, please refer to the instructions on page 6.

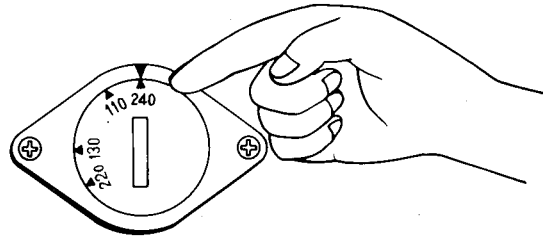

2. Set the front panel VOLUME controls to "zero" and make sure the POWER switch is OFF.

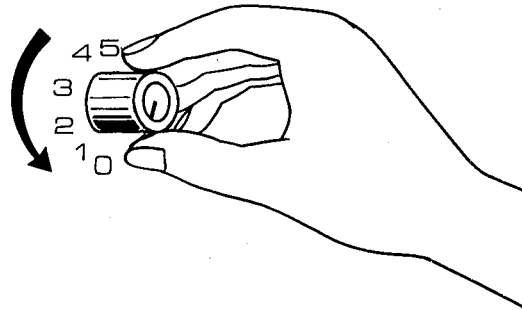

3. Connect your speaker, etc. to the output jacks.

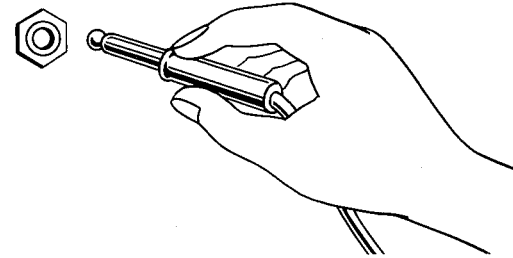

4. Connect the input cords from your instruments and/or mics to the INPUT, AUX IN, and FROM ECHO jacks.

5. Plug in the power cord.

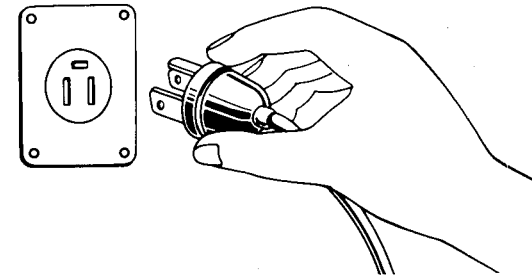

6. Push on the POWER switch.

7. Adjust the VOLUME and other controls. Now you are ready to mix sound sources as you like.

FRONT PANEL

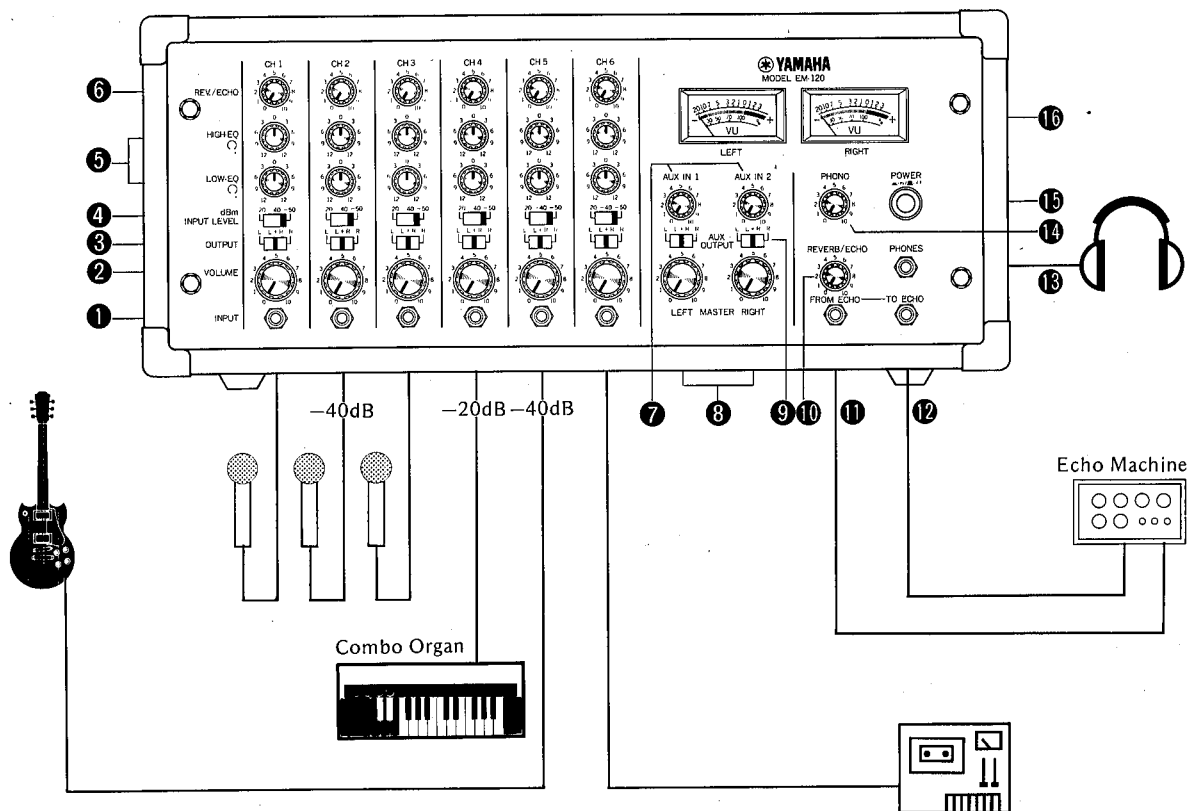

FRONT PANEL

1 CHANNEL INPUT JACKS

These unbalanced phone jacks, inputs to channels 1 through 6, accept audio from any source of -50dB (2.5mV) (mic level) to -20dB (78mV) nominal level (low line level), depending on the setting of the INPUT level switch. Higher levels than those indicated on the INPUT level switch, could be accommodated by turning down the channel VOLUME, but this would result in a loss of headroom.

2 CHANNEL VOLUME

The rotary control provides continuously variable adjustment of the channel's output to the program and the reverb/echo mixing buses.

3 OUTPUT SELECTOR SWITCHES

Each selector can be used to feed the channel input to the left or right channel, or both, for the following outputs; SPEAKER, REC. OUT, PHONES.

4 INPUT LEVEL SELECTOR SWITCHES

These switches change the input attenuation to accommodate nominal levels of -50 , -40 or -20dB ($0\text{dB} = 0.775\text{V}$). These markings indicate the nominal sensitivity of the input, not pad values. Thus, the -50dB setting is generally used with low output dynamic microphones, -40dB with medium output condenser microphones, and -20dB with electric instrument (preamplified) outputs, and low level (hi-fi) line sources. When properly set, the INPUT level switch provides the best combination of maximum headroom and minimum noise characteristics at the same time as it maintains a full range of volume control rotation.

5 LOW/HIGH-EQUALIZER

The LOW and HIGH-EQ controls alter the frequency response of the channel input, allowing you to achieve a variety of tonal characteristics. A maximum of $\pm 12\text{dB}$ of continuously variable, shelving type equalization is provided at 100Hz (LOW) and 10KHz (HIGH). Centering the controls provides flat audio response by defeating the equalization.

6 REVERB/ECHO VOLUME

This knob creates the mix (feeds the mix bus) that drives built-in or external Reverb/Echo effects or other devices.

7 AUXILIARY INPUT 1 & 2 VOLUME

These rotary controls set the levels of the incoming AUX IN 1 & 2 signals respectively. These controls permit the AUX IN signals to be balanced with the levels on the program mixing buses.

8 PROGRAM MASTER VOLUME

These controls adjust the left and right SPEAKER outputs respectively and also the headphone outputs.

9 AUXILIARY 1 & 2 OUTPUT SELECTOR SWITCHES

These selectors can be used to feed the AUX input to the left or right channel, or both, for the following outputs; SPEAKER, REC. OUT, PHONES.

REAR PANEL

10 REVERB/ECHO MASTER VOLUME

This rotary control sets the level of the signal from the FROM ECHO jack before it is mixed into both the program mixing buses, when the external devices such as echo machine etc. are connected to its jack. Or it sets the overall level of the signal through the internal reverberation unit from the reverb/echo mixing bus.

11 FROM ECHO JACK

This standard phone jack accepts output from an external echo device or from other high-impedance, line-level sources. Level is controlled by MASTER REVERB/ECHO. Use of this jack disconnects the internal REVERB spring.

12 TO ECHO JACK

This standard phone jack feeds the mixed signal from input channel REVERB/ECHO controls to an external echo device. Not affected by the MASTER REVERB/ECHO control, TO ECHO can be used as a mono auxiliary output (if desired, at the same time the built-in reverb is in use).

13 HEADPHONE OUTPUT JACK

This stereo phone jack is for connection of almost any stereo headphones (8-ohm or higher impedance). It derives the signal from each of the speaker outputs, but at lower levels. The headphone volume is controlled by each of the MASTER volume controls.

14 PHONO VOLUME

The rotary PHONO control regulates the PHONO input levels of both left and right channels and assigns the signals to both the left and right program mixing buses.

15 POWER SWITCH

This recessed, push-on, push-off switch controls the AC power to the EM-120. No audio passes through the mixer when power is off.

16 VU METERS

These meters provide a visual indication of the average audio level of the program buses. "0 VU" = 25 Watts RMS ("+3 VU" = 50 Watts RMS) when 8-ohm speakers are used. Both meters are illuminated when AC power is on.

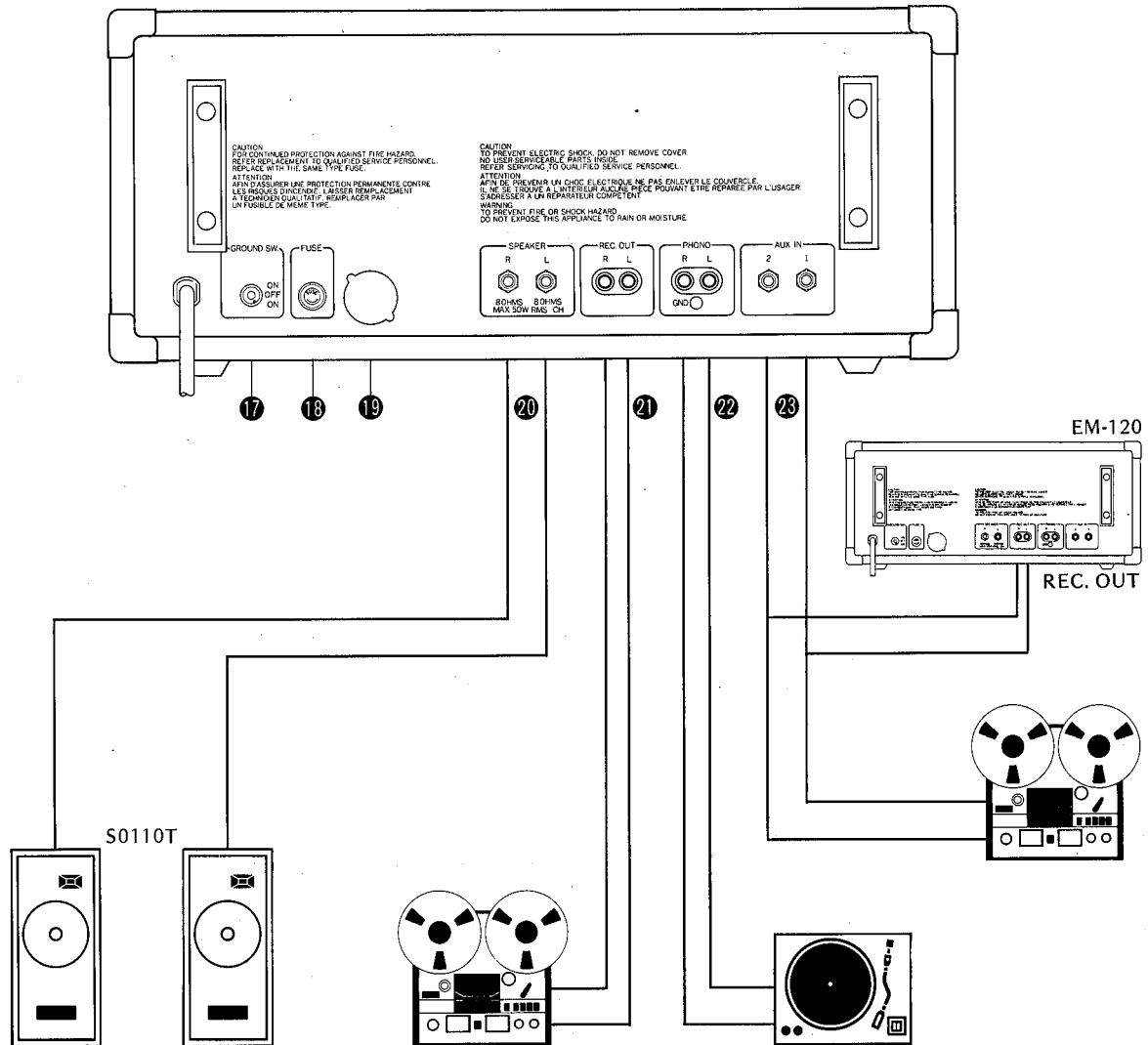

REAR PANEL

17 GROUND SWITCH

The toggle switch has two "on" and one "off" positions. Pick the one that provides the lowest hum level. (Provided only on US and Canadian models.)

18 FUSE HOLDER

This fuse protects the primary (AC line) side of the power supply. If a fuse blows, be sure to replace it with one of the same type and rating as noted on the panel.

19 VOLTAGE SELECTOR

Not provided in certain areas.

20 SPEAKER OUTPUT JACKS

These standard phone jacks are left and right program outputs, controlled by each MASTER Volume. They deliver up to 50 Watts RMS per channel into an 8-ohm minimum speaker load.

21 REC. OUT JACKS

These pin jacks are high-impedance, line-level outputs carrying the left and right program mix, but are independent of MASTER VOLUME. Thus, changes in the overall house mix level will not affect tape recordings.

22 PHONO JACKS

These pin jacks are provided to connect a stereo record player without using RIAA phono preamp, carrying the incoming signals to the program mixing buses.

23 AUXILIARY INPUT 1 & 2 JACKS

The AUX IN jacks are unbalanced phone jacks, and are high impedance, so they accept low or high-impedance sources. With a nominal input sensitivity of -20dB (78mV), these jacks are suitable for connection of hi-fi tape machines, many echo and reverb units, and some mixers. By turning down the AUX IN volume control, higher level sources may be connected to these jacks. Since the AUX IN volume controls are actually variable input attenuators, this does not result in a loss of headroom. AUX IN is also suitable for connection of hi-fi type RIAA turntable preamps, enabling records to be played without using input channels.

FOR THE BRITISH STANDARD MODELS

As the colours of the wires in the mains lead of the apparatus may not correspond with the coloured markings identifying the terminals in your plug proceed as follows. The wire which is coloured GREEN-and-YELLOW must be connected to the terminal in the plug which is marked by the letter E or by the safety earth symbol \perp or coloured GREEN or GREEN-and-YELLOW. The wire which is coloured BLUE must be connected to the terminal which is marked with the letter N or coloured BLACK. The wire which is coloured BROWN must be connected to the terminal which is marked with the letter L or coloured RED.

IMPORTANT:

The wires in the mains lead are coloured in accordance with the following code.

GREEN-and-YELLOW Earth
BLUE Neutral
BROWN Live

WARNING:

This apparatus must be earthed.

EM-120 SPECIFICATIONS

GENERAL SPECIFICATIONS

Number of Inputs	6 INPUT channels, 1 auxiliary stereo input (PHONO), 3 auxiliary monaural inputs (FROM ECHO, AUX IN 1 & 2)
Input Channel Controls	VOLUME, LOW-EQ, HIGH-EQ, REV./ECHO volume, INPUT LEVEL selector switch (-50/-40/-20dBm), OUTPUT selector switch (L/L+R/R)
Mixing Buses	2 program (stereo Left and Right), 1 Reverb/Echo
Number of Outputs	2 SPEAKER (L & R), 2 REC. OUT (L & R), 1 TO ECHO, 1 PHONES
Master Controls	MASTER volume (LEFT & RIGHT), PHONO volume, REVERB/ECHO master volume, AUX IN volume (1 & 2), AUX IN OUTPUT selector switch (L/L+R/R)
Reverb and Echo	Built-in Accutronics spring-type reverberation unit; provisions for connection of external reverb, echo delay or other devices
Power Output	100 Watts (2x50W) continuous average sine wave power into 8 ohms with less than 1% T.H.D. at 1KHz
Frequency Response	0±1dB (30Hz ~ 15KHz), +1dB, -3dB (20Hz ~ 30KHz)
Total Harmonic Distortion	Less than 0.1% at 2x35 Watts, 8 ohms (1KHz), Less than 0.2% at 2x35 Watts, 8 ohms (30Hz ~ 10KHz)
Intermodulation Distortion	Less than 0.2% using frequencies of 70Hz and 7KHz, mixed in a ratio of 4:1, single channel power output of 20 Watts into 8 ohms
Hum & Noise (20Hz ~ 20KHz)	-118dBm equivalent input noise (150-ohm termination), -62dB (0.62mV, 90dB S/N) master volume at maximum and all input volume at minimum, -40dB (7.8mV, 68dB S/N) master volume and one input volume at maximum

Maximum Voltage Gain (at 1KHz)	SPEAKER 78dB (INPUT channel to SPEAKER), TO ECHO 30dB (INPUT channel to TO ECHO), REC. OUT 47dB (INPUT channel to REC. OUT), AUX IN 48dB (AUX IN to SPEAKER), PHONO 81dB (PHONO to SPEAKER)
Maximum Input Level (at 1KHz)	INPUT channel +18dB (6.2V) Input Level Switch: "-20", INPUT channel -12dB (0.2V) Input Level Switch: "-50", PHONO -12dB (0.2V)
Maximum Output Level (at 1KHz)	SPEAKER 50 Watts into 8 ohms both channels driven, REC. OUT +15dB (4.36V), TO ECHO -2dB (0.62V)
Equalization	LOW: 12dB shelving at 100Hz, HIGH: 12dB shelving at 1KHz
Level Indicators	2 illuminated VU meters; 0 VU=25 Watts (8-ohm termination)
Power Requirements	110, 120, 130, 220 or 240V AC, 50/60Hz, 120V 1.8A (Canadian model), 330W (other models)
Physical Dimensions (WxHxD)	514x210x265mm (20-1/4x8-1/4x10-3/8")
Net Weight	12Kg (26.5lbs.)
Finish	Black leatherette
Additional Features	2-way ground switch (US & Canadian models only), Integral carrying strap, reinforced corners, power cord binders on rear panel

CONNECTOR, LEVEL & IMPEDANCE INFORMATION

Circuit	Type Connector*	Nominal Level	Impedance
Inputs			(Actual)
INPUT (1 ~ 6)	standard phone (x6)	-50dB (2.5mV)	10 Kohms
		-40dB (7.8mV)	
		-20dB (78mV)	
AUX IN (1, 2)	standard phone (x2)	-20dB (78mV)	30 Kohms
		PHONO (L, R)	pin jack (x2)
FROM ECHO	standard phone	-30dB (25mV)	30 Kohms
Outputs			(Nominal Load)
SPEAKER (L, R)	standard phone (x2)	50 Watts RMS	8 ohms
REC. OUT (L, R)	pin jack (x2)	-3dB (550mV)	50 Kohms
TO ECHO	standard phone	-20dB (78mV)	50 Kohms
PHONES	stereo phone	(varies w/SPEAKER)	8 ohms

*All connections are unbalanced.

In these specifications, when dB represents a specific voltage, 0dB is referenced to 0.775V. Specifications subject to change without notice.

BLOCK DIAGRAM

EM-120 Block Diagram

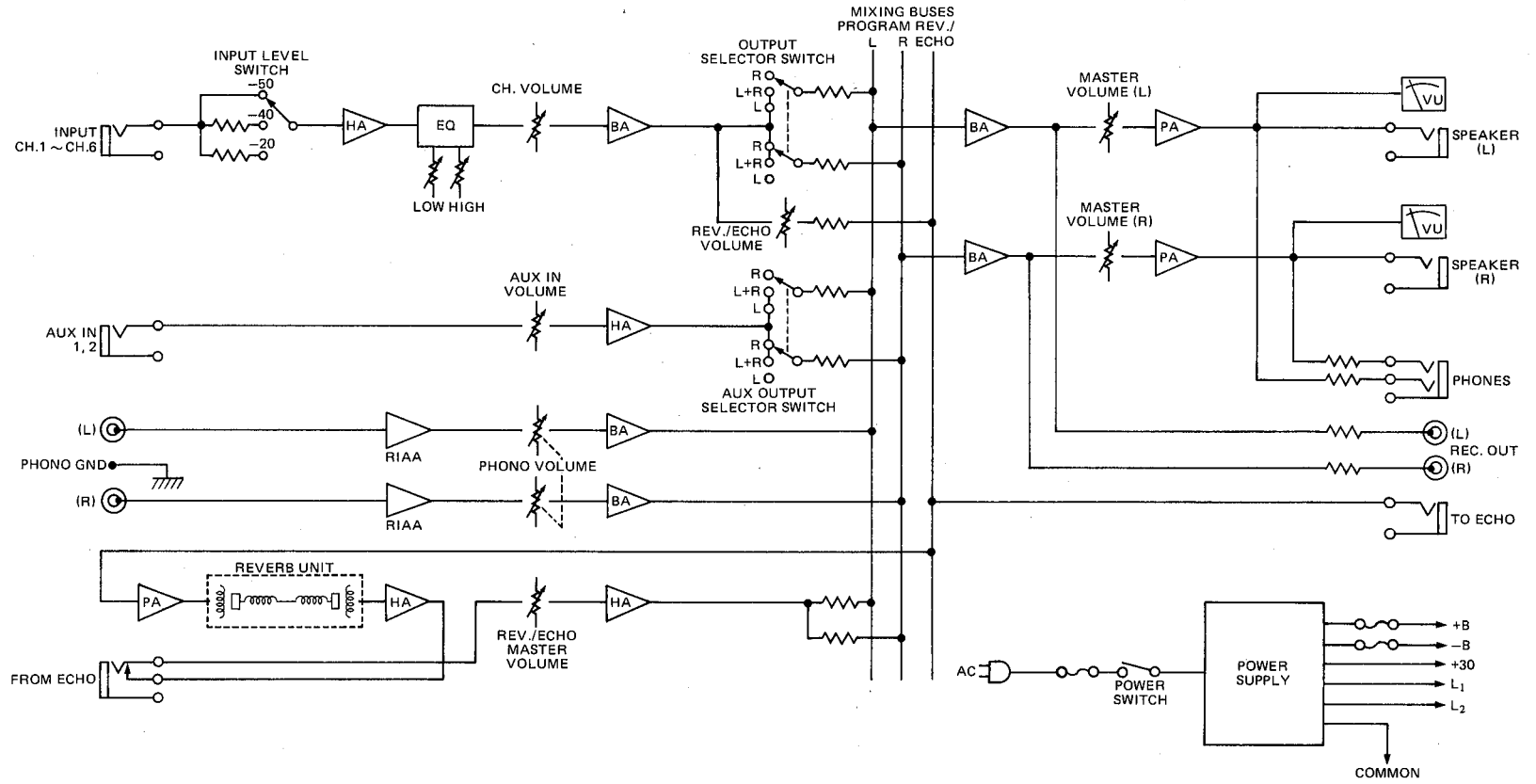

FREQUENCY RESPONSE

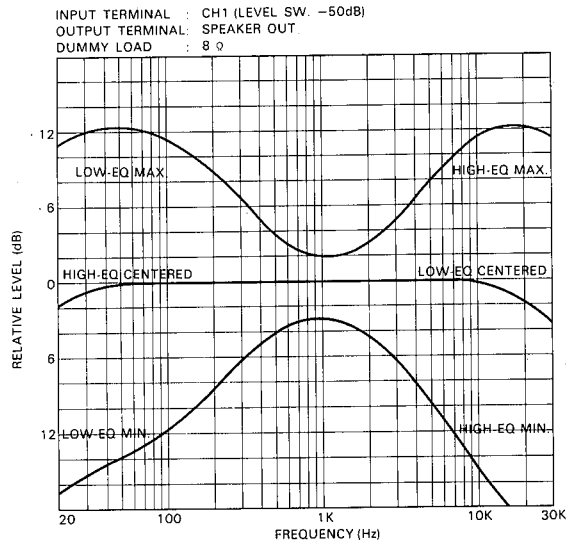

REGARDING DESIGNATION OF INPUT AND OUTPUT LEVELS

In these specifications, when dB represents a specific voltage, 0dB is referenced to 0.775V. "dB" is a voltage level, whereas "dBm" is a power level. 0dBm is referenced to 1 milliwatt (0.775V driving a 600 ohm termination). For example, when 12.3V is fed to a high impedance, the level is designated "+24dB." When +24dB (12.3V) drives a 600 ohm termination, the level is designated "+24dBm."

If the voltage remains the same when the termination changes, the power level changes; +24dB (voltage) driving a 300 ohm termination would be +27dBm (power), and +24dB driving a 150 ohm termination would be +30dBm. The level in "dB" is specified, wherever applicable, (1) to avoid confusion when the mixer is connected to various low impedance circuits, and (2) to be more accurate in specifying levels across high impedance circuits.

TOTAL HARMONIC DISTORTION

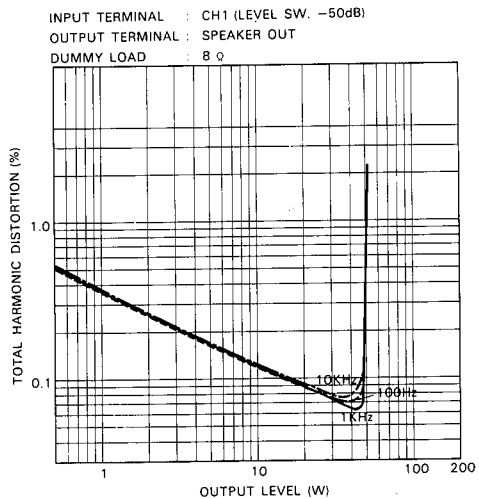

SINCE 1887  **YAMAHA**
NIPPON GAKKI CO., LTD. HAMAMATSU, JAPAN