



RX-V595aRDS

Natural Sound AV Receiver

Ampli-Tuner audio-vidéo

**OWNER'S MANUAL
MODE D'EMPLOI
BEDIENUNGSANLEITUNG
BRUKSANVISNING
MANUALE DI ISTRUZIONI
MANUAL DE INSTRUCCIONES
GEBRUIKSAANWIJZING**

SUPPLIED ACCESSORIES
ACCESSOIRES FOURNIS
MITGELIEFERTE ZUBEHÖRTEILE
MEDFÖLJANDE TILLBEHÖR
ACCESSORI IN DOTAZIONE
ACCESORIOS INCLUIDOS
BIJGELEVERDE ACCESSOIRES

- After unpacking, check that the following parts are included.
- Après le déballage, vérifier que les pièces suivantes sont incluses.
- Nach dem Auspacken überprüfen, ob die folgenden Teile vorhanden sind.
- Kontrollera efter uppäckningen att följande delar finns med.
- Verificare che tutte le parti seguenti siano contenute nell'imballaggio dell'apparecchio.
- Desembalar el aparato y verificar que los siguientes accesorios están en la caja.
- Controleer na het uitpakken of de volgende onderdelen voorhanden zijn.

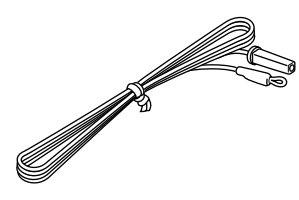
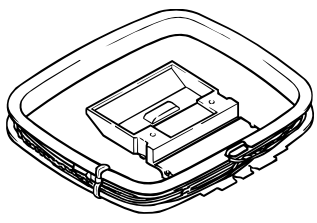
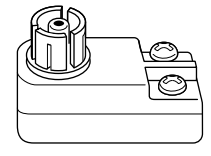
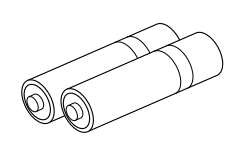
<ul style="list-style-type: none"> • Indoor FM Antenna • Antenne FM intérieure • UKW-Innenantenne • Inomhus-FM-antenn • Antenna FM interna • Antena FM interior • FM-binnenantenne 	
<ul style="list-style-type: none"> • AM Loop Antenna • Cadre-antenne AM • MW-Rahmenantenne • AM-ramantenn • Antenna AM ad anello • Antena de cuadro de AM • AM-raamantenne 	
<ul style="list-style-type: none"> • 75-ohm/300-ohm antenna adapter (U.K. model only) • Adaptateur d'antenne 75 ohms/300 ohms (Modèle Royaume-Uni seulement) • 75-Ohm/300-Ohm Antennenstecker (nur Großbritannien-Modell) • 75 ohm/300 ohm antennadapter (gäller endast modellen för Storbritannien) • Adattatore per antenna da 75/300 ohm (Soltanto il modello per la Gran Bretagna) • Adaptador de antena de 75-ohmios/300-ohmios (Sólo el modelo para el Reino Unido) • 75 ohm/300 ohm antenneadapter (Alleen modellen voor Verenigd Koninkrijk) 	
<ul style="list-style-type: none"> • Batteries (size AA, R6, UM-3) • Piles (taille AA, R6, UM-3) • Batterien (Größe AA, R6, UM-3) • Batterier (storlek AA, R6, UM-3) • Batterie (formato AA, R6, UM-3) • Pilas (tamaño AA, R6, UM-3) • Batterijen (maat AA, R6, UM-3) 	

- Remote control
 Before using the remote control, install the supplied batteries. See page 49 for battery installation.
- Télécommande
 Avant d'utiliser la télécommande, mettre les piles fournies en place. Pour la mise en place des piles, voir page 101.
- Fernbedienung
 Legen Sie vor Gebrauch der Fernbedienung die mitgelieferten Batterien ein. Angaben zum Einlegen der Batterien finden Sie auf Seite 155.
- Fjärrkontroll
 Sätt i de medföljande batterierna innan du använder fjärrkontrollen. Se sidan 207 om hur man sätter i dem.
- Telecomando
 Prima di usare il telecomando, installare le batterie in dotazione. Per l'installazione delle batterie vedere a pagina 259.
- Control remoto
 Antes de utilizar el transmisor de control remoto, instálele las pilas suministradas. Para instalar las pilas, consulte la página 311.
- Afstandsbediening
 Alvorens u de afstandsbediening gaat gebruiken, moet u de bijgeleverde batterijen plaatsen. Zie blz. 363 voor het plaatsen van de batterijen.

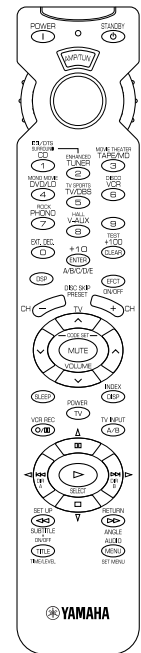

FEATURES

5-Channel Power Amplification

Minimum RMS Output
(0.04% THD, 20 Hz – 20 kHz)

Main: 65 W + 65 W (8 Ω)

Center: 65 W (8 Ω)

Rear: 65 W + 65 W (8 Ω)

Multi-mode Digital Sound Field Processing

- Digital Sound Field Processor (DSP)
- Dolby Digital Decoder
- Dolby Pro Logic Decoder
- DTS Decoder
- CINEMA DSP: Theater-like Sound Experience by the Combination of YAMAHA DSP Technology and Dolby Digital, Dolby Pro Logic or DTS
- Automatic Input Balance Control for Dolby Pro Logic decoding

- Test Tone Generator for Easier Speaker Balance Adjustment

- Speaker Output Mode Selection

Sophisticated FM/AM Tuner

- 40-Station Random Access Preset Tuning
- Automatic Preset Tuning
- Preset Station Shifting Capability (Preset Editing)
- 6-Channel External Decoder Input for Other Future Formats
- Video Signal Input/Output Capability (Including S Video Connections)
- SLEEP Timer
- Universal Remote Control with Preset Manufacturer Codes

CONTENTS

SUPPLIED ACCESSORIES	2
FEATURES	3
CAUTION	4

● Introduction

FEATURES OF THE SOUND EFFECTS	5
CONTROLS AND THEIR FUNCTIONS	8

● Preparation

SPEAKER SETUP	11
CONNECTIONS	12
ADJUSTMENTS BEFORE USING THIS UNIT	19

● Basic Operation

BASIC OPERATION	24
TUNING	28
RECEIVING RDS STATIONS	33
SETTING THE SLEEP TIMER	36

● Information about DSP

SOUND FIELD PROGRAM	37
---------------------------	----

● Advanced Information

ADJUSTMENTS IN THE "SET MENU" MODE	42
--	----

● Remote control

REMOTE CONTROL	44
SETUP CODES	50

TROUBLESHOOTING	51
SPECIFICATIONS	54

LIST OF MANUFACTURERS' CODES	369
------------------------------------	-----

CAUTION: READ THIS BEFORE OPERATING YOUR UNIT.

1. To assure the finest performance, please read this manual carefully. Keep it in a safe place for future reference.
2. Install this unit in a cool, dry, clean place – away from windows, heat sources, sources of excessive vibration, dust, moisture and cold. Avoid sources of humming (transformers, motors). To prevent fire or electrical shock, do not expose the unit to rain or water.
3. Never open the cabinet. If something drops into the set, contact your dealer.
4. Do not use force on switches, controls or connection wires. When moving the unit, first disconnect the power plug and the wires connected to other equipment. Never pull the wires themselves.
5. The openings on the cover assure proper ventilation of the unit. If these openings are obstructed, the temperature inside the unit will rise rapidly. Therefore, avoid placing objects against these openings, and install the unit in a well-ventilated area to prevent fire and damage.

Be sure to allow a space of at least 20 cm behind, 20 cm on both sides and 30 cm above the top panel of the unit to prevent fire and damage.
6. The voltage used must be the same as that specified on this unit. Using this unit with a higher voltage than specified is dangerous and may result in fire or other accidents. YAMAHA will not be held responsible for any damage resulting from the use of this unit with a voltage other than that specified.
7. Digital signals generated by this unit may interfere with other equipment such as tuners, receivers and TVs. Move this unit farther away from such equipment if interference is observed.
8. Always set the VOLUME control to “∞” before starting the audio source play. Increase the volume gradually to an appropriate level after playback has been started.
9. Do not attempt to clean the unit with chemical solvents; this might damage the finish. Use a clean, dry cloth.
10. Be sure to read the “TROUBLESHOOTING” section regarding common operating errors before concluding that the unit is faulty.
11. When not planning to use this unit for a long period of time (e.g., a vacation), disconnect the AC power plug from the wall outlet.
12. To prevent lightning damage, disconnect the AC power plug and disconnect the antenna cable when there is an electrical storm.
13. Grounding or polarization – Precautions should be taken so that the grounding or polarization of the unit is not defeated.
14. AC outlet
Do not connect audio equipment to the AC outlet on the rear panel if that equipment requires more power than the outlet is rated to provide.

This unit is not disconnected from the AC power source as long as it is connected to the wall outlet, even if this unit itself is turned off. This state is called the standby mode. In this state, this unit is designed to consume a very small quantity of power.

For U.K. customers

If the socket outlets in the home are not suitable for the plug supplied with this appliance, it should be cut off and an appropriate 3 pin plug fitted. For details, refer to the instructions described below.

Note: The plug severed from the mains lead must be destroyed, as a plug with bared flexible cord is hazardous if engaged in a live socket outlet.

Special Instructions for U.K. Model

IMPORTANT

THE WIRES IN MAINS LEAD ARE COLOURED IN ACCORDANCE WITH THE FOLLOWING CODE:

Blue: NEUTRAL

Brown: LIVE

As the colours of the wires in the mains lead of this apparatus may not correspond with the coloured markings identifying the terminals in your plug, proceed as follows:
The wire which is coloured BLUE must be connected to the terminal which is marked with the letter N or coloured BLACK. The wire which is coloured BROWN must be connected to the terminal which is marked with the letter L or coloured RED.
Making sure that neither core is connected to the earth terminal of the three pin plug.

FEATURES OF THE SOUND EFFECTS

Introduction

Welcome to the exciting world of digital home entertainment. This unit is one of the most complete and advanced AV receivers available. Some of the more advanced features may not be familiar to you, but they are easy to use. State-of-the-art technologies such as Dolby Digital and Digital Theater Systems (DTS) may be new to your home, but you have probably experienced the amazing realism they bring to feature films in theaters around the world.

To make the listening experience even more enjoyable, this unit includes a number of exclusive, digitally created listening environments known as digital sound fields. Choosing a sound field program is like transporting yourself to such venues as an outdoor arena, a European church, or a cozy jazz club. Take some time now to read more about these features and enjoy the new experiences this unit brings to your home theater.

Digital Sound Field Processing

What is it that makes live music so good? Today's advanced sound reproduction technology lets you get extremely close to the sound of a live performance, but the chances are that you'll still notice something missing — the acoustic environment of the live concert hall. Extensive research into the exact nature of the sonic reflections that create the ambience of a large hall has made it possible for YAMAHA engineers to bring you this same sound to your listening room, so you'll feel all the sound of a live concert.

Furthermore, our technicians, armed with sophisticated measuring equipment, have even made it possible to capture the acoustics of a variety of actual concert halls, theaters, etc. from around the world, to allow you to accurately re-create any one of these live performance environments, all in your own home.

Dolby Pro Logic

Dolby Surround has been used in movie theaters since the mid-seventies. It has also been available in home entertainment systems since the late eighties and continues to be a popular format for home theater systems. It uses four discrete channels and five speakers to reproduce realistic and dynamic sound effects: two main channels (left and right), a center channel for dialog, and a rear channel for special sound effects. The rear channel reproduces sound within a narrow frequency range.

Most video tapes and laser discs include Dolby Surround encoding, as do many TV and cable broadcasts. The Dolby Pro Logic decoder built into this unit employs a digital signal processing system that stabilizes each channel for even more accurate sound positioning than is available with standard analog processors.

Dolby Digital

Dolby Digital is the next level of the Dolby Surround sound system that was developed for 35 mm-film movies by employing low bit-rate audio coding.

Dolby Digital is a digital surround sound system that provides completely independent multi-channel audio to you. Dolby Digital provides five full-range channels in what is sometimes referred to as a "3/2" configuration: three front channels (left, center and right), and two surround channels. A sixth bass-only effect channel is also provided for output of LFE (low frequency effect), or low bass effects that are independent of other channels. (This is called the "LFE channel".) This channel is counted as 0.1, thus giving rise to the term 5.1 channels in total.

Compared to Dolby Surround, which is referred to a "3/1" system (left front, center, right front and just one surround channel), Dolby Digital features two surround channels, called stereo or split surrounds, each offering the same full-range fidelity as the three front channels.

By using the built-in Dolby Digital decoder, you can experience the dramatic realism and impact of Dolby Digital theater sound in your home.

The wide dynamic range of sound reproduced by the five full-range channels and precise sound orientation by digital sound processing provides listeners with excitement and realism that have never been experienced before.

Dolby Digital forms 5.1 channels as already mentioned, but it can also form fewer channels, for example 2-channel stereo and monaural. You may be able to find some 2-channel stereo and/or monaural sources encoded with Dolby Digital in the market.

Laser disc and DVD are home audio/video program sources that could benefit from Dolby Digital. In the near future, Dolby Digital will also be applied to DBS, CATV and HDTV. The ongoing release of Dolby Digital theatrical films now underway will provide an immediate source of Dolby Digital encoded video software.



Manufactured under license from Dolby Laboratories. "Dolby", "Pro Logic" and the double-D symbol are trademarks of Dolby Laboratories.

DTS Digital Surround

DTS (Digital Theater Systems) was developed to replace analog soundtracks of movies with six discrete channels of digital soundtracks, and it is now installed in many theaters around the world. The DTS digital playback system changed the way we experienced movies in theaters with six discrete channels of superb digital audio.

DTS technology, through intense research and development has made it possible to deliver similar encode/decode discrete technology to home audio surround-sound entertainment. DTS Digital Surround is an encode/decode system which delivers six channels of master-quality, 20-bit audio; technically, it is 5.1 channels, which means 5 full-range (left, center, right and two surround) channels, plus a subwoofer (LFE) channel (as "0.1"). It is compatible with the 5.1 speaker configurations that are currently available for home theater systems.

The DTS Digital Surround algorithm is designed to encode the six channels of 20-bit audio on to some laser discs, compact discs and DVDs with considerably less data compression.

By using the DTS decoder built into this unit, you can experience the dramatic realism and impact of the DTS-installed theater's high quality sound in your home.

Laser disc, compact disc and DVD are home audio formats by which DTS can present its high-quality multi-channel audio. (In addition to movies on laser discs, many exciting new multi-channel music recordings will also become available in the form of DTS-encoded compact discs.)



Manufactured under license from Digital Theater Systems, Inc. US Pat. No. 5,451,942 and other world-wide patents issued and pending. "DTS", "DTS Digital Surround", are trademarks of Digital Theater Systems, Inc. Copyright 1996 Digital Theater Systems, Inc. All Rights Reserved.

CINEMA DSP: Dolby Surround + DSP / DTS + DSP

The Dolby Surround sound and DTS systems show their full ability in a large movie theater, because movie sounds are originally designed to be reproduced in a large movie theater that uses a multitude of speakers. Trying to create a sound environment similar to that of a movie theater in your home is difficult because of the room size, material inside the walls, the number of speakers, and so on. In other words, your listening room is very different from a movie theater.

However, YAMAHA DSP technology allows you to create nearly the same sound experience as that of a large movie theater in your home by compensating for the lack of presence and dynamics in the listening room with original digital sound fields combined with Dolby Surround or DTS Digital Surround sounds.

CINEMA DSP

The YAMAHA "CINEMA DSP" logo indicates those programs that are created by the combination of YAMAHA DSP technology and Dolby Surround or DTS.

Dolby Pro Logic + 2 Digital Sound Fields

Digital sound fields are created on the presence side and the rear surround side of the Dolby Pro Logic-decoded sound field, respectively. They create a wide acoustic environment and emphasize the surround effect in the room, letting you feel as much presence as if you were watching a movie in a popular Dolby Stereo theater.

Refer to pages 37 to 38 for the DSP program.

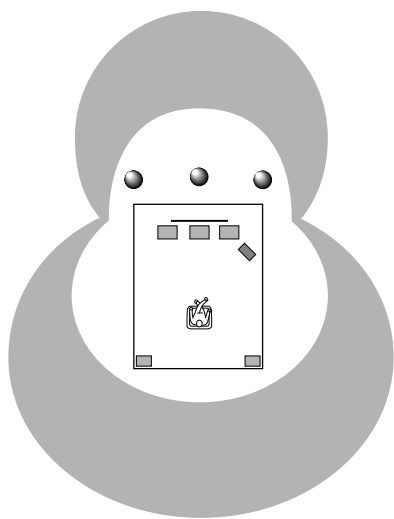

Dolby Digital or DTS + 3 Digital Sound Fields

Digital sound fields are created on the presence side and the independent left and right surround sides of the Dolby Digital-decoded or DTS-decoded sound field, respectively. They create a wide acoustic environment and strong surround effect in the room without losing high-channel separation. With the wide dynamic range of Dolby Digital or DTS sound, this sound field combination lets you feel as if you were watching a movie in the newest Dolby Digital theater or DTS-installed theater. This is the most ideal home theater sound at the present time.

Refer to pages 37 to 38 for the DSP program.

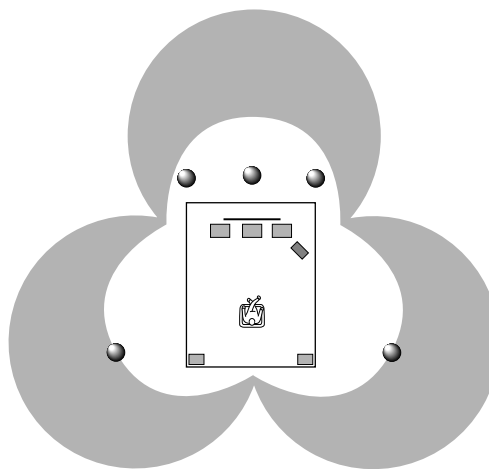

CONTROLS AND THEIR FUNCTIONS

FRONT PANEL

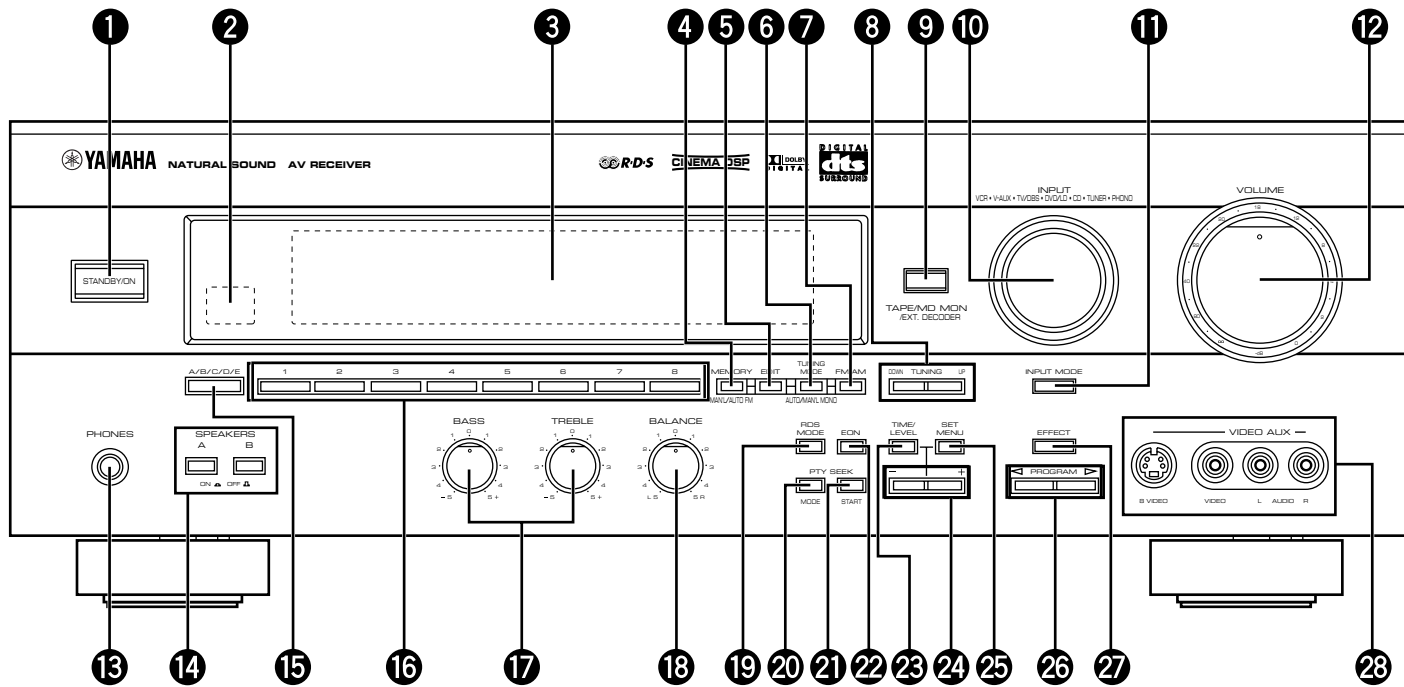

Refer to pages 44 to 49 for the remote control.

1 STANDBY/ON

Press this switch to turn on the power of this unit. Press it again to set this unit in the standby mode.

Standby mode
In this state, this unit consumes a very small quantity of power to receive infrared-signals from the remote control.

2 Remote control sensor

This receives signals from the remote control.

3 Display

This shows various information. (Refer to page 10 for details.)

4 MEMORY (MAN'L/AUTO FM)

Press this button to store the broadcasting stations. When this button is pressed and held for more than three seconds, automatic preset tuning begins.

5 EDIT

This button is used to exchange the assignment of two preset stations with each other.

6 TUNING MODE (AUTO/MAN'L MONO)

Press this button to switch the tuning mode to automatic or manual. To select the automatic tuning mode, press this button so that the "AUTO TUNING" indicator lights up on the display. To select the manual tuning mode, press this button so that the "AUTO TUNING" indicator goes off.

7 FM/AM

Press this button to switch the reception band between FM and AM.

8 TUNING UP/DOWN

This button is used for tuning. Press the UP side to tune in to higher frequencies, and press the DOWN side to tune in to lower frequencies.

When this unit is in the PTY SEEK mode, press this button to change the currently selected program type.

9 TAPE/MD MON / EXT. DECODER

Press this button to play a tape or an MD. The "TAPE/MD MON" indicator lights up on the display. When you press the button next, the "TAPE/MD MON" indicator goes off, "EXT. DECDR" appears on the display and you can play the signal connected to the **EXTERNAL DECODER INPUT** terminals.

10 INPUT

Turn this selector to select the input source (VCR, VIDEO AUX, TV/DBS, DVD/LD, CD, TUNER, PHONO) that you want to listen to or watch.

The name of the selected input source appears on the display.

11 INPUT MODE

This button switches between the DVD/LD and TV/DBS input signal modes.

12 VOLUME

This control is used to raise or lower the volume level.

13 PHONES jack

When you use headphones, connect the headphones to the **PHONES** jack. You can listen to the sound to be output from the main speakers through the headphones.

When using headphones only, set both **SPEAKERS A** and **B** to the OFF position and switch off the digital sound field processor (so that no DSP program name appears on the display) by pressing **EFFECT**.

14 SPEAKERS

Set **A** or **B** (or both **A** and **B**) to the ON position for the main speaker system (connected to this unit) that you want to use. Set the button(s) for the main speaker system you don't want to use to the OFF position.

15 A/B/C/D/E

Press this button to select one of a group (A to E) of preset stations.

16 Preset station number selector

Each of these buttons selects a preset station number (1 to 8).

17 Tone controls

These controls are only effective for the sound from the main speakers.

BASS

Use this control to increase or decrease the low-frequency response. The "0" position produces a flat response.

TREBLE

Use this control to increase or decrease the high-frequency response. The "0" position produces a flat response.

18 BALANCE

This control is only effective for the sound from the main speakers.

Turn the control to adjust the balance of the output volume to the left and right speakers to compensate for sound imbalance caused by the speaker location or listening room conditions.

19 RDS MODE

When an RDS station is received, pressing this button changes the display mode into the PS mode, PTY mode, RT mode and/or CT mode (if the station employs those RDS data services) in turn.

20 PTY SEEK MODE

When this button is pressed, the unit is set in the PTY SEEK mode.

21 PTY SEEK START

Press this button to begin searching for a station after the desired program type has been selected in the PTY SEEK mode.

22 EON

Press this button to select the desired program type (NEWS, INFO, AFFAIRS, SPORT) when you want to call a radio program of that type automatically.

23 TIME/LEVEL

Press this button to select the item in the TIME/LEVEL mode.

24 +/-

These buttons are used to adjust the settings of the SET MENU mode and the TIME/LEVEL mode. In the TIME/LEVEL mode, press **+** to increase the delay time or speaker output level. Press **-** to decrease the delay time or speaker output level.

25 SET MENU

Press this button to select functions in the SET MENU mode.

26 PROGRAM selector

Press **<** or **>** to select a DSP program.

The name of the selected program appears on the display.

27 EFFECT

Press this button once to switch the effect speakers (center and rear) on or off. If you turn off the effect by using **EFFECT**, all Dolby Digital and DTS audio signals are directed to the main left and right channels. In that case, the left and right channel signal levels may not match.

28 VIDEO AUX terminals

Connect an auxiliary video or audio input source such as a camcorder to these terminals. If the connected video unit has an S video output terminal, connect it to the **S VIDEO** terminal to obtain a high-resolution picture. The source connected to these terminals can be selected by **INPUT**.

DISPLAY PANEL

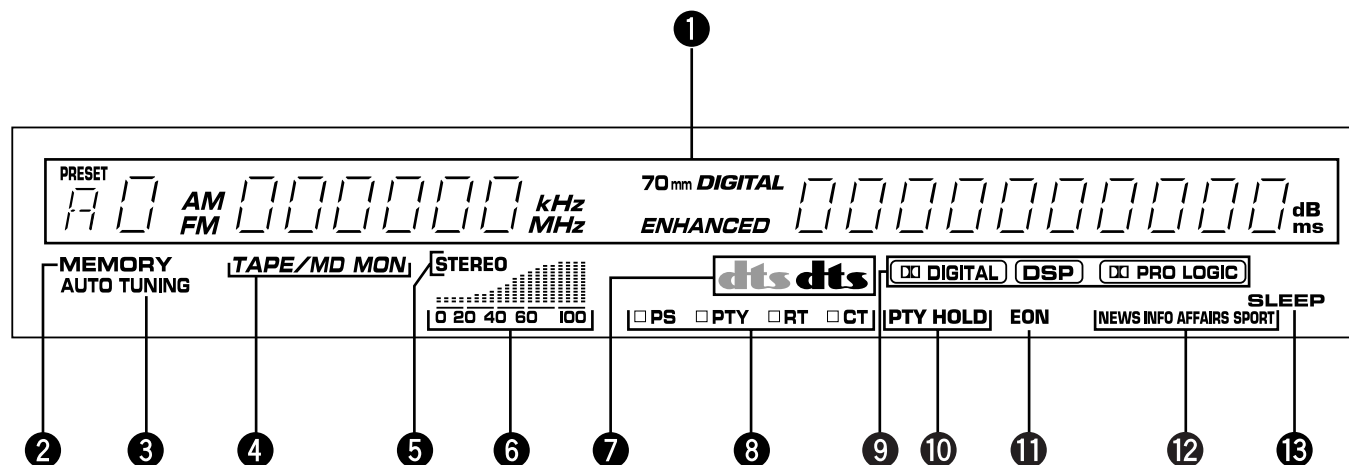

1 Multi-information display

This displays various information, for example the station frequency, preset station number and name of the selected input source.

2 MEMORY indicator

When **MEMORY** is pressed, this indicator flashes for about five seconds. During this period, the displayed station can be stored in the memory.

3 AUTO TUNING indicator

This lights up when the unit is in the automatic tuning mode.

4 TAPE/MD MON indicator

This lights up when the tape deck (or MD recorder, etc.) is selected as the input source by pressing **TAPE/MD MON / EXT. DECODER** on the front panel or **TAPE/MD** on the remote control.

5 STEREO indicator

This lights up when an FM stereo broadcast with sufficient signal strength is being received.

6 Signal-level indicator

This indicates the signal level of the station being received. If multipath interference is detected, the indication decreases.

7 dts indicators

Either "dts" indicator lights up when the built-in DTS decoder is turned on.

The red "dts" indicator lights up when playing a CD or LD encoded with DTS.

The orange "dts" indicator lights up when playing a DVD encoded with DTS.

* An orange "dts" indicator may light up when playing a CD or LD encoded with DTS after playing a video-CD or DVD on a DVD/LD combi-player.

8 RDS mode indicators

The name(s) of the RDS mode(s) employed by the currently received RDS station light(s) up. Illumination of one of the named indicators shows that the corresponding RDS mode is now selected.

9 DIGITAL, DSP and PRO LOGIC indicators

"DIGITAL" lights up when the built-in Dolby Digital decoder is on and the signals of the selected source encoded with Dolby Digital are not in 2-channel. "DSP" lights up when the built-in digital sound field processor is on, and "PRO LOGIC" lights up when the built-in Dolby Pro Logic decoder is on. Depending on the selected DSP program, both "DIGITAL" and "DSP", or both "DSP" and "PRO LOGIC" will light up.

10 PTY HOLD indicator

This lights up while a search is being performed in the PTY SEEK mode.

11 EON indicator

This lights up when an RDS station that employs the EON data service is being received.

12 Program type name indicators

The name selected in the EON mode lights up.

13 SLEEP indicator

This lights up while the built-in SLEEP timer is functioning.

SPEAKER SETUP

SPEAKERS TO BE USED

This unit is designed to provide the best sound-field quality with a 5-speaker configuration, using main speakers, rear speakers and a center speaker.

The main speakers are used for the main source sound plus the effect sounds. They will probably be the speakers from your present stereo system. The rear speakers are used for the effect and surround sounds, and the center speaker is for the center sounds (dialog, vocals, etc.). If for some reason it is not practical to use a center speaker, you can do without it. Best results, however, are obtained with the full system.

The main speakers should be high-performance models and have enough power-handling capacity to accept the maximum output of your audio system.

The other speakers do not have to be equal to the main speakers. For precise sound localization, however, it is ideal to use high-performance models that can reproduce sounds over the full range for the center speaker and the rear speakers.

Use of a subwoofer expands your sound field

It is also possible to further expand your system with the addition of a subwoofer. The use of a subwoofer is effective not only for reinforcing bass frequencies from any or all channels, but also for reproducing the LFE (low frequency effect) sound with high fidelity when playing back a source that is Dolby Digital or DTS-decoded. The YAMAHA Active Servo Processing Subwoofer System is ideal for natural and lively bass reproduction.

SPEAKER PLACEMENT

Refer to the following diagram when you place the speakers.

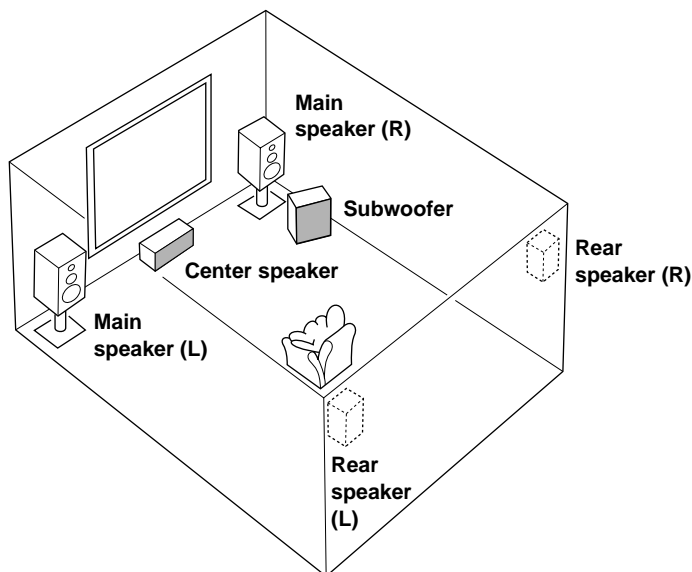

Main: The position of your present stereo speaker system.

Rear: Behind your listening position, facing slightly inward. Nearly 1.8 m (approx. 6 feet) up from the floor.

Center: Precisely between the main speakers. (To avoid interference with TV sets, use a magnetically shielded speaker.)

Subwoofer: The position of the subwoofer is not as critical, because low bass tones are not highly directional.

Note: If the center speaker (principally, it reproduces dialog, vocals, etc.) is not used, the sound will be output from the left and right main speakers. In that case, be sure to select the NONE position for "CNTR" in the SET MENU mode. (See page 19 for details.)

CONNECTIONS

Never plug in this unit and other components until all connections have been completed.

CONNECTIONS WITH OTHER COMPONENTS

Use RCA-type pin plug cables for connecting audio/video components with the exception described later.

When making connections between this unit and other components, be sure all connections are made correctly, that is to say L (left) to L, R (right) to R, “+” to “+” and “-” to “-”. Also, refer to the owner’s manual for each component to be connected to this unit.

* If you have YAMAHA components numbered as 1, 3, 4, etc. on the rear panel, connections can be made easily by making sure to connect the output (or input) terminals of each component to the same-numbered terminals of this unit.

*¹ AC OUTLET(S) (SWITCHED)

Europe model 2 OUTLETS

U.K. model 1 OUTLET

Use these to connect the power cords from your components to this unit.

The power to the **AC OUTLET(S)** is controlled by this unit’s **STANDBY/ON** or the provided remote control’s **POWER** and **STANDBY**. These outlets will supply power to any connected component whenever this unit is turned on.

The maximum power (total power consumption of components) that can be connected to the **AC OUTLET(S)** is 100 watts.

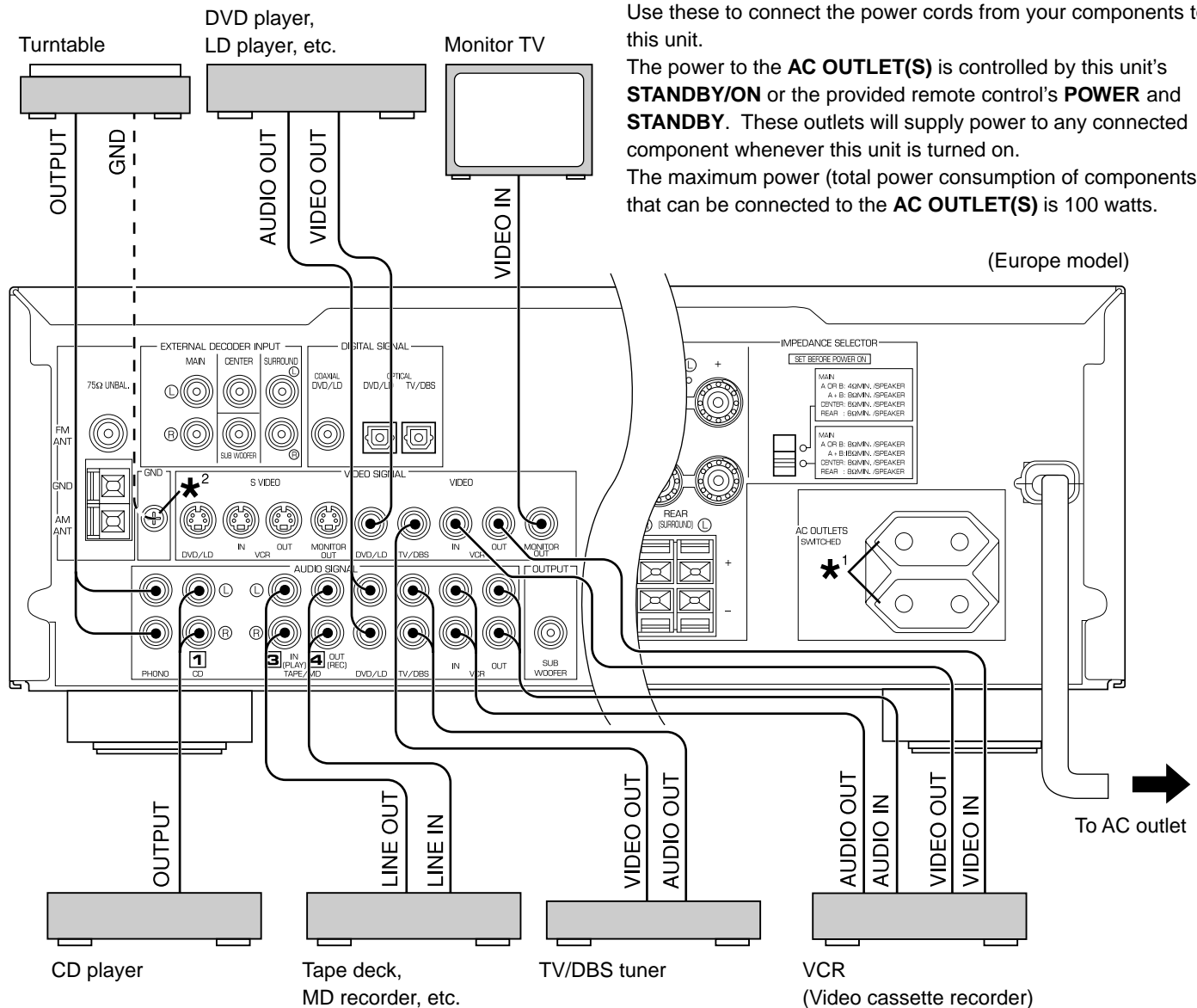

*² GND terminal (for turntable use)

Connecting the ground (earth) wire of the turntable to the **GND** terminal will normally minimize hum, but in some cases, better results may be obtained with the ground wire disconnected.

CONNECTING TO DIGITAL (COAXIAL AND/OR OPTICAL) TERMINALS

If your DVD (LD) player, TV/DBS tuner, etc. are equipped with coaxial or optical digital audio signal output terminals, they can be connected to this unit's **COAXIAL** and/or **OPTICAL** digital signal input terminals.

Digital audio signals are transmitted with less loss than analog audio signals. In addition, digital audio signal connections are necessary, especially for an LD player or a DVD player, to send signals encoded with Dolby Digital or DTS to this unit.

To make a connection between optical digital audio signal terminals, remove the cover from each terminal, and then connect them by using a commercially available optical fiber cable that conforms to EIAJ standards. Other cables might not function correctly.

Even if you connect an audio/video unit to the **COAXIAL** (or **OPTICAL**) terminal of this unit, you must keep the unit connected with the same-named analog audio signal terminals of this unit, because a digital signal cannot be recorded by a tape deck, MD recorder or VCR connected to this unit. You can easily switch the selection of input signals between "digital" and "analog." (See page 26 for details.)

Notes

- When connecting an audio/video unit to both the digital and analog terminals of this unit, make sure to connect between both terminals of the same name.
- Be sure to attach the covers when the **OPTICAL** terminals are not being used in order to protect them from dust.
- The input signal from the DVD/LD input terminals is selected in the following order of priority with the input mode set to the AUTO position:
 - 1 **COAXIAL** terminal
 - 2 **OPTICAL** terminal
 - 3 Analog terminal
- If the DIGITAL OUT data of the player has been processed in any way, you may not be able to perform DTS playback even if you make a digital connection between this unit and the player.
- All digital audio signal input terminals are applicable to sampling frequencies of 32 kHz, 44.1 kHz and 48 kHz.

No sound will be generated when connecting your LD player's Dolby Digital RF signal output terminal directly to this unit's **COAXIAL DVD/LD** digital signal input terminal.

DVD or LD player*

* If your LD player has a Dolby Digital RF signal output terminal, be sure to use the RF demodulator (separately purchased).

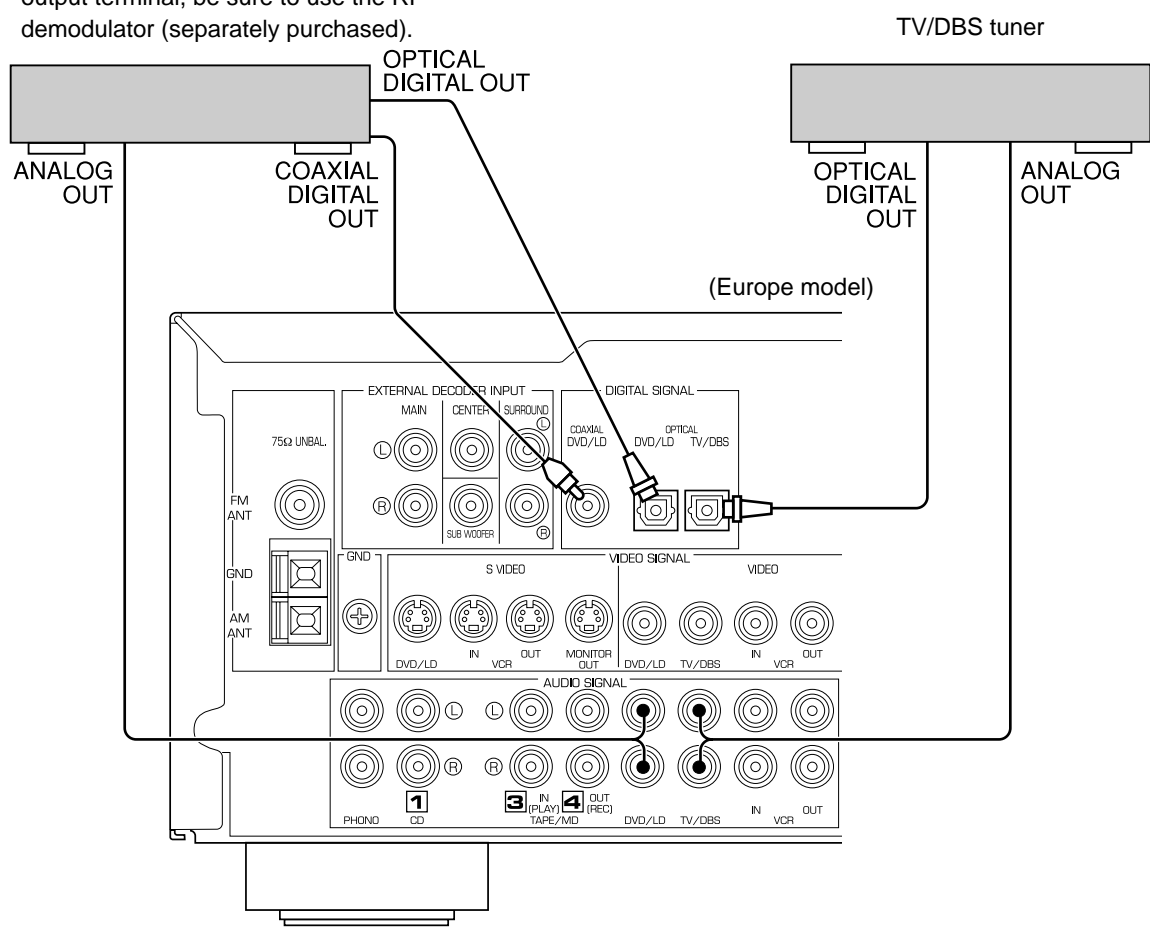

CONNECTING TO S VIDEO TERMINALS

If you have a VCR and a monitor equipped with “S” (high-resolution) video terminals, those terminals can be connected to this unit’s **S VIDEO** terminals. Connect the VCR’s “S” video input and output terminals to this unit’s **S VIDEO VCR OUT** and **IN** terminals, respectively, and connect the monitor’s “S” video input terminal to this unit’s **S VIDEO MONITOR OUT** terminal. Otherwise, connect the VCR’s composite video terminals to this unit’s composite video terminals, and connect the monitor’s composite video input terminal to this unit’s composite **MONITOR OUT** terminal.

In addition, if you have a DVD or LD player equipped with an “S” video terminal, connect the DVD/LD player’s “S” video output terminal to this unit’s **S VIDEO DVD/LD** terminal.

Note

If video signals are sent to both **S VIDEO** input and composite input terminals, the signals will be sent to their respective output terminals.

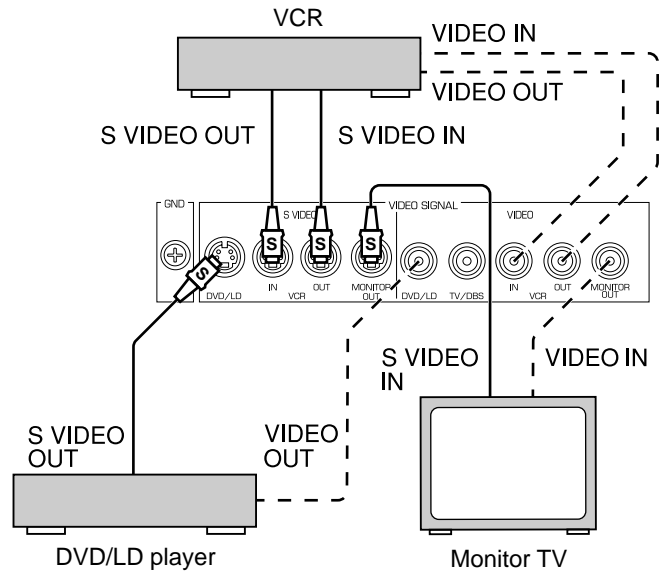

S VIDEO cable

S VIDEO terminals

This unit provides you with **S VIDEO** terminals in addition to standard VIDEO terminals.

S VIDEO terminals transmit video signals separated into luminance (Y) signals and color (C) signals. In comparison with **S VIDEO** terminals, standard VIDEO terminals transmit “composite” video signals.

CONNECTING TO VIDEO AUX TERMINALS (ON THE FRONT PANEL)

These terminals are used to connect any video input source such as a camcorder to this unit.

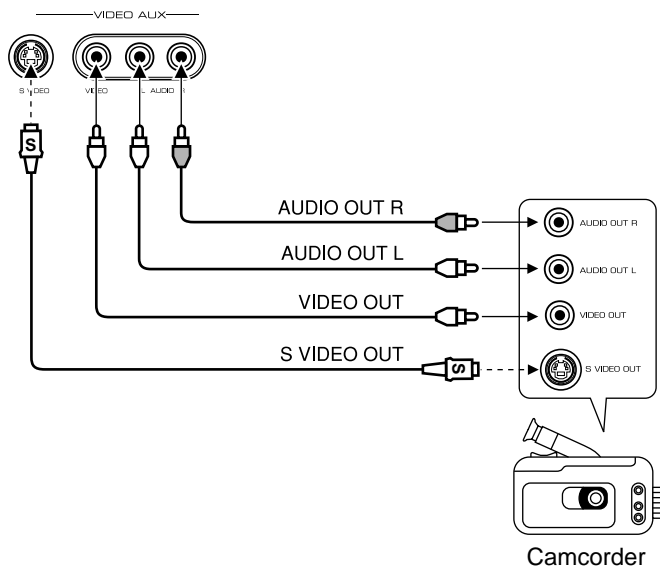

CONNECTING WITH A MONITOR TV THAT USES A 21-PIN CONNECTOR FOR INPUT

Make a connection as shown below with a commercially available SCART-plug connector cable.

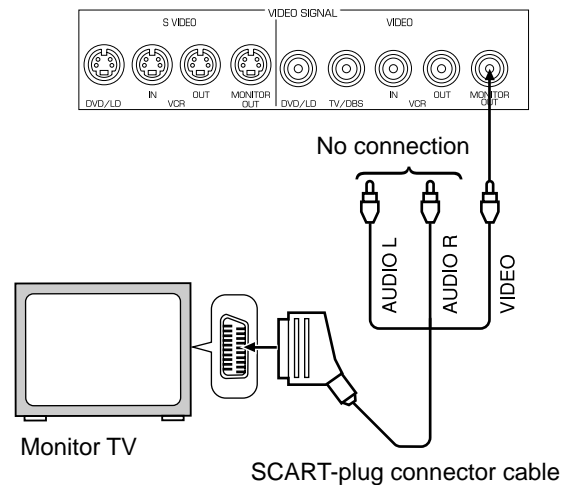

CONNECTING TO AN EXTERNAL DECODER

This unit is equipped with additional 6-channel audio signal input terminals for inputting signals from an external decoder to this unit.

Connect the 6-channel audio signal output terminals of the decoder to the **EXTERNAL DECODER INPUT** terminals of this unit.

Notes

- When signals input to these terminals are selected, the digital sound field processor cannot be used.
- The settings of “CNTR”, “REAR”, “MAIN” and “BASS” in the SET MENU mode have no effect on the signals input to these terminals. The setting of “M.LVL” is effective. (Refer to page 19 for details.)
- Adjustment of the output level of the center speakers, rear speakers and subwoofer is effective when the signals input to these terminals are selected as the input source. (Refer to page 40 for details.)

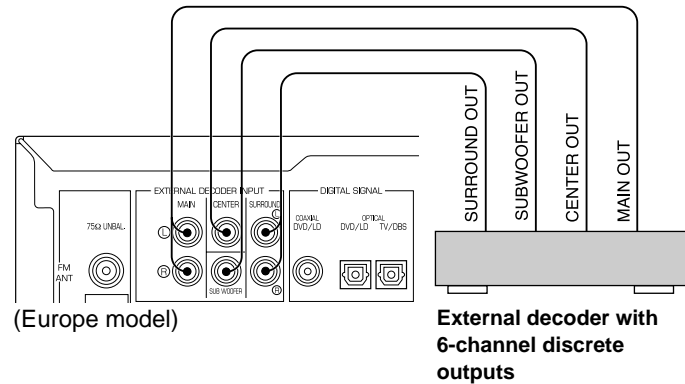

IMPEDANCE SELECTOR SWITCH

WARNING

Do not change the **IMPEDANCE SELECTOR** switch setting while the power to this unit is on, otherwise this unit may be damaged.

If this unit fails to turn on when the STANDBY/ON switch is pressed, the **IMPEDANCE SELECTOR** switch may not be fully set to either end. If so, set the switch to either end fully when this unit is in the standby mode.

Select the position whose requirements your speaker system meets.

 (Upper position)

Main: If you use one pair of main speakers, the impedance of each speaker must be 4 Ω or higher.

If you use two pairs of main speakers, the impedance of each speaker must be 8 Ω or higher.

Center: The impedance of the speaker must be 6 Ω or higher.

Rear: The impedance of each speaker must be 6 Ω or higher.

 (Lower position)

Main: If you use one pair of main speakers, the impedance of each speaker must be 8 Ω or higher.

If you use two pairs of main speakers, the impedance of each speaker must be 16 Ω or higher.

Center: The impedance of the speaker must be 8 Ω or higher.

Rear: The impedance of each speaker must be 8 Ω or higher.

IMPEDANCE SELECTOR

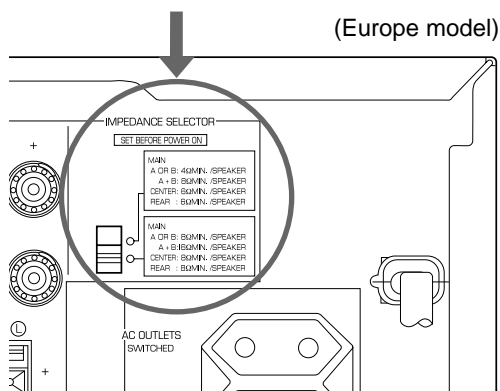

CONNECTING SPEAKERS

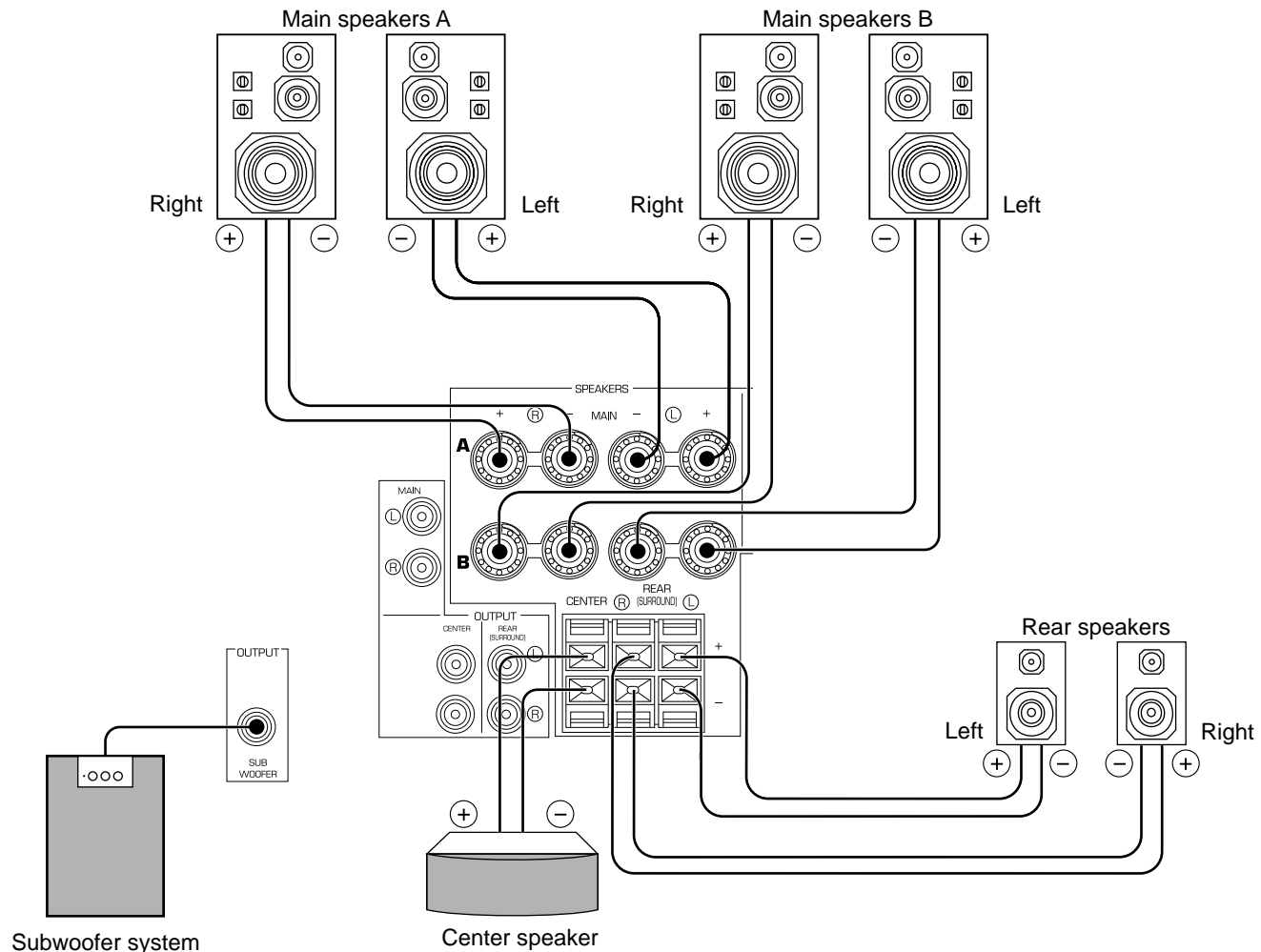

Note
Use speakers with the specified impedance shown on the rear panel of this unit.

Main speaker connections

One or two speaker systems can be connected to this unit. If you use only one speaker system, connect it to either of the **SPEAKERS A** or **B** terminals.

Rear speaker connections

A rear speaker system can be connected to this unit. Place them to the rear of your listening position.

Center speaker connection

A center speaker can be connected to this unit. Place it on or under the TV.

Subwoofer connection

You may wish to add a subwoofer to reinforce low frequencies or to output low bass sound from the subwoofer channel. If you have a subwoofer with built-in amplifier, including the YAMAHA Active Servo Processing Subwoofer System, connect the **SUBWOOFER OUTPUT** terminal of this unit to the input terminal of the subwoofer system.

How to connect

Connect the **SPEAKERS** terminals to your speakers with wire of the proper gauge, cut as short as possible. If the connections are faulty, no sound will be heard from the speakers. Make sure that the polarity of the speaker wires is correct, that is the + and – markings are observed. If these wires are reversed, the sound will be unnatural and lack bass.

Caution

Do not let the bare speaker wires touch each other and do not let them touch any metal part of this unit. This could damage the unit and/or speakers.

Connecting to the MAIN SPEAKERS terminals

Red: positive (+)
Black: negative (–)

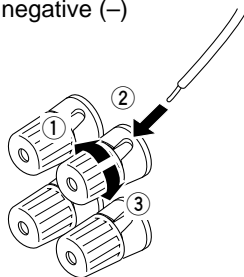

- ① Unscrew the knob.
- ② Remove approx. 5 mm (1/4") of insulation from each of the speaker wires and insert one bare wire into each terminal.
- ③ Tighten the knob to secure the wire.

Connecting to the REAR and CENTER SPEAKERS terminals

Red: positive (+)
Black: negative (–)

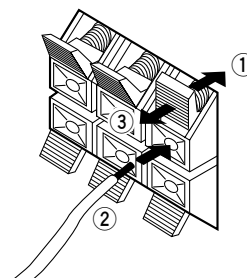

- ① Press the tab.
- ② Remove approx. 5 mm (1/4") of insulation from each of the speaker wires and insert one bare wire into each terminal.
- ③ Release the tab to secure the wire.

OUTPUT TERMINALS (FOR DRIVING A SPEAKER WITH AN EXTERNAL AMPLIFIER)

The speaker connections described on page 16 are fine for most applications. If for some reason, however, you wish to drive main, center and/or rear speakers with your existing amplifier, etc., the following terminals are available for connecting an external amplifier(s) to this unit.

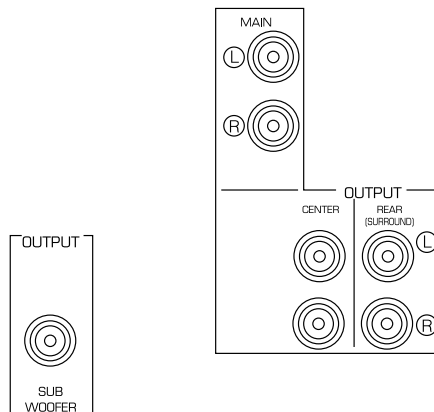

ANTENNA CONNECTIONS

Each antenna should be correctly connected to the designated terminals, referring to the following diagram. Both AM and FM indoor antennas are included with this unit. In general, these antennas will probably provide sufficient signal strength. Nevertheless, a properly installed outdoor antenna will give clearer reception than an indoor one. If you experience poor reception quality, an outdoor antenna may result in improvement.

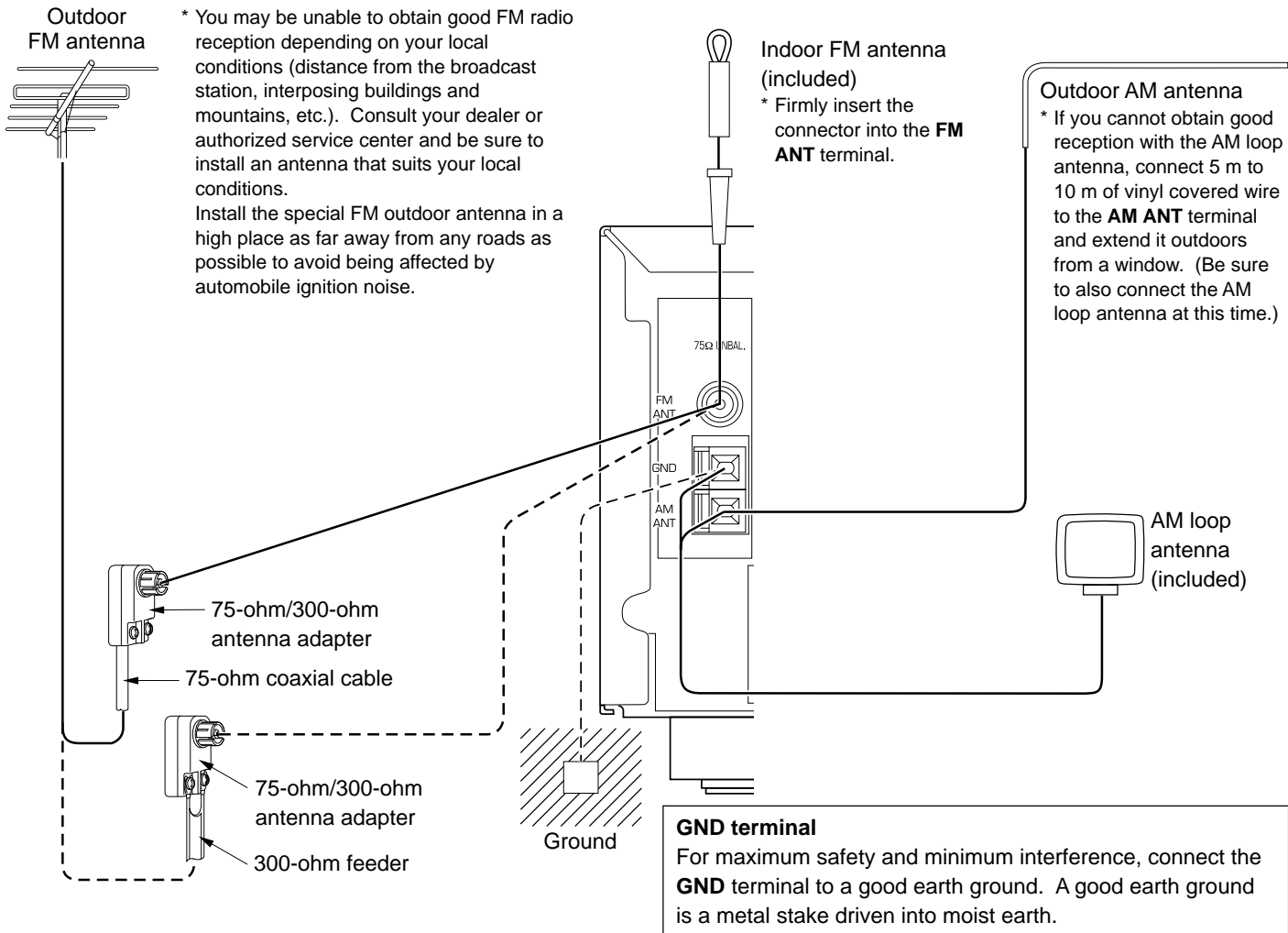

Connecting the AM loop antenna

- 1**
 - ① Press the tab and unlock the terminal hole.
 - ② Connect the AM loop antenna lead wires to the **AM ANT** and **GND** terminals.
 - ③ Return the tab to its original position to lock the lead wires. Lightly pull the lead wires to confirm a good connection.
- 2** Attach the loop antenna to the antenna stand.
- 3** Orient the AM loop antenna so that the best reception is obtained.

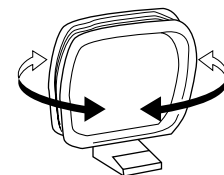
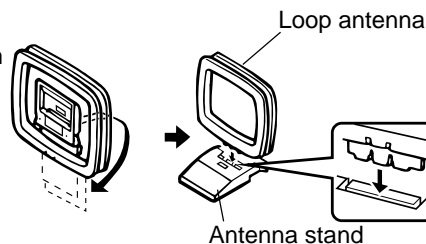
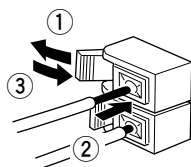

- The AM loop antenna should be placed away from this unit. The antenna may be hung on a wall.
- The AM loop antenna should always be connected, even if an outdoor AM antenna is connected to this unit.

ADJUSTMENTS BEFORE USING THIS UNIT

SELECTING THE OUTPUT MODES

This unit provides you with the following five functions to determine the method of distributing output signals to speakers suitable for your audio system. When speaker connections have all been completed, select the proper setting for each function to make the best use of your speaker system. (See "ADJUSTMENTS IN THE 'SET MENU' MODE" on page 42.)

1. **CNTR (CENTER SPEAKER)** 2. **REAR (REAR SPEAKERS)** 3. **MAIN (MAIN SPEAKERS)**
4. **BASS (LFE/BASS OUT)** 5. **M.LVL (MAIN LEVEL)**

DESCRIPTION OF EACH FUNCTION

CNTR (CENTER SPEAKER)

Choices: LARGE/SMALL/NONE

Preset position: LARGE

LARGE: Select this position when your center speaker is approximately the same size as the main speakers.

SMALL: Select this position when you use a center speaker that is smaller than the main speakers.
In this position, low bass signals (below 90 Hz) on the center channel are output from the main speakers (or the **SUBWOOFER OUTPUT** terminal if the SMALL position is selected for "MAIN" and the SW position is selected for "BASS").

NONE: Select this position when you do not have a center speaker (four speaker system). The center channel sound will be output from the left and right main speakers.

REAR (REAR SPEAKERS)

Choices: LARGE/SMALL

Preset position: LARGE

LARGE: Select this position if your rear speakers have high ability for bass reproduction, or if a subwoofer is connected in parallel to the rear speaker.
In this position, full-range signals are output from the rear speakers.

SMALL: Select this position if your rear speakers do not have high ability for bass reproduction.
In this position, low bass signals (below 90 Hz) on the rear channels are output from the **SUBWOOFER OUTPUT** terminal (or the main speakers if the MAIN position is selected for "BASS").

MAIN (MAIN SPEAKERS)

Choices: LARGE/SMALL

Preset position: LARGE

LARGE: Select this position if your main speakers have high ability for bass reproduction.

In this position, full-range signals present on the main channels are output from the main speakers.

SMALL: Select this position if your main speakers do not have high ability for bass reproduction. However, if your system does not include a subwoofer, do not select this position.

In this position, low bass signals (below 90 Hz) on the main channels are output from the **SUBWOOFER OUTPUT** terminal if the SW or BOTH position is selected for "BASS".

BASS (LFE/BASS OUT)

Choices: SW/MAIN/BOTH

Preset position: SW

MAIN: Select this position if your system does not include a subwoofer.

In this position, full-range signals present on the main channels, signals from the LFE channel and other low bass signals that are distributed from other channels are output from the main speakers.

SW/BOTH:

Select either the SW or BOTH position if your system includes a subwoofer.

In either position, signals on the LFE channel and other low bass signals that are distributed from other channels are output from the **SUBWOOFER OUTPUT** terminal.

When the LARGE position is selected for "MAIN", in the SW position, no signal is distributed from the main channels to the **SUBWOOFER OUTPUT** terminal; however, in the BOTH position, low bass signals from the main channels are output to both the main speakers and the **SUBWOOFER OUTPUT** terminal.

M.LVL (MAIN LEVEL)

Choices: NRML (NORMAL)/-10 dB

Preset position: NRML (NORMAL)

NRML (NORMAL):

Normally select this position.

-10 dB: Select this position if the sound output from the main speakers is too loud and cannot be balanced with the sound output from the center and rear speakers. In this position, the sound output from the main speakers is attenuated.

Note

The settings of "CNTR", "REAR", "MAIN" and "BASS" have no effect on the signals input to the **EXTERNAL DECODER INPUT** terminals on the rear of this unit.

ADJUSTMENT METHOD

Adjustments should be made while watching the information on this unit's display.

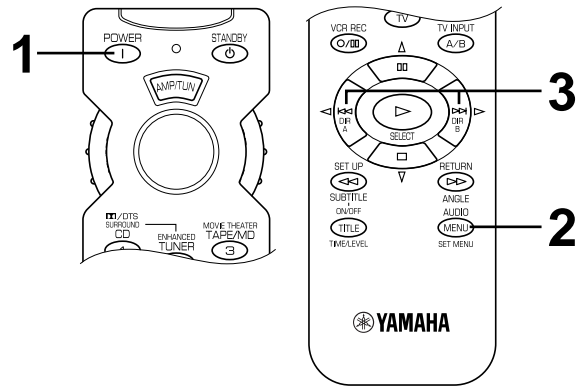
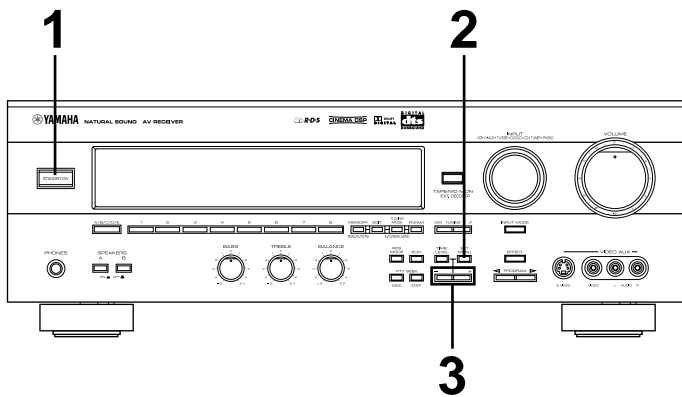

When adjusting with the remote control, set the **SELECTOR DIAL** to the AMP/TUN or DSP position on the remote control.

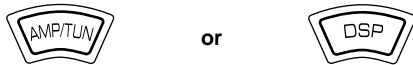

1 Turn the power on.

Front panel

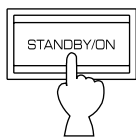

Remote control

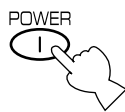

2 Press **SET MENU** once or more to select the function "CNTR" on the display.

Front panel

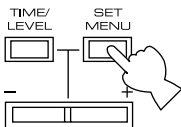

Remote control



* After pressing **SET MENU** once on the remote control, you can also select the function by pressing ∇ . (Pressing Δ goes back one selection.)

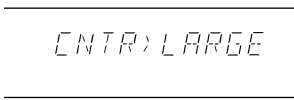

3 Press **+** or **-** once or more to select the setting you want.

Front panel

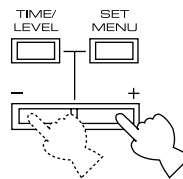

Remote control

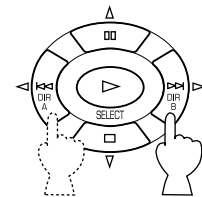

CNTR > SMALL

4 Repeat steps 2 and 3 to change the settings for "REAR", "MAIN", "BASS" and/or "M.LVL" in the same way.

SPEAKER BALANCE ADJUSTMENT

This procedure lets you adjust the sound output level balance between the main, center and rear speakers by using the built-in test tone generator. When this adjustment is performed, the sound output level heard at the listening position will be the same from each speaker. This is important for the best performance of the digital sound field processor, the Dolby Digital decoder, the Dolby Pro Logic decoder and the DTS decoder.

The adjustment of each speaker output level should be done at your listening position with the remote control. After completing the adjustment of the output level for each speaker, use VOLUME (^ v) on the remote control at your listening position to check if the adjustments are satisfactory.

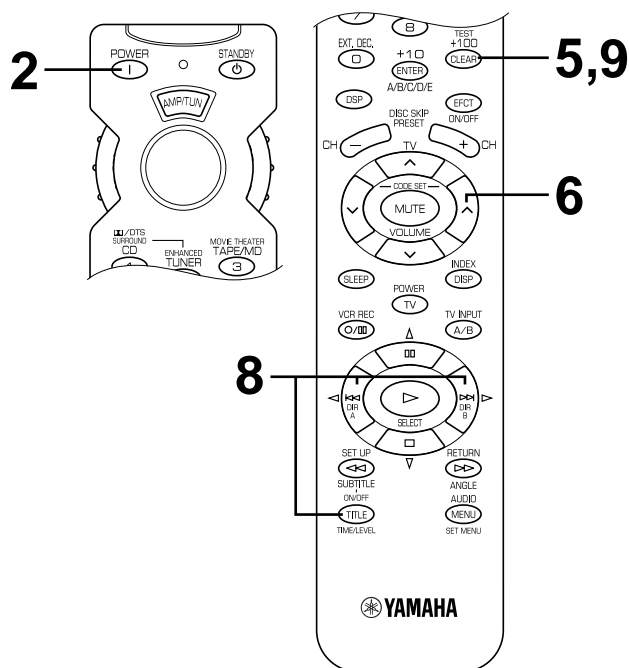
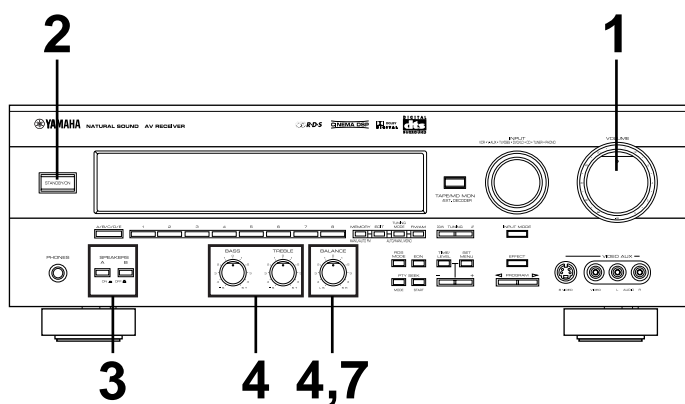

Set the SELECTOR DIAL to the AMP/TUN or DSP position on the remote control.

2 Turn the power on.

Front panel:

Remote control:

1 Set VOLUME to the “∞” position.

Front panel

3 Select the main speakers to be used.

Front panel

* If you use two main speaker systems, press both **A** and **B**.

4 Set **BASS**, **TREBLE** and **BALANCE** to the "0" position.

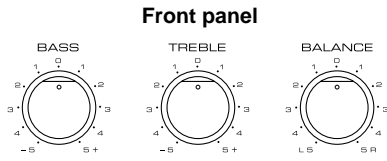

5 Press **TEST** so that "TEST LEFT" appears on the display.

Remote control

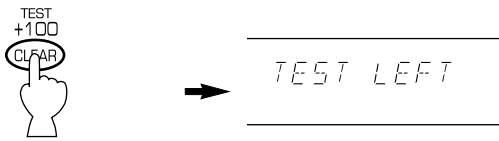

6 Turn up the volume.

Remote control

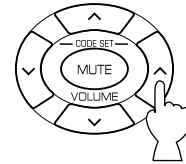

You will hear a test tone (like pink noise) from each speaker for about two seconds in following order: left main speaker, center speaker, right main speaker, right rear speaker and left rear speaker. The display changes as shown below.

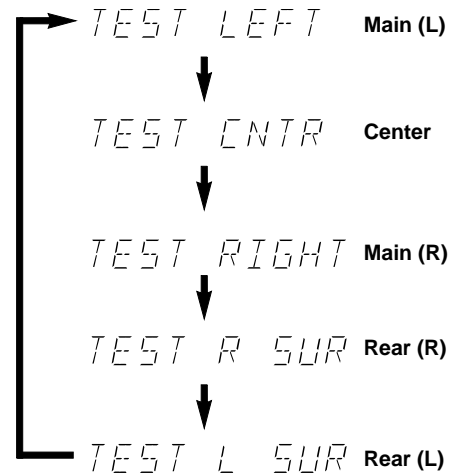

* If the function "CNTR" in the SET MENU mode is set to the NONE position, you will hear the center channel test tone from the left and right main speakers.

7 Adjust **BALANCE** so that the sound output level of the left main speaker and the right main speaker is the same.

Front panel



8 Adjust the sound output levels of the center speaker and the rear speakers so that they become almost the same as that of the main speakers.

Press **TIME/LEVEL** once or more to select the speaker to be adjusted so that "CENTER", "R SUR." or "L SUR." appears on the display.

Remote control



* You cannot adjust the delay time while the test tone is sounding even if "DELAY" appears on the display after pressing **TIME/LEVEL** once or more.

Adjust the level.

- * Pressing > raises and < lowers the level.
- * While adjusting, the test tone is heard from the selected speaker.

Remote control

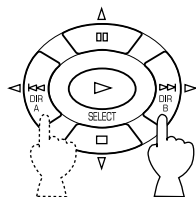

9 When the adjustment is finished, press **TEST** again to stop the test tone.

Remote control

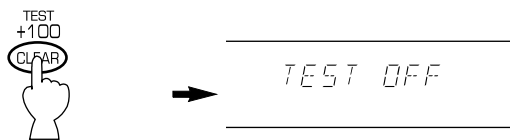

Notes

- Once you have completed these adjustments, you can only adjust the overall sound level of your audio system by using **VOLUME** (or **VOLUME** (^ v) on the remote control).
- If you use external power amplifiers, you may also use their volume controls to achieve the proper balance.
- If the function "CNTR" in the SET MENU mode is set to the NONE position, the sound output level of the center speaker cannot be adjusted in step 8. The center sound is automatically output from the left and right main speakers.
- If there is insufficient sound output from the center and rear speakers, you may decrease the main speaker output level by setting "M.LVL" to "-10 dB".

BASIC OPERATION

TO PLAY A SOURCE

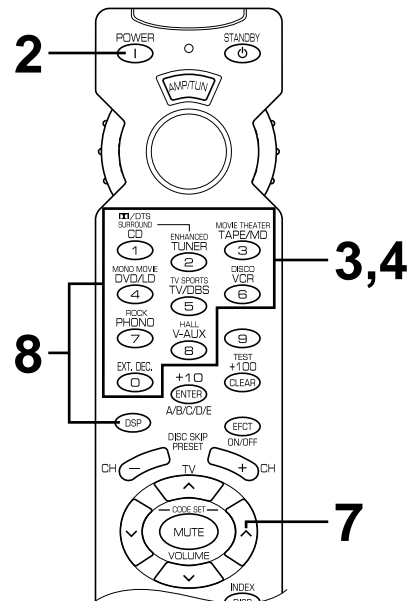
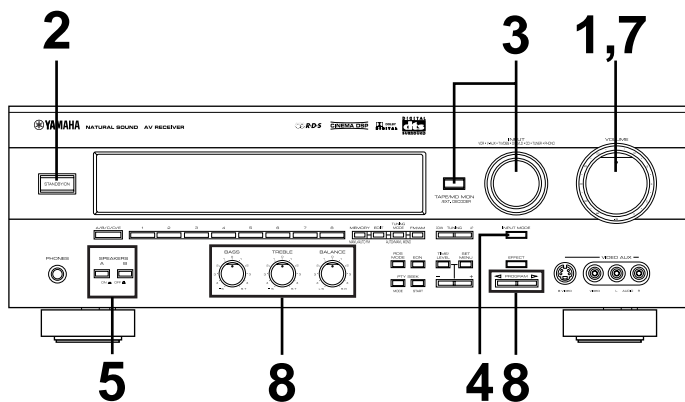

When using the remote control

- Set the SELECTOR DIAL to the AMP/TUN position on the remote control.
- To operate the CD player, DVD/LD player, tape deck, MD recorder, or other components with this remote control, set the SELECTOR DIAL to the component to be used. (See "SETUP CODES" on page 50.)

1 Set **VOLUME** to the "∞" position.

Front panel

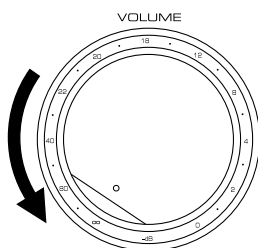

2 Turn the power on.

Front panel

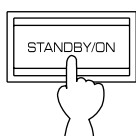

Remote control



3 Select the desired input source by using **INPUT**.
(Turn on the monitor TV for video sources.)

Front panel

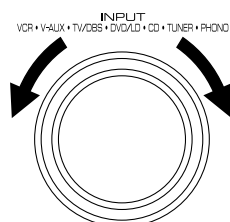

Remote control

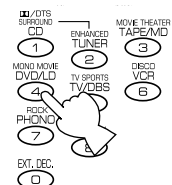

or

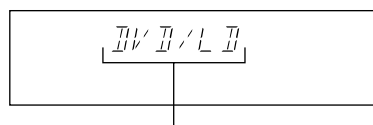

The name of the selected input source will appear on the display.

To play a tape or an MD

Press **TAPE/MD MON / EXT. DECODER** on the front panel or **TAPE/MD** on the remote control so that the "TAPE/MD MON" indicator lights up on the display.

Front panel

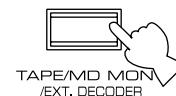

To use a decoder connected to the EXTERNAL DECODER INPUT terminals

Press **TAPE/MD MON / EXT. DECODER** once or more on the front panel or **EXT. DEC.** on the remote control so that "EXT. DECDR" appears on the display.

- 4** For a DVD/LD or TV/DBS source, the current input mode is also shown.
- * To change the input mode for the DVD/LD or TV/DBS source, press **INPUT MODE** (or the button that you have pressed to select the input source in step 3 on the remote control) once or more until the desired input mode is shown on the display. (See page 26 for details on switching the input mode.)

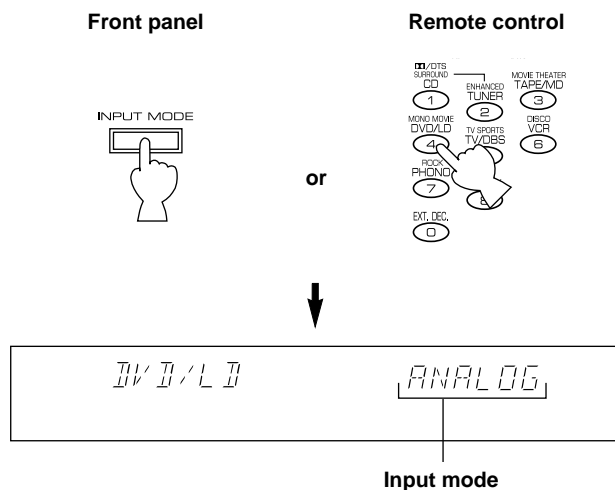

- 5** Select the main speakers to be used.

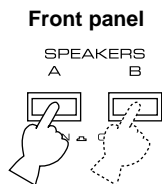

* If you use two main speaker systems, press both **A** and **B**.

- 6** Play the source. (See page 28 for detailed information on tuning.)

- 7** Adjust the volume to the desired output level.

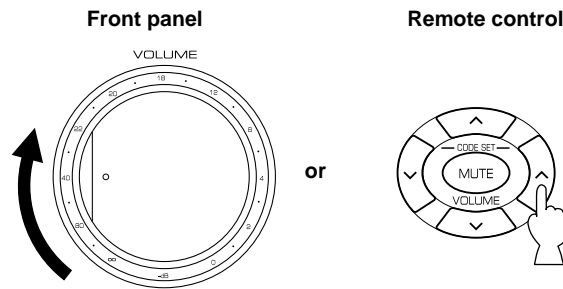

- 8** If desired, adjust **BASS**, **TREBLE**, **BALANCE**, etc. and use the digital sound field processor (see pages 37 to 38).

BASS: Turn this control clockwise to increase (or counterclockwise to decrease) the low-frequency response.

TREBLE: Turn this control clockwise to increase (or counterclockwise to decrease) the high-frequency response.

BALANCE: Adjust the balance of the output volume from the left and right speakers to compensate for any sound imbalance caused by the speaker location or listening room conditions.

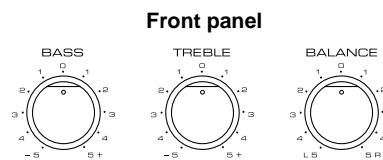

* These controls are only effective for the sound from the main speakers.

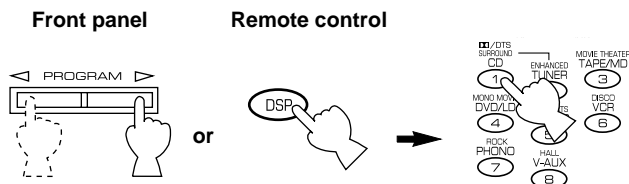

When you have finished using this unit

Press **STANDBY/ON** on the front panel again or **STANDBY** on the remote control to set this unit in the standby mode.

Notes on using INPUT

- The audio source selected by **INPUT** will not be played if the "TAPE/MD MON" indicator lights up or if "EXT. DECDR" is displayed.
- If you select a video source by **INPUT** without canceling the selection of **TAPE/MD MON / EXT. DECODER** on the front panel (or **TAPE/MD** or **EXT. DEC.** on the remote control), the play back result will be a video image from the video source and the sound from the audio source selected by **TAPE/MD MON / EXT. DECODER** on the front panel (or **TAPE/MD** or **EXT. DEC.** on the remote control).
- If an audio source is selected by **INPUT** while watching a video source, the selected audio source will be played, but the video image will not be interrupted.
- When you select an input source by **INPUT**, the DSP program (or no DSP program) that was being used when the same input source was selected the last time will be automatically recalled.
- If "DATA ERR" appears on the display while playing a CD or LD encoded with DTS, stop playback and turn the player off and then on again.

Switching the input mode (for DVD/LD and TV/DBS)

This unit allows you to switch the input mode for sources that send two or more types of signal to this unit. The following three input modes are provided.

AUTO

This mode is automatically selected when you turn on the power of this unit.

In this mode, the input signal is automatically selected in the following order of priority:

1. Digital signal encoded with Dolby Digital or DTS, or normal digital input signal (PCM)
2. Analog input signal (ANALOG)

* For a DVD/LD source, if digital signals are input from both the **OPTICAL** and **COAXIAL** terminals, the digital signal from the **COAXIAL** terminal is selected.

DTS

In this mode, only a digital input signal encoded with DTS is selected, even though other signals are input at the same time.

ANALOG

In this mode, only an analog input signal is selected, even though digital signals are input at the same time.

Select this mode when you want to use an analog input signal instead of digital input signals.

Notes on input mode selection

- The input mode for a TV/DBS source is selected with the function "INPUT" in the SET MENU mode. (See page 43 for details.)
- Set the input mode to AUTO to play a DVD/LD source encoded with Dolby Digital.
- Set the input mode to ANALOG to play a normal 2-channel source with a Dolby Surround program.
- The sound output may be interrupted in some LD and DVD players in the following situation:
The input mode is set to AUTO. A search is made while playing the disc encoded with Dolby Digital or DTS, and then disc playing is restored. The sound output is interrupted for a moment because the digital input signal was selected again.
- The input mode cannot be changed for the PHONO, TUNER, TAPE/MD, CD, VCR and VIDEO AUX sources because only analog signals are used.
- The present input mode appears on the display when the input source is changed to DVD/LD or TV/DBS, or the input mode is changed.

Notes on playing a source encoded with DTS

If you play a CD or LD encoded with DTS while the AUTO mode is selected, there will be a short noise at first while the unit identifies the DTS signal and activates the DTS decoder. This is not a malfunction, and can be avoided by setting the input mode to DTS beforehand. In addition, if you continue to play a CD or LD encoded with DTS with the input mode setting left at AUTO, this unit automatically switches to the "DTS-decoding" mode to prevent noise from being generated during future operation. (The red "dts" indicator lights up on the display.)

No sound will be heard if a normal PCM CD or LD is played in this mode. (The red "dts" indicator will flash.) To play a normal disk, return the input mode from DTS to AUTO.

TO RECORD A SOURCE ON TAPE, MD OR VIDEO CASSETTE

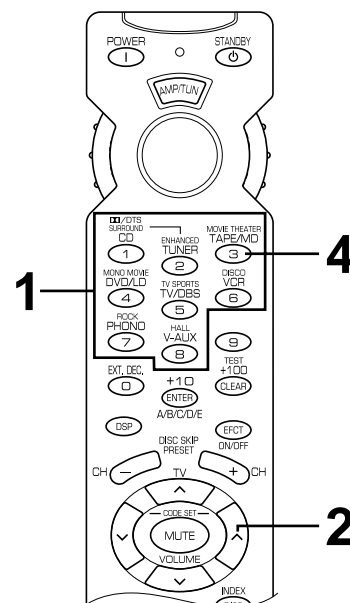
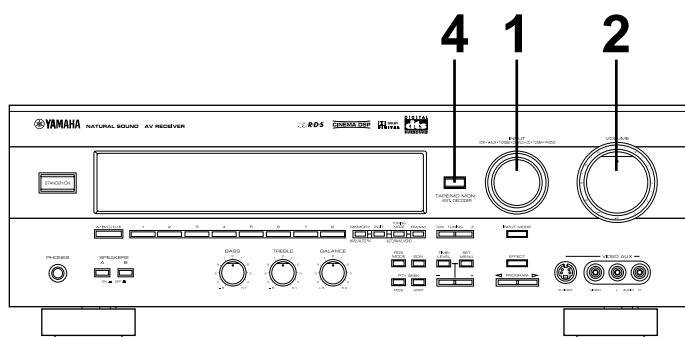

1 Select the source to be recorded.

Front panel **Remote control**

INPUT
VCR • V-AUX • TV/OBS • DVD/LD • CD • TUNER • PHONO

or

1 2 3 4 5 6 7

2 Play the source and then turn up the volume to confirm the input source. (See page 28 for detailed information on tuning.)

Front panel **Remote control**

VOLUME

or

MUTE

3 Begin recording on the tape deck, MD recorder or VCR connected to this unit.

4 When a tape deck or MD recorder is being used for recording, you can monitor the sounds being recorded by pressing **TAPE/MD MON / EXT. DECODER** on the front panel or **TAPE/MD** on the remote control so that the "TAPE/MD MON" indicator lights up on the display.

Front panel **Remote control**

TAPE/MD MON / EXT. DECODER or MOVIE THEATER TAPE/MD

→ TAPE/MD MON

Notes

- The settings of DSP and **VOLUME, BASS, TREBLE** and **BALANCE** have no effect on the material being recorded.
- Composite video and S video signals pass independently through this unit's video circuits. Therefore, when recording or dubbing video signals, if your video source unit is connected to provide only an S video (or only a composite video) signal, you can record only an S video (or only a composite video) signal on your VCR.
- A source that is connected to this unit only through the digital terminals cannot be recorded on a tape deck, MD recorder or VCR connected to this unit.
- A source of signals input to the **EXTERNAL DECODER INPUT** terminals of this unit cannot be recorded.
- Please check the copyright laws in your country to record from records, compact discs, radio, etc. Recording of copyright material may infringe copyright laws.

If you watch video software that uses scrambled or encoded signals to prevent it from being dubbed, there may be a case that the picture itself will be affected by those signals.

TUNING

Quick automatic-search tuning (AUTOMATIC TUNING) is effective when station signals are strong and there is no interference. However, if the signal from the station you want to select is weak, you must tune in to it manually (MANUAL TUNING).

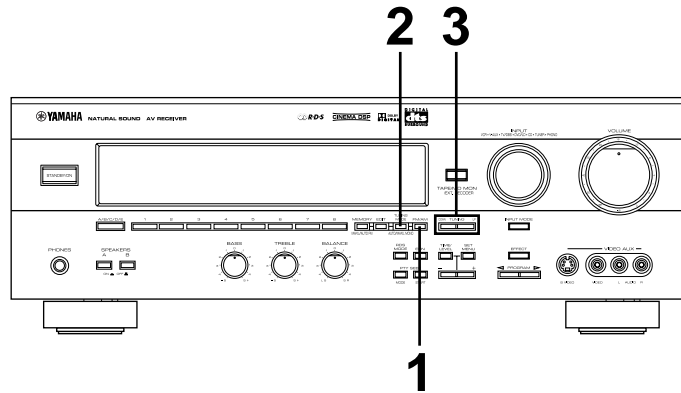

AUTOMATIC TUNING

MANUAL TUNING

Set the SELECTOR DIAL to the AMP/TUN position on the remote control and select TUNER as the input source.

- 1 Select the reception band (FM or AM) and confirm it on the display.

Front panel

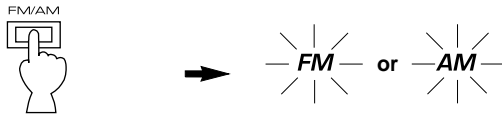

- 2 Press **TUNING MODE** so that the "AUTO TUNING" indicator lights up on the display.

Front panel

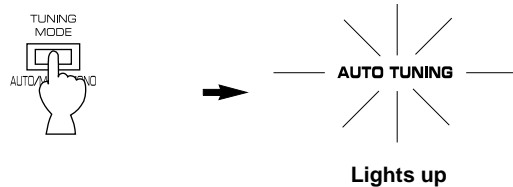

- 3 To tune in to a higher frequency, press the UP side of **TUNING** once.
To tune in to a lower frequency, press the DOWN side of **TUNING** once.

Front panel

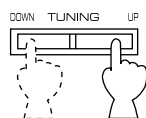

- * If the station where the tuning search stops is not the desired one, press once more.
- * If the tuning search does not stop at the desired station (because the signal from the station is weak), take the manual tuning procedure.

- 1 Select the reception band (FM or AM) and confirm it on the display.

Front panel

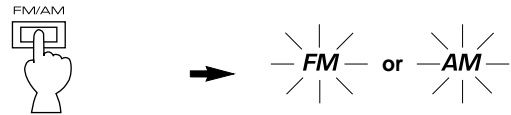

- 2 Press **TUNING MODE**.

Front panel

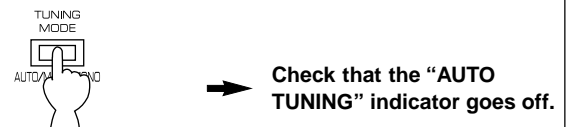

- 3 Tune in manually to the desired station.

Front panel

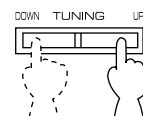

- * To continue the tuning search, press and hold the button.

Notes

- If you tune in manually to an FM station, it will be automatically received in monaural mode to increase the signal quality.
- When tuned in to a station, the frequency of the received station is shown on the display. If an RDS station that employs the PS data service is being received, the station name is also shown on the display.

MANUAL PRESET TUNING

This unit can store station frequencies to be selected by tuning. With this function, you can recall any desired station simply by selecting the preset station number with which it was stored. Up to 40 stations (8 stations x 5 groups) can be stored.

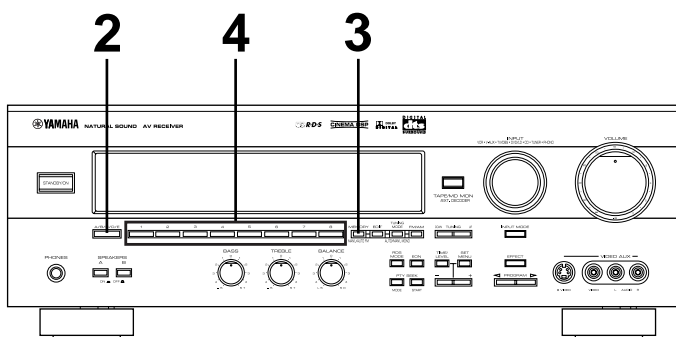

To store stations

1 Tune in to the desired station.
(See page 28 for the tuning procedure.)

2 Press **A/B/C/D/E** once or more to select the desired group (A to E) of preset stations and confirm it on the display.

Front panel

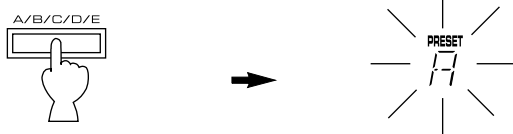

3 Press **MEMORY** so that the “MEMORY” indicator flashes for about five seconds.

Front panel

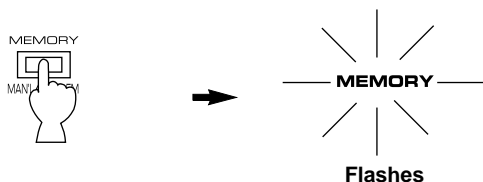

4 Select the preset station number with which you want to store the station before the “MEMORY” indicator goes off from the display.

Front panel

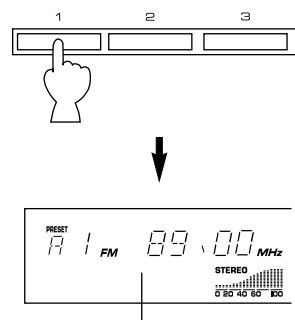

The displayed station has been stored as A1.

- * In the same way, store other stations as A2, A3 ... A8.
- * You can store more stations as preset station numbers in other groups in the same way by selecting another group in step 2.

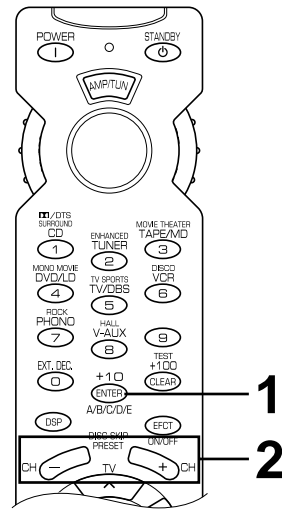
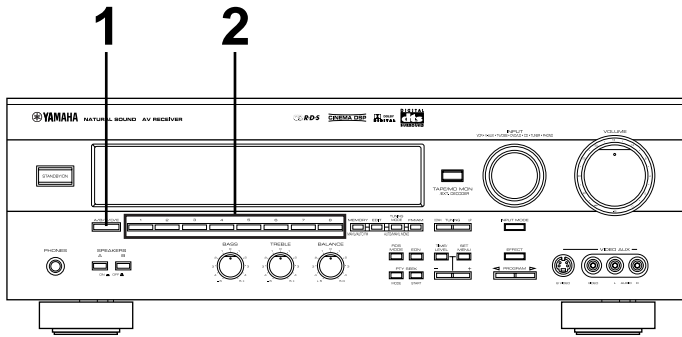

To recall a preset station

- 1 Select the group of preset stations.

Front panel

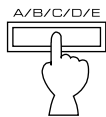

Remote control

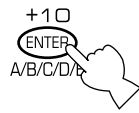

or

- 2 Select the preset station number.

Front panel

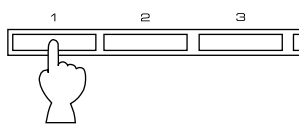

Remote control



Notes

- A new setting can be stored in place of the former one.
- For presets, the setting of the reception mode (stereo or monaural) is stored along with the station frequency.

Memory back-up

The memory back-up circuit prevents the stored data from being lost when this unit is set in the standby mode. If, however, the power plug is disconnected from the AC outlet or the power is cut due to temporary power failure for more than one week, the memory will be erased. If so, it can be re-stored by simply following the preset tuning procedure.

AUTOMATIC PRESET TUNING (for RDS stations only)

You can also make use of the automatic preset tuning function for RDS stations only. This function enables the unit to perform automatic tuning and to sequentially store RDS stations with strong signals. Up to 40 stations can be stored automatically in the same way as that for manual preset tuning on page 29. Note that a new setting can be stored in place of the former one.

* See pages 33 to 35 for details on RDS stations.

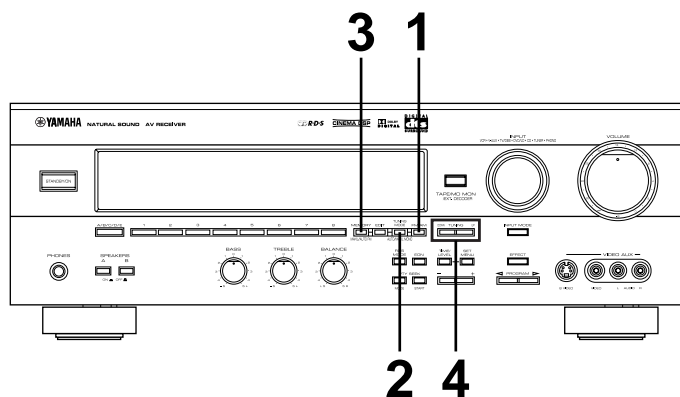

To store stations

- 1** Select the FM band.

Front panel

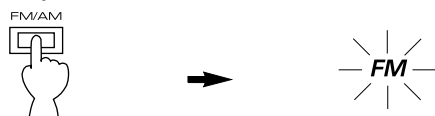

- 2** Press **TUNING MODE** so that the “AUTO TUNING” indicator lights up on the display.

Front panel

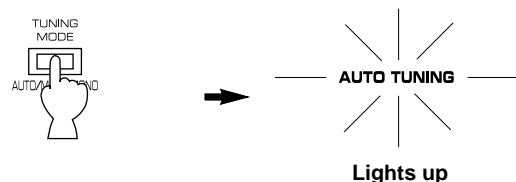

- 3** Press **MEMORY** and hold for about three seconds.

Front panel

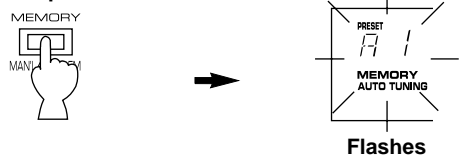

- 4** To tune in to higher frequencies, press the UP side of **TUNING** once.
To tune in to lower frequencies, press the DOWN side of **TUNING** once.

Front panel

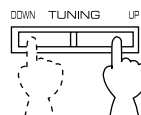

* If **TUNING** is not pressed, automatic preset tuning soon begins automatically toward the higher frequencies.

Automatic preset tuning begins from the frequency currently displayed. Received stations are sequentially stored as A1, A2 ... A8.

* If more than 8 stations are received, they are stored as preset station numbers in other groups (B, C, D and E) in that order.

If you want to store the first station received by automatic preset tuning as a desired preset station number

For example, if you want to store the first received station as C5, select “C5” while “A1”, the “MEMORY” indicator and the “AUTO TUNING” indicator flash after pressing **MEMORY** in step 3. Then press **TUNING**. The first received station is stored as C5, and the next stations as sequentially C6, C7 ...

If stations have all been stored up to E8, automatic preset tuning stops automatically.

When automatic preset tuning is completed

The display shows the frequency of the last preset station. Check the contents and the number of preset stations by following the procedure in the section “To recall a preset station” on page 30.

Notes

- You can manually replace a preset station with another FM or AM station by simply following the procedure in the section “To store stations” on page 29.
- An automatic preset tuning search will be performed through all RDS network frequencies until stations have been stored up to E8. Even if the number of received stations is not enough to be stored up to E8, the search is automatically ended after searching all frequencies.
- With this function, only RDS stations with sufficient signal strength are automatically stored. If the station you want to store is weak in signal strength, tune in to it manually in monaural sound and store it by following the procedure in the section “To store stations” on page 29.
- * There may be a case that this function cannot receive a station which could be received by the automatic tuning method. This is because this function receives a large volume of PI (Program Identification) data along with the station.

EXCHANGING PRESET STATIONS

You can exchange the assignment of two preset stations with each other as shown below.

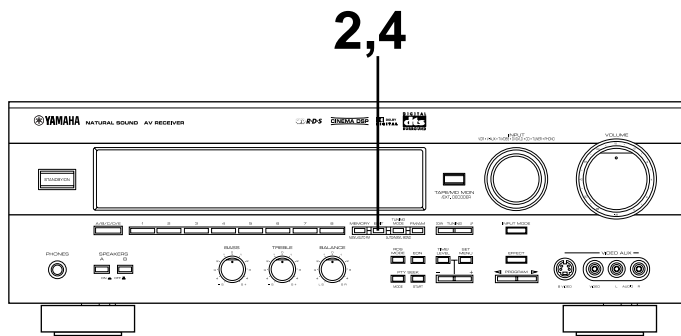

Example

If you want to change the preset station from “E1” to “A5”, or vice versa.

1 Recall preset station “E1” by following the procedure in the section “To recall a preset station” on page 30.

2 Press **EDIT**.

Front Panel

Flashes

3 Next, recall preset station “A5” by following the same procedure as that in step 1.

Flashes

4 Press **EDIT** once more.

Front Panel

Shows the exchange of stations has been completed.

RECEIVING RDS STATIONS

Radio Data System (RDS) is a data transmission system gradually being introduced by FM stations in many countries. Stations using this system transmit an inaudible stream of data in addition to the normal radio signal.

RDS data contains various information such as PI (Program Identification), PS (Program Service name), PTY (Program Type), RT (Radio Text), CT (Clock Time), EON (Enhanced Other Networks), etc.

The RDS function is used by network stations.

DESCRIPTION OF RDS DATA

This unit can receive PI, PS, PTY, RT, CT, and EON data when receiving RDS broadcast stations.

PS (Program Service name) mode:

The name of the RDS station being received is displayed.

PTY (Program Type) mode:

The type of program on the RDS station being received is displayed. There are 15 program types to classify RDS stations. You can make this unit search for a station which is broadcasting a program of the desired type. See page 34 for details.

RT (Radio Text) mode:

Information about the program (such as the title of a song, name of the singer, etc.) on the RDS station being received is displayed by a maximum of 64 alphanumeric characters, including the umlaut sign. If other characters are used for RT data, they are displayed with under-bars.

CT (Clock Time) mode:

The current time is displayed and updated every minute. If the data is accidentally cut off, "CT WAIT" may appear.

EON (Enhanced Other Networks):

See page 35.

CHANGING THE RDS MODE

When an RDS station is being received, PS, PTY, RT and/or CT that correspond to the RDS data services employed by the station light up on the display. By pressing **RDS MODE**, you can change the display mode among the RDS modes employed by the received station in the order shown below. Illumination of the RDS modes indicator shows that the corresponding RDS mode has been selected.

- * When an RDS station is being received, do not press **RDS MODE** until one or more names of RDS modes light up on the display. If the button is pressed before one or more names light up on the display, the mode cannot be changed. This is because the unit has not yet received all of the RDS data on the station.
- * If no RDS mode lights up on the display, the mode cannot be changed.
- * An RDS mode not employed by the station cannot be selected.

Front panel

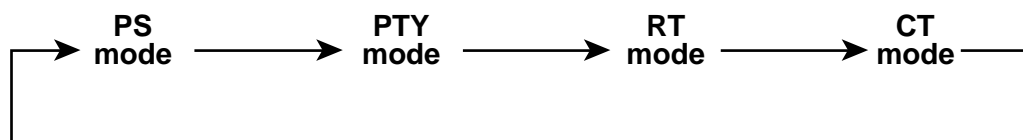

Notes

- The RDS data service cannot be utilized by this unit if the received signal is not strong enough. In particular, the RT mode requires a large amount of data to be received, so it is possible that the RT mode cannot be displayed even if other RDS modes (PS, PTY, etc.) are displayed.
- There may be a case that RDS data reception is not possible due to poor reception conditions. If so, press **TUNING MODE** so that the "AUTO TUNING" indicator goes off from the display. Although the reception mode is changed to monaural by this operation, when you change the display to RDS mode, RDS data may be displayed.
- If the signal strength is weakened by external interference during the reception of an RDS station, the RDS data service may be cut off suddenly and "...WAIT" will appear on the display.

PTY SEEK

By designating a program type, the unit automatically searches all preset RDS stations that are broadcasting a program of that type.

* There are 15 program types to classify RDS stations.

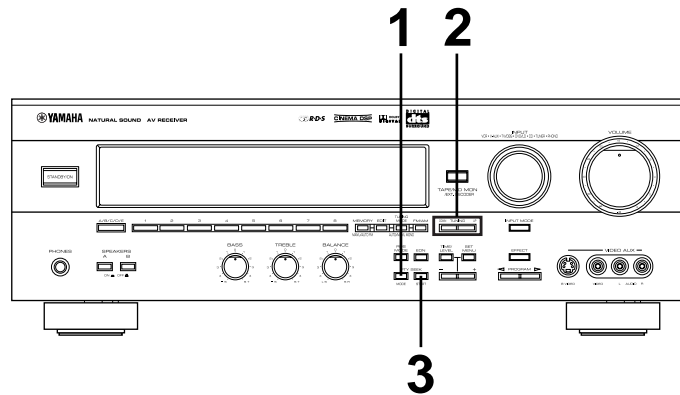

- 1** Press **PTY SEEK MODE** to set the unit in the PTY SEEK mode.

Front panel

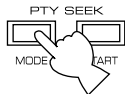

The program type of the station being received or "NEWS" flashes on the display.

- 2** Press **TUNING** (UP side or DOWN side) to select the desired program type.

Front panel

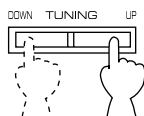

- 3** Press **PTY SEEK START** to begin searching all preset RDS stations.

Front panel

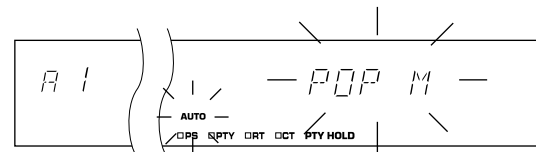
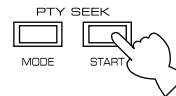

Flashes

- * The "PTY HOLD" indicator lights up on the display.
- * If the station that is broadcasting a program of the required type is found, the unit stops at the station and displays the frequency of the station.
- * If the called station is not the desired one, press **PTY SEEK START** once more. The unit begins searching for another station that is broadcasting a program of the same type.

To cancel this function

Press **PTY SEEK MODE** twice.

PROGRAM TYPES IN THE PTY MODE

NEWS	News	VARIED	Light entertainment
AFFAIRS	Current affairs	POP M	Pops
INFO	General information	ROCK M	Rock
SPORT	Sports	M.O.R. M	Middle-of-the-road music (easy-listening)
EDUCATE	Education	LIGHT M	Light classics
DRAMA	Drama	CLASSICS	Serious classics
CULTURE	Culture	OTHER M	Other music
SCIENCE	Science		

EON FUNCTION

This function uses the EON data service on the RDS station network.

By simply selecting the desired program type (NEWS, INFO, AFFAIRS or SPORT), the unit will automatically monitor all preset RDS stations that broadcast a program of that type and switch from the program being currently received to that program when the broadcast starts.

* This function can only be used when an RDS station that employs the EON data service is being received. (When such a station is being received, the "EON" indicator lights up on the display.)

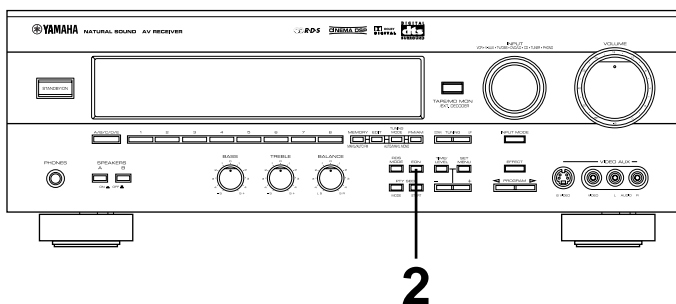

- 1** Make sure that the "EON" indicator lights up on the display.

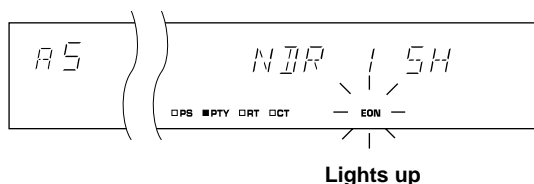

* If the "EON" indicator does not light up on the display, tune in to another RDS station so that the "EON" indicator lights up.

- 2** Press **EON** once or more to select the desired program type (NEWS, INFO, AFFAIRS or SPORT).

Front panel



If a preset RDS program of the designated type starts broadcasting, the unit will automatically switch from the program being currently received to that program.

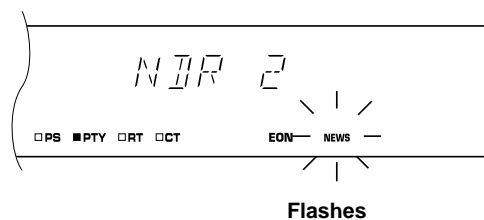

- 3** When broadcasting of the called program ends, the previously received program (or another program on the same station) is recalled.

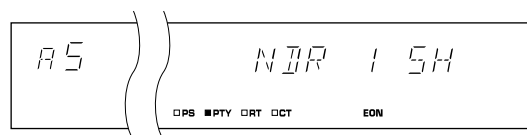

To cancel this function

Press **EON** once or more so that no program type name lights up on the display.

SETTING THE SLEEP TIMER

The SLEEP timer can be used to make this unit automatically switch to the standby mode. When you are going to sleep while enjoying a broadcast or other desired input source, this timer function is useful. The SLEEP timer can only be controlled with the remote control.

Notes

- To set the SLEEP timer for this unit, set the SELECTOR DIAL to a position other than the TV position. To set the SLEEP timer for your TV, set the SELECTOR DIAL to the TV position.
- The components for which the SLEEP timer is effective are the sources connected to the **AC OUTLET(S)** on the rear panel of this unit.

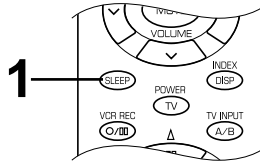

To set the SLEEP time

- 1 Play the source which you want to enjoy when you are going to sleep and press **SLEEP** once or more to select the desired SLEEP time.

Remote control



The SLEEP time is displayed.

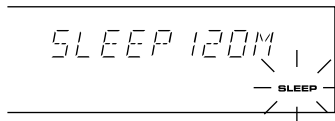

Flashes

Each time you press **SLEEP**, the SLEEP time will change as follows:

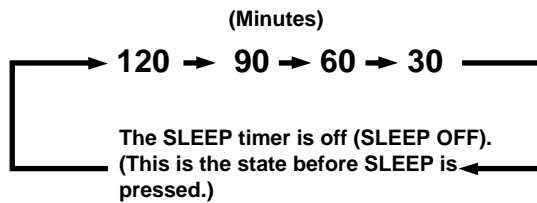

The "SLEEP" indicator soon lights up and the display returns to the indication before the SLEEP timer was set.

- 2 The unit will be switched to the standby mode automatically at the selected SLEEP time.

To cancel the selected SLEEP time

Remote control



Press **SLEEP** once or more so that "SLEEP OFF" appears on the display. (It will soon disappear and the "SLEEP" indicator will go off from the display.)

Note

The SLEEP timer setting can also be canceled by setting the unit in the standby mode with **STANDBY/ON** on the front panel (or **STANDBY** on the remote control) or by disconnecting the power plug of the unit from the AC outlet.









SOUND FIELD PROGRAM

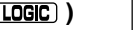

This unit incorporates a sophisticated, multi-program digital sound field processor. This processor allows you to electronically expand and change the shape of the audio sound field from both audio and video sources, creating a theater-like experience in your listening room. You can create outstanding audio sound by selecting a suitable sound field program (this will, of course, depend on what you are listening to) and adding any desired adjustments.

The operation of built-in decoders (Dolby Pro Logic, Dolby Digital and DTS) can be controlled by selecting a corresponding DSP program incorporating the combined operation of YAMAHA DSP and Dolby Surround, Dolby Digital or DTS.

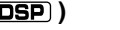
The following list gives you a brief description of the sound fields produced by each of the DSP programs. Keep in mind that most of these are precise digital re-creations of actual acoustic environments.

For movie or audio/video sources

No.	PROGRAM	FEATURES
1	<p>Normal Program</p> <p>[1] DOLBY PRO LOGIC ()</p> <ul style="list-style-type: none"> • Input source : Dolby Surround 2-ch Dolby Digital • Output channel : 4 channels • DSP : — <p>[2] DOLBY DIGITAL ()</p> <ul style="list-style-type: none"> • Input source : Dolby Digital • Output channel : 5.1 channels • DSP : — <p>[3] DTS ()</p> <ul style="list-style-type: none"> • Input source : DTS • Output channel : 5.1 channels • DSP : — 	<p>The built-in Dolby Pro Logic, Dolby Digital or DTS decoder precisely reproduces the sound and effect of the encoded source.</p> <p>The realization of a highly efficient decoding process improves cross talk and channel separation and makes sound positioning smoother and more precise.</p>
2	<p>Enhanced Program</p> <p>[1] DOLBY PRO LOGIC/Enhanced ( )</p> <ul style="list-style-type: none"> • Input source : Dolby Surround 2-ch Dolby Digital • Output channel : 4 channels • DSP : 1 (surround) <p>[2] DOLBY DIGITAL/Enhanced ( )</p> <ul style="list-style-type: none"> • Input source : Dolby Digital • Output channel : 5.1 channels • DSP : 2 (surround L, R) <p>[3] DTS/Enhanced ( )</p> <ul style="list-style-type: none"> • Input source : DTS • Output channel : 5.1 channels • DSP : 2 (surround L, R) 	<p>This program ideally simulates the multi-surround speaker systems of the 35 mm-film movie theater. Each decoding and digital sound field processing operation is precisely performed without altering the original sound orientation.</p> <p>The surround effect produced by the sound field folds around the viewer naturally from the rear to the left and right and toward the screen.</p>

No.	PROGRAM	FEATURES
3	<p>CINEMA DSP Program</p> <p>[1] 70 mm MOVIE THEATER ()</p> <ul style="list-style-type: none"> • Input source : Dolby Surround 2-ch Dolby Digital • Output channel : 3 channels • DSP : 2 (presence & surround) <p>[2] 70 mm MOVIE THEATER – DOLBY D. ()</p> <ul style="list-style-type: none"> • Input source : Dolby Digital • Output channel : 5.1 channels • DSP : 3 (presence & surround L, R) <p>[3] 70 mm MOVIE THEATER – DTS ()</p> <ul style="list-style-type: none"> • Input source : DTS • Output channel : 5.1 channels • DSP : 3 (presence & surround L, R) 	<p>Creates the extremely wide sound field of a movie theater. It precisely reproduces the source sound in detail, giving both the video and the sound field incredible reality. Any kind of video source encoded with Dolby Digital or DTS (especially large-scale movie productions) is ideal for use with this program.</p>
4	<p>MONO MOVIE</p> <ul style="list-style-type: none"> • Input source : Monaural • Output channel : 1 • DSP : 1 	<p>This program is designed specifically to enhance monaural sources. Compared to a strictly mono setting, the sound image is wider and slightly forward of the speaker pair, lending an immediacy to the overall sound.</p>
5	<p>TV SPORTS</p> <ul style="list-style-type: none"> • Input source : Audio/Video • Output channel : 2 to 5.1 channels • DSP : 2 to 3 (presence & surround) 	<p>This program is furnished with a tight sound field in which the sound will not spread excessively at the front, but the rear surround produces dynamic sound expansion.</p>

For Hi-Fi Audio sources

No.	PROGRAM	FEATURES
6	<p>Hi-Fi DSP Program</p> <ul style="list-style-type: none"> • Input source : 2-ch PCM/Analog audio • Output channel : 2 channels • DSP : 1 <p>[1] DISCO</p> <p>[2] ROCK CONCERT</p> <p>[3] CONCERT HALL</p>	<p>Simulates the acoustics of disco in the heart of a lively city. The sound is dense and highly concentrated.</p> <p>Ideally suited for rock music. You will experience a dynamic and lively sound field.</p> <p>Creates the expansive ambience of a large concert hall. Orchestra and opera music are suited to this program.</p>

PLAYING A SOURCE WITH THE DIGITAL SOUND FIELD PROCESSOR (DSP) EFFECT

Follow steps 1 to 7 shown in "TO PLAY A SOURCE" on pages 24 to 25.

Select the desired DSP program that is suitable for the source.

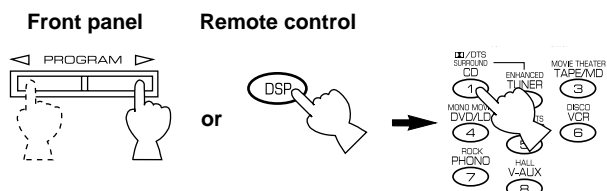

Press **DSP**. While the indicator is lit up for about three seconds, select a DSP program with the numeric buttons (1 to 8).

- * If the SELECTOR DIAL is set to the DSP position, you can also select a DSP program directly with the numeric buttons (1 to 8).

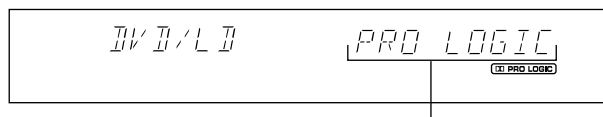

The name of the selected program appears on the display.

If desired, adjust the delay time and the output level of each speaker. (See pages 40 and 41 for details.)

The following indicators on the display show you what sound processing is being undertaken.

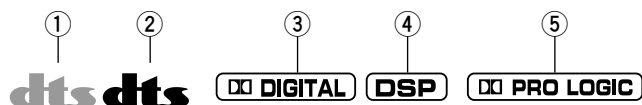

- ① This lights up in orange when a DVD source encoded with DTS is played back and DTS is decoded.
- ② This lights up in red when an LD source or a CD source encoded with DTS is played back and DTS is decoded.
- ③ This lights up when Dolby Digital is being decoded and the signals of the selected source encoded with Dolby Digital is not in 2-channel.
- ④ This lights up when the digital sound field processor is turned on.
- ⑤ This lights up when Dolby Surround is being decoded by Dolby Pro Logic.

TO CANCEL THE SOUND EFFECT

To cancel the sound effect and monitor only the main sound, press **EFFECT** or **EFCT ON/OFF**. Press **EFFECT** or **EFCT ON/OFF** once more to turn sound effect back on.

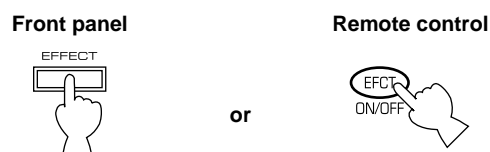

Notes

- You can select a program for each of the input sources. Once you select a program, it is linked with the input source selected at that time. So, when you select the input source next time, the same program is automatically called up.
- When a monaural sound source is being played with **DOLBY PRO LOGIC** or **DOLBY PRO LOGIC ENHANCED**, no sound will be heard from the main speakers and the rear speakers. Sound can only be heard from the center speaker. However, if the NONE position is selected for "CNTR" in the SET MENU mode, the main speakers will output the sound of the center channel.
- When the source of signals input to the **EXTERNAL DECODER INPUT** terminals of this unit is selected, DSP cannot be used.
- If the sound effect is canceled when signals encoded with Dolby Digital or DTS are input to this unit, the signals of all channels are mixed and are output from the main speakers.
- If **EFFECT** or **EFCT ON/OFF** is pressed to turn the sound effects off when Dolby Digital or DTS is decoded, it may happen that the sound is output faintly or not output normally, depending on the source. In that case, press **EFFECT** or **EFCT ON/OFF** to turn on the sound effects.

If you change the LD (or CD) being played back with DTS being decoded to another disc that is not encoded with DTS when the red "dts" indicator lights up, playing back the newly selected disc will result in no sound output. In this state, the red "dts" indicator flashes to show that this unit is locked in the DTS-decoding mode. To play back the disc normally, change the current DTS-decoding mode to another mode by **INPUT MODE** on the front panel or by **INPUT** on the remote control so that the red "dts" indicator goes off.

ADJUSTING THE DELAY TIME AND SPEAKER OUTPUT LEVELS

When using the digital sound field processor with the Dolby Pro Logic decoder, the Dolby Digital decoder or the DTS decoder, you can adjust the delay time between the main sound and sound effect, and each speaker's output level as you prefer.

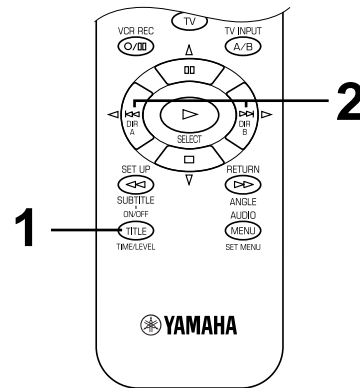
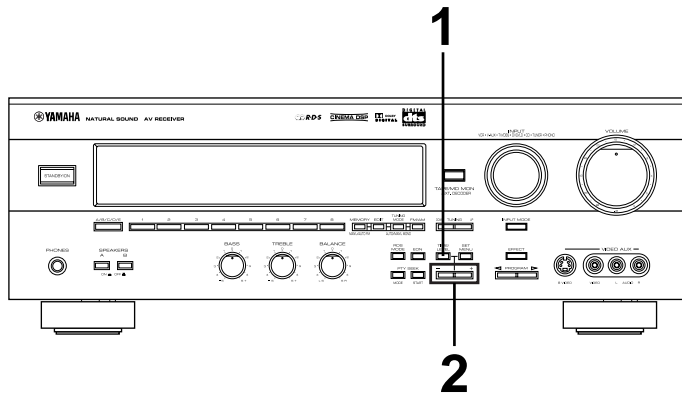

Adjustment method

When adjusting with the remote control, set the SELECTOR DIAL to the AMP/TUN or DSP position on the remote control.



or



1 Press **TIME/LEVEL** once or more until the name of the item which you want to adjust appears on the display.

Front panel

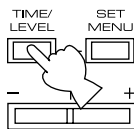

Remote control



or

2 Press **+** or **-** to adjust the settings for the delay time or speaker output levels.

Front panel

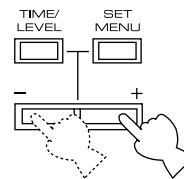

or

Remote control

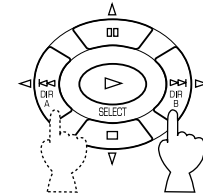

3 Repeat steps 1 and 2 to adjust the settings of any other item.

* After pressing **TIME/LEVEL** once on the remote control, you can also select the name of item by pressing ∇ .

When pressed, the selection changes as follows:

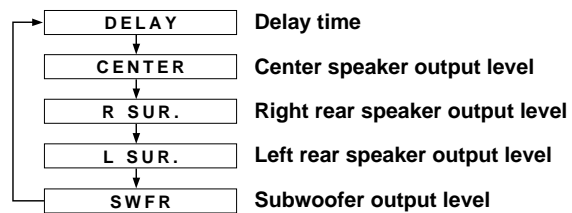

* Pressing Δ on the remote control changes the selection in the reverse order.

* Depending on the setting in the SET MENU mode, you may not be able to select all these items.

Adjusting the delay time

You can adjust the time difference between the beginning of the sound from the main speakers and the beginning of the sound effect from the rear speakers.

The larger the value, the later the sound effect is generated.

This adjustment can be individually made to all programs.

Notes

- Adding too much delay will cause an unnatural effect with some sources.
- When + or – is pressed, the sound is momentarily interrupted.

Program	Control range (ms)	Preset value
1. DOLBY PRO LOGIC	15 to 30	20
DOLBY DIGITAL	0 to 15	5
DTS	0 to 15	5
2. DOLBY PRO LOGIC/Enhanced	15 to 30	20
DOLBY DIGITAL/Enhanced	0 to 15	5
DTS/Enhanced	0 to 15	5
3. 70 mm MOVIE THEATER	15 to 30	20
70 mm MOVIE THEATER – DOLBY D.	1 to 99	16
70 mm MOVIE THEATER – DTS	1 to 99	16
4. MONO MOVIE	1 to 99	49
5. TV SPORTS	1 to 99	9
6. DISCO	1 to 99	40
7. ROCK CONCERT	1 to 99	16
8. CONCERT HALL	1 to 99	44

Adjusting the output level of the center, right rear and left rear speakers, and subwoofer

If desired, you can adjust the sound output level of each speaker even if the output level has already been set in “SPEAKER BALANCE ADJUSTMENT” on pages 21 to 23.

Notes

- The output level of the center speaker cannot be adjusted when the **DISCO**, **ROCK CONCERT** or **CONCERT HALL** program is selected, and the input signal is analog, PCM audio, or encoded with Dolby Digital in 2-channel.
- If the function “CNTR” in the SET MENU mode is set to the NONE position, the sound output level of the center speaker cannot be adjusted. This is because, in this mode, the center speaker sound is automatically output from the left and right main speakers.
- Once the output level has been adjusted, the level will be the same for all digital sound field programs.

Speaker	Control range (dB)	Preset value
CENTER	MIN, –20 to +10	0
RIGHT REAR	MIN, –20 to +10	0
LEFT REAR	MIN, –20 to +10	0
SUBWOOFER	MIN, –20 to 0	0

Memory back-up

The memory back-up circuit prevents the stored data from being lost when this unit is set in the standby mode. If, however, the power plug is disconnected from the AC outlet or the power is cut due to temporary power failure for more than one week, the latest values for the delay time and the center/rear/subwoofer output levels that were set will automatically return to the preset values. If so, they can be re-set by simply following the adjustment method on page 40.

ADJUSTMENTS IN THE “SET MENU” MODE

The following ten types of functions will maximize the performance of your system and expand your enjoyment for audio listening and video watching.

1. **CNTR (CENTER SPEAKER)**
2. **REAR (REAR SPEAKERS)**
3. **MAIN (MAIN SPEAKERS)**
4. **BASS (LFE/BASS OUT)**
5. **M.LVL (MAIN LEVEL)**
6. **D.D.LFE
(DOLBY DIGITAL LFE LEVEL)**
7. **D.RNG (DYNAMIC RANGE)**
8. **DTS LFE (DTS LFE LEVEL)**
9. **C.DELAY (CENTER DELAY)**
10. **GUARD (MEMORY GUARD)**
11. **INPUT (INPUT MODE)**

For details on “CNTR”, “REAR”, “MAIN”, “BASS” and “M.LVL”, see page 19. (Once you have selected the appropriate settings, you do not have to change any settings unless an alteration is made in your speaker system.)

D.D.LFE (Adjusting the level of the LFE channel for Dolby Digital)

Control range: –20 dB to 0 dB (in 1 dB steps)
Preset value: 0 dB

* This adjustment is effective only when Dolby Digital is being decoded and the signals of the selected source encoded with Dolby Digital contain LFE signals.

This adjusts the output level of the LFE channel. If the LFE signals are mixed with signals of other channels and they are output from the same speakers, the ratio of the LFE signal level to the level of the other signals can be adjusted. (See page 6 for details about the LFE channel.)

D.RNG (Adjusting the dynamic range)

Choices: MAX/STD/MIN
Preset position: MAX

* This adjustment is effective only when Dolby Digital is being decoded.

“Dynamic range” is the difference between the maximum level and the minimum level of sounds.

Sounds on a movie originally designed for movie theaters feature a very wide dynamic range. Dolby Digital technology can modify the original sound track into a home audio format with this wide dynamic range unchanged.

Powerful sounds of extremely wide dynamic range are not always suitable for home use. Depending upon the condition of your listening environment, it may not be possible to increase the sound output to a level as high as that in a movie theater.

However, at the normal level suitable for listening in your room, the low-level parts of source sound often cannot be heard well because they will be lost among noise in your environment. Dolby Digital technology has also made it possible to reduce an original sound track’s dynamic range for a home audio format by “compressing” the sound data.

MAX: In this position, a source encoded with Dolby Digital is reproduced in the original sound track’s wide dynamic range to provide you with powerful sounds just like those in a movie theater. Selecting this position will be even better if you can listen to a source at a high output level in a room specially soundproofed for audio/video enjoyment.

STD (Standard):

In this position, a source encoded with Dolby Digital is reproduced in the “compressed” dynamic range of the source that is suitable for low-level listening.

MIN: In this position, the dynamic range is more reduced than in the STD position. Selecting this position will be effective when you must listen to a sound source at a low level.

* In this position, it may happen that sound is output faintly or not output normally depending on the source. In that case, select the MAX or STD position.

DTS LFE (Adjusting the level of the LFE channel for DTS)

Control range: –10 dB to +10 dB (in 1 dB steps)
Preset value: 0 dB

* This adjustment is effective only when DTS is being decoded and the signals of the selected source encoded with DTS contain LFE signals.

This adjusts the output level of the LFE channel. If the LFE signals are mixed with signals of other channels and they are output from the same speakers, the ratio of the LFE signal level to the level of the other signals can be adjusted. (See page 6 for details about the LFE channel.)

C.DELAY [Adjusting the delay of center sounds (dialog, etc.)]

Control range: 0 ms to 5 ms (in 1 ms steps)
Preset value: 0 ms

- * This adjustment is effective only when Dolby Digital or DTS is being decoded and the signals of the selected source encoded with Dolby Digital or DTS contain center-channel signals.

This adjusts the delay between the main sound (on the main channels) and dialog, etc. (on the center channel). The larger the value, the later the dialog, etc. is generated.

This is for making sounds from the left main, center and right main speakers reach your listening position at the same time. This is achieved by delaying the sound from the center speaker if the distance from the center speaker to your listening position is shorter than the distance from the left or right main speaker to your listening position.

GUARD (Memory guard)

Choices: ON/OFF
Preset position: OFF

If you wish to prevent accidental alterations to SET MENU and other adjustments on this unit, select ON. The following functions on this unit can be locked by this operation:

- Other functions in the SET MENU mode
- Functions in the TIME/LEVEL mode
- Functions when using TEST

INPUT (Selecting the mode of the TV/DBS input)

Choices: AUTO/LAST
Preset position: AUTO

You can designate the input mode that is automatically selected when the power of this unit is switched on for only the sources connected to the TV/DBS input terminals of this unit.

- AUTO:** In this position, the AUTO input mode is always selected when the power for this unit is switched on.
- LAST:** In this position, the input mode you selected last time is memorized and will not be changed when the power is switched on again.

- * See page 26 for details on switching the input mode.

Adjustment method

Adjustments should be made while watching the information on this unit's display.

When adjusting with the remote control, set the SELECTOR DIAL to the AMP/TUN or DSP position on the remote control.

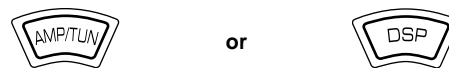

Press **SET MENU** once or more so that the function which you want to change appears on the display.

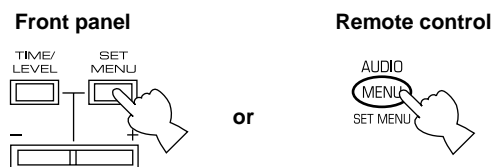

- * After pressing **SET MENU** once on the remote control, you can also select the title by pressing ∇ . (Pressing Δ goes back one selection.)

Press **+** or **-** to select any desired position or to edit parameters of the chosen function.

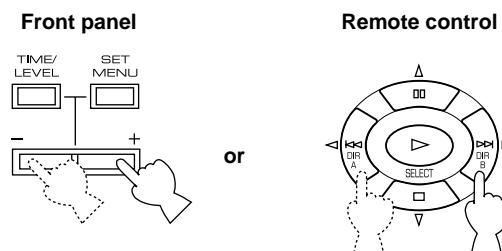

Repeat these steps to change or adjust the settings of any other function.

Memory back-up

The memory back-up circuit prevents the stored data from being lost when this unit is set in the standby mode. If, however, the power plug is disconnected from the AC outlet or the power is cut due to temporary power failure for more than one week, the settings of the SET MENU mode will automatically return to the factory settings. If so, they can be re-set by simply following the procedure above.

REMOTE CONTROL

You can use the remote control to control not only this unit but also other components connected to it. The remote control is factory set to control this unit and most YAMAHA audio components.

To control other brands of components, you must preset the remote control with the manufacturers' codes listed from page 369.

Components which can be controlled

There are nine positions that you can select to control connected components with this remote control. When turning the SELECTOR DIAL, the position changes as follows:

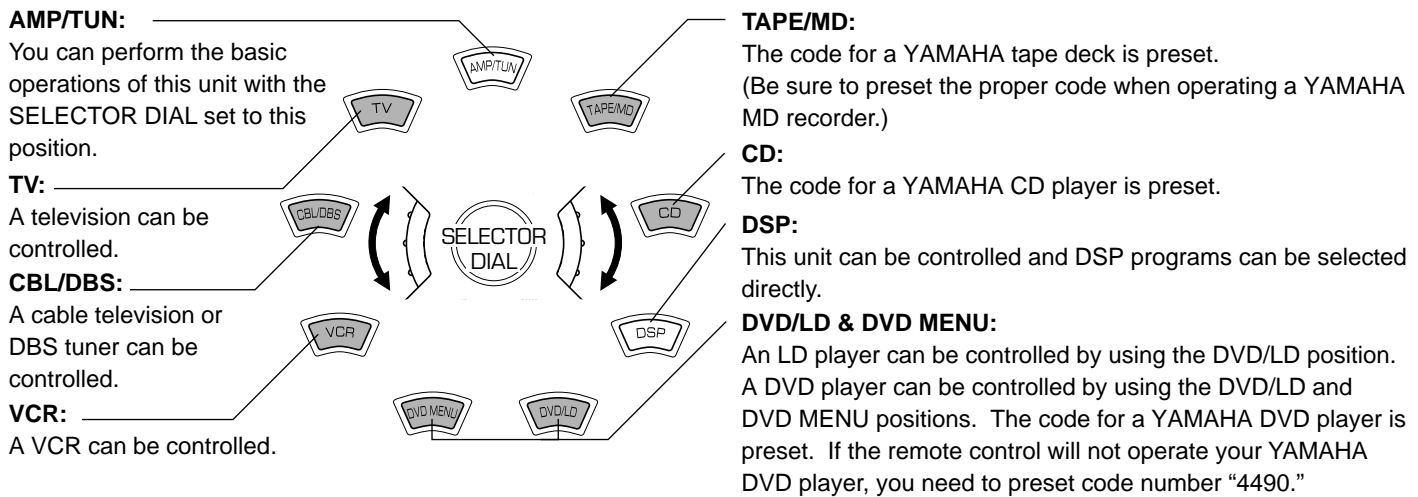

Notes

- The shaded positions in the diagram above indicate that you can preset the code for the manufacturer of your component. Note that you can preset only one code for one position. (See "SETUP CODES" on page 50 for details).
- DVD/LD and DVD MENU positions:
 - Be sure that the SELECTOR DIAL is set to the DVD/LD position before presetting the code for a DVD or an LD player. The code that you preset to the DVD/LD position is also simultaneously preset to the DVD MENU position. You cannot preset the code for a DVD player when the SELECTOR DIAL is set to the DVD MENU position.
 - DVD MENU operations cannot be performed for some DVD players.
- When using a second (and third) VCR (See "To use a second (and third) VCR" on page 50 for details.):
 - If you are not using a CBL/DBS (cable TV or DBS tuner), the second (or third) VCR can be preset by using the CBL/DBS position.
 - If you are not using a DVD player, the second (or third) VCR can be preset by using the DVD MENU position. Note that in this case you must preset the code for an LD player to the DVD/LD position even if an LD player is not being used.
- The button functions on the remote control differ depending on the position selected by the SELECTOR DIAL. Refer to the following pages for details.

Basic operation

- Select the position for the component that you want to control by turning the SELECTOR DIAL.
Note: Turn the SELECTOR DIAL until it stops with a click.

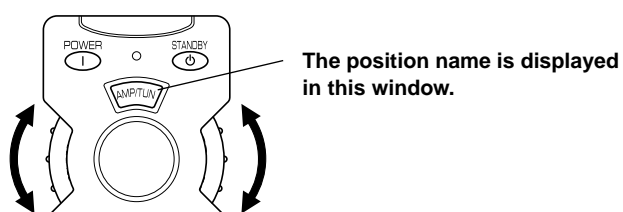

- Press the desired operation button.
Note: Press the button with the remote control aimed at the front panel.

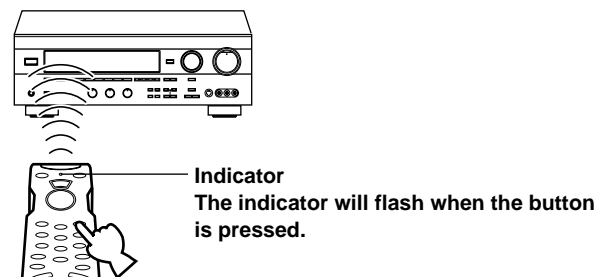

The lightly marked buttons do not function.

AMP/TUN

Note: TV POWER and TV VOLUME function if you have preset the code for your TV.

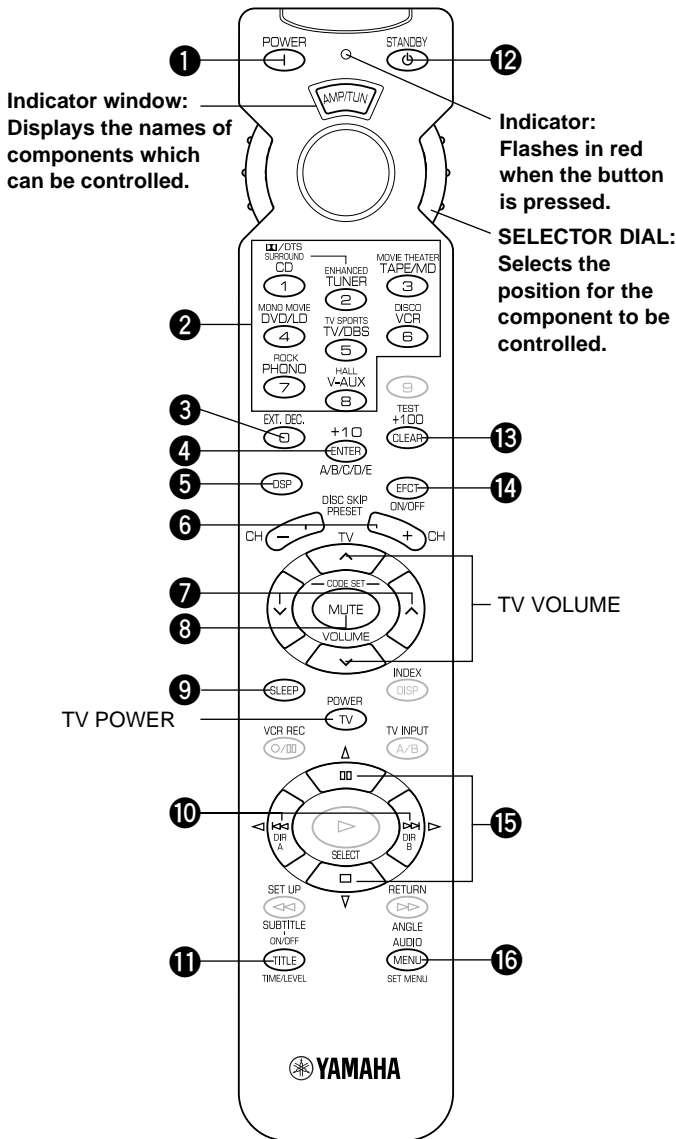

Indicator window:
Displays the names of components which can be controlled.

Indicator:
Flashes in red when the button is pressed.

SELECTOR DIAL:
Selects the position for the component to be controlled.

- 1 POWER**
This button turns the unit on.
- 2 INPUT**
Press one of these buttons to select the required input source.
- 3 EXT. DEC.**
Press this button when using an external decoder.
- 4 A/B/C/D/E**
Press this button to select a group of preset stations.
- 5 DSP**
Press this button. While the indicator is lit up for about three seconds, select a DSP program by using the number buttons (1 to 8). No DSP program can be selected after the indicator goes off.
- 6 PRESET (+/-)**
Press these buttons to select the preset station number.
- 7 VOLUME (^ v)**
Press these buttons to adjust the volume level.
- 8 MUTE**
Press this button to mute the sound. To cancel mute, press this button once more, or press the operation buttons of this unit.
- 9 SLEEP**
Press this button to set the SLEEP timer.
- 10 < (LEFT), > (RIGHT)**
These buttons are used to adjust the settings of the SET MENU mode and the TIME/LEVEL mode.
- 11 TIME/LEVEL**
Press this button to set the unit in the TIME/LEVEL mode and to select the item.
- 12 STANDBY**
Press this button to set this unit in the standby mode.
- 13 TEST**
Press this button to output a test tone for adjusting the output level of the speakers.
- 14 EFCT (EFFECT) ON/OFF**
Press this button to turn on or off the DSP program which includes the Dolby Pro Logic decoder, the Dolby Digital decoder and the DTS decoder.
- 15 ▽ (NEXT), ▲ (BACK)**
These buttons are used to advance or go back one selection in the SET MENU mode and TIME/LEVEL mode.
- 16 SET MENU**
Press this button to set the unit in the SET MENU mode and to select functions.

DSP

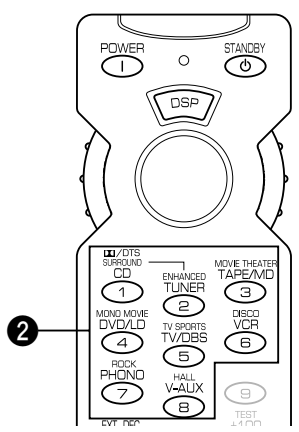

- 2 DSP program**
Press one of these buttons to select the required DSP program (1 to 8). When you select the input source, set the SELECTOR DIAL to the AMP/TUN position.

Note: The function of all buttons other than DSP program is the same as that with the AMP/TUN position.

The lightly marked buttons do not function. See "AMP/TUN" on page 45 for those buttons which are not described here. Please refer to the owner's manual for details of each component.

■ TAPE/MD

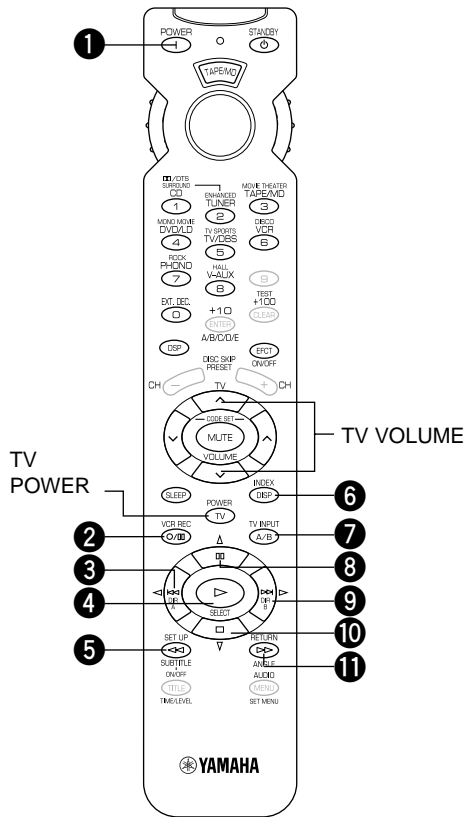

Notes:

- **TV POWER** and **TV VOLUME** function if you have preset the code for your TV.
- Be sure to preset the proper code for your MD recorder.

TAPE

1 POWER

This button turns the unit on under factory settings. If another code for your tape deck whose remote control has a power button is preset, the button will turn on the tape deck.

2 ○/⏸ (REC/PAUSE)

Press this button to give a pause in recording on the tape deck.

3 ◀ DIR A

Press this button to select the playing direction of deck A.

4 ▷ (PLAY)

Press this button to play a tape.

5 ◀◀ (REWIND)

Press this button to rewind a tape.

7 DECK A/B

Press this button to select deck A or B on the double cassette tape deck.

9 ▷ DIR B

Press this button to select the playing direction of deck B.

10 ◻ (STOP)

Press this button to stop the operation of a tape.

11 ▷▷ (FAST FORWARD)

Press this button to fast forward a tape.

MD

1 POWER

This button turns the unit on if you have preset the code for the YAMAHA MD recorder. If another code for your MD recorder whose remote control has a power button is preset, the button will turn on the MD recorder.

2 ○/⏸ (REC/PAUSE)

3 ⏮ (SKIP)

4 ▷ (PLAY)

5 ◀◀ (SEARCH)

6 DISP (DISPLAY)

8 ⏸ (PAUSE)

9 ▷▷ (SKIP)

10 ◻ (STOP)

11 ▷▷ (SEARCH)

■ CD

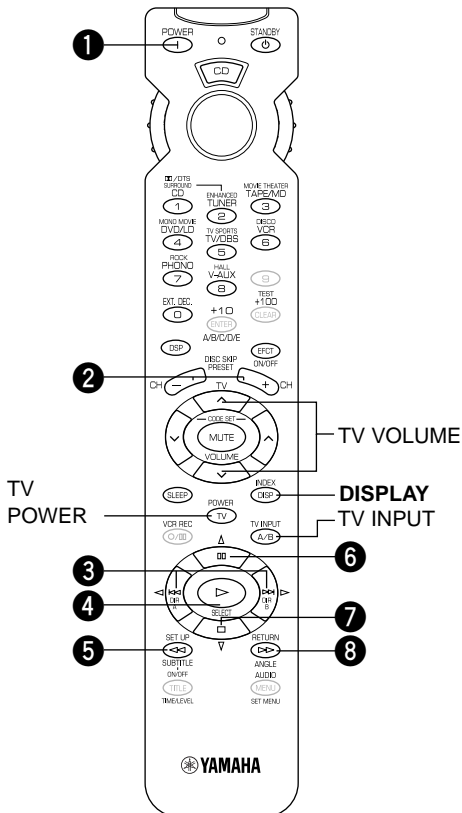

Note: **TV POWER**, **TV VOLUME** and **TV INPUT** function if you have preset the code for your TV.

1 POWER

This button turns the unit on under factory settings. If another code for your CD player whose remote control has a power button is preset, the button will turn on the CD player.

2 DISC SKIP (+/-) (for a CD player with a CD changer)

Press these buttons to skip the next or previous CD.

3 ▷▷, ◀◀ (SKIP)

Press ▷▷ to skip to the beginning of the next track. Press ◀◀ to skip to the beginning of the previous track.

4 ▷ (PLAY)

Press this button to play a CD.

5 ◀◀ (SEARCH)

This button initiates a backward search on the track that is playing to find the point from which you want to listen.

6 ⏸ (PAUSE)

Press this button to give a pause in operation. This button functions as **PAUSE/STOP*** for operating YAMAHA CD players under factory settings.

7 ◻ (STOP)

Press this button to stop operation. This button functions as **PAUSE/STOP*** for operating YAMAHA CD players under factory settings.

8 ▷▷ (SEARCH)

This button initiates a fast-forward search on the track that is playing to find the point from which you want to listen.

* **PAUSE/STOP** function ... Press the button once to give a pause in operation and once more to stop operation.

The lightly marked buttons do not function. See “AMP/TUN” on page 45 for those buttons which are not described here. Please refer to the owner’s manual for details of each component.

DVD/LD

POWER

(DVD) This button turns the unit on under factory settings. If another code for your DVD player whose remote control has a power button is preset, the button will turn on the DVD player.
(LD) This button turns the unit on if you have preset the code for the YAMAHA LD player. If another code for your LD player whose remote control has a power button is preset, the button will turn on the LD player.

Note: TV POWER, TV VOLUME and TV INPUT function if you have preset the code for your TV.

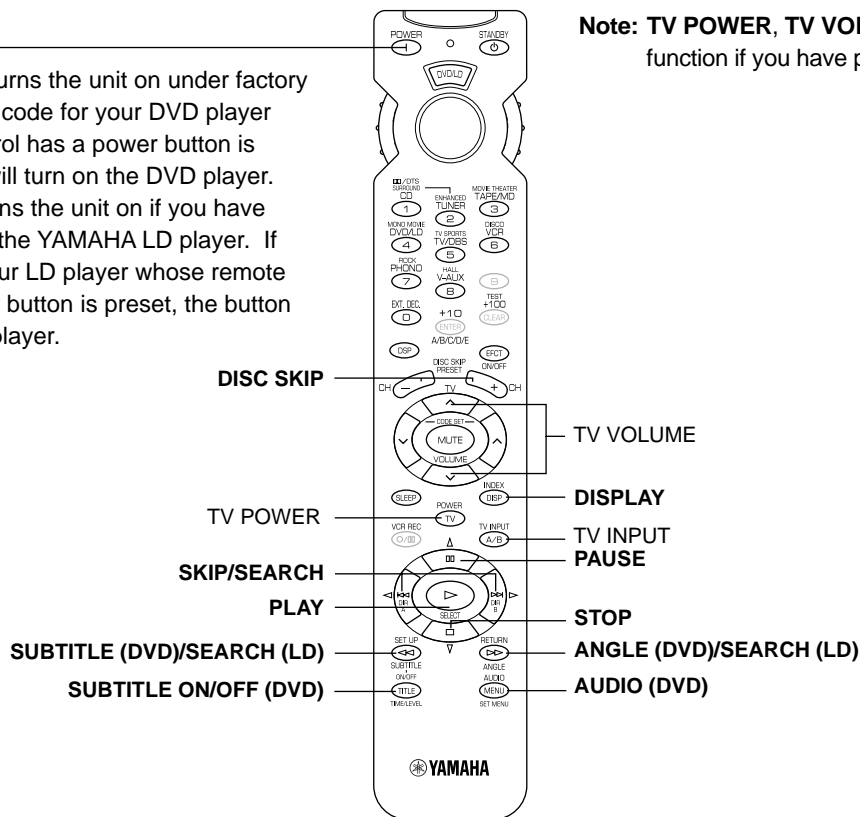

DVD MENU

POWER

This button turns the unit on under factory settings. If another code for your DVD player whose remote control has a power button is preset, the button will turn on the DVD player.

Note: TV POWER, TV VOLUME and TV INPUT function if you have preset the code for your TV.

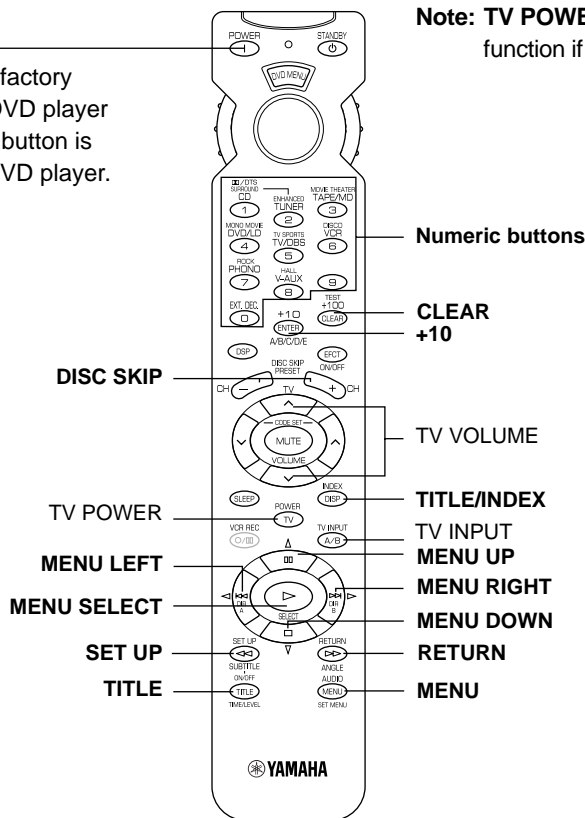

The lightly marked buttons do not function. See "AMP/TUN" on page 45 for those buttons which are not described here. Please refer to the owner's manual for details of each component.

VCR

Note: TV POWER, TV VOLUME and TV INPUT function if you have preset the code for your TV.

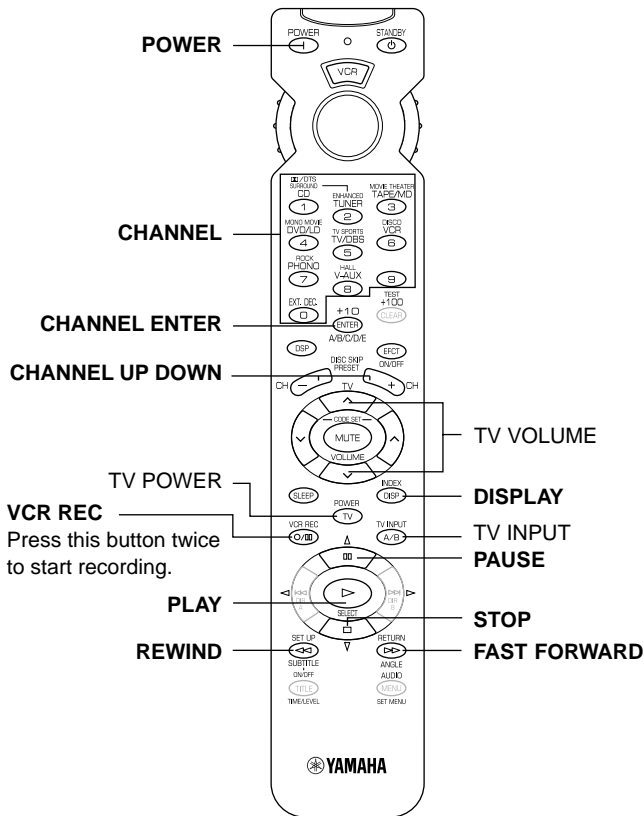

TV

Note: You can only control your VCR if you have preset the code for it.

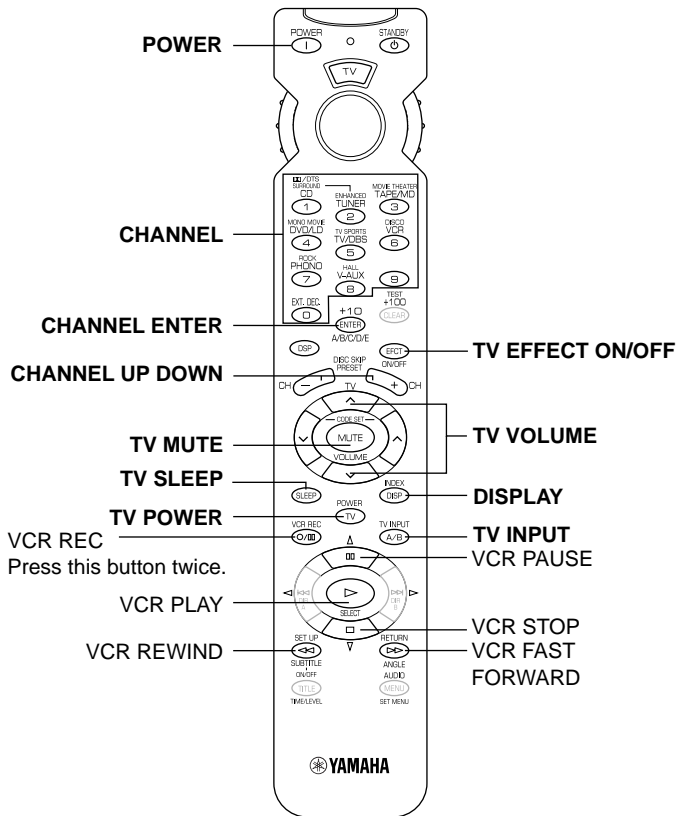

CBL/DBS

Note: TV POWER, TV VOLUME and TV INPUT function if you have preset the code for your TV.

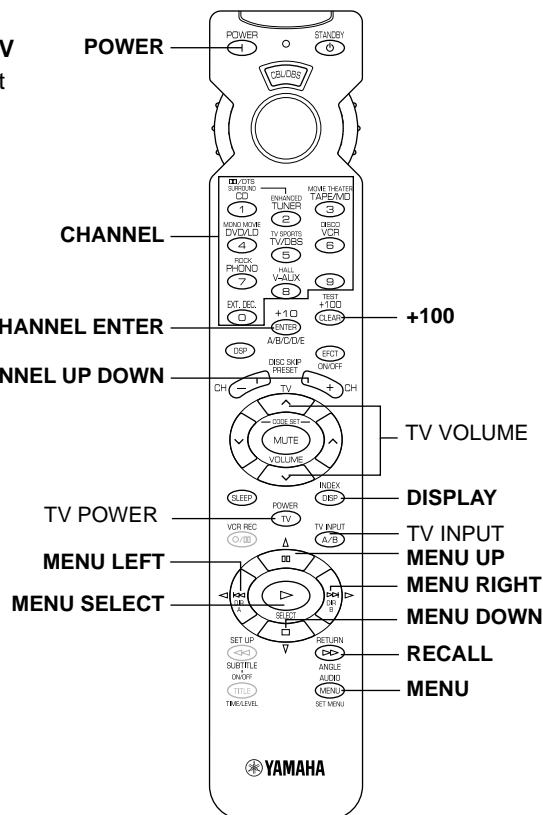

NOTES ABOUT THE REMOTE CONTROL

Battery installation

1. Turn the remote control over and slide the battery compartment cover in the direction of the arrow.
2. Insert the batteries (AA, R6 or UM-3 type) according the polarity markings on the inside of the battery compartment.
3. Close the battery compartment cover.

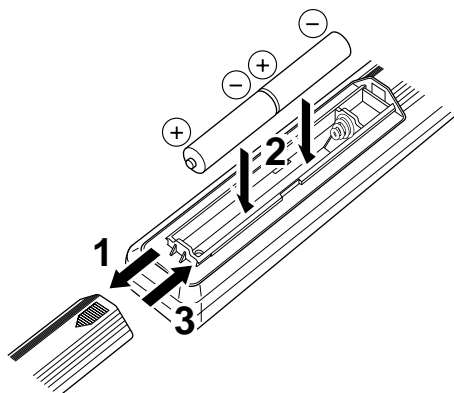

Battery replacement

If the remote control operates only when it is close to the unit, the batteries are weak. Replace all the batteries with new ones.

Be sure to replace the batteries within about two minutes. If it takes longer than two minutes, the codes preset for the remote control will return to the factory settings.

Notes

- Use only AA, R6 or UM-3 batteries for replacement.
- Be sure the battery polarity is correct. (See the illustration inside the battery compartment.)
- Remove the batteries if the remote control will not be used for an extended period of time.
- If the batteries have leaked, dispose of them immediately. Avoid touching the leaked material or letting it come into contact with clothing, etc. Clean the battery compartment thoroughly before installing new batteries.

Remote control operation range

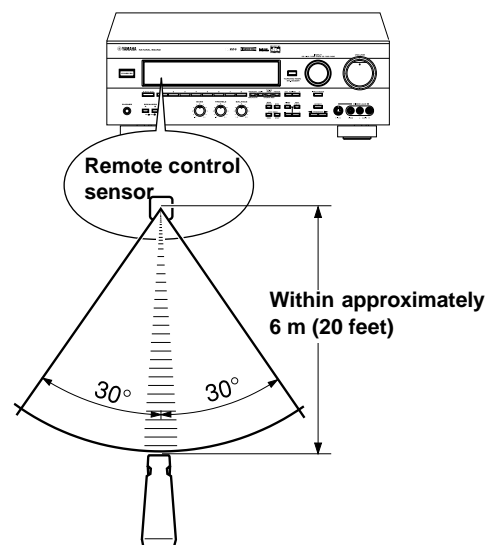

Notes

- There should be no large obstacles between the remote control and the unit.
- If the remote control sensor is directly illuminated by strong lighting (especially from an inverter type of fluorescent lamp), it might cause the remote control not to work correctly. In this case, reposition the unit to avoid direct lighting.

SETUP CODES

Presetting the remote control

Perform the presetting procedure for each component you want to control with the remote control.

Note: If your component does not respond to any of the codes listed for the manufacturer, use the original remote control that was supplied with the component.

To control your components (MD recorder, DVD player, TV, etc.)

1. Turn on the component to be used.
2. Set the SELECTOR DIAL to the desired position for the component (TAPE/MD, DVD/LD, TV, etc.).

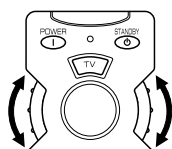

3. Press both **VOLUME** buttons (^) for about four seconds at the same time so that the indicator flashes twice.

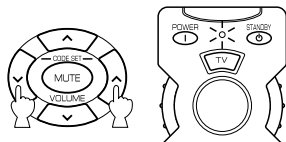

4. Use the numeric buttons to enter the four-digit manufacturer's code for the component to be used. Make sure that the indicator flashes twice. If the indicator does not flash, repeat step 3 and re-enter the code.

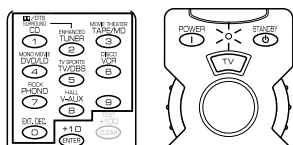

5. Press **POWER** (or any other button) on the remote control to check if you have preset the code correctly. If the component cannot be controlled with the remote control, try entering another code for the same manufacturer.

To use a second (and third) VCR

You can use the CBL/DBS and/or DVD MENU positions to control a second (and/or third) VCR if a CBL (or DBS) or DVD player is not being used.

If you are using the DVD MENU position for a second (or third) VCR, you must preset the code for an LD player to the DVD/LD position.

1. Turn on the VCR to be used.
2. Set the SELECTOR DIAL to the CBL/DBS or DVD MENU position.

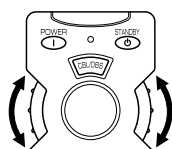

3. Press both **VOLUME** buttons (^) for about four seconds at the same time so that the indicator flashes twice.

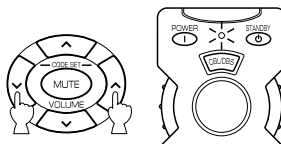

4. Press **MUTE**.

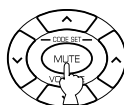

5. Use the numeric buttons to enter the four-digit code for the second (or third) VCR. Make sure that the indicator flashes twice. If the indicator does not flash, repeat steps 3 and 4, and re-enter the code.

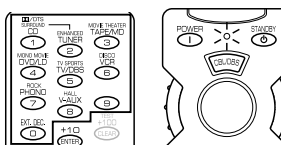

6. Press **POWER** (or any other button) on the remote control to check if you have preset the code correctly. If the VCR cannot be controlled with the remote control, try entering another code for the same manufacturer.

Returning to the factory-set codes

To return all components to the factory-set codes, follow these steps.

1. Set the SELECTOR DIAL to a position other than the AMP/TUN or DSP position.
2. Press both **VOLUME** buttons (^) for about four seconds at the same time so that the indicator flashes twice.
3. Enter code number "9987".
4. Make sure that the indicator flashes twice.

To return each component to the factory-set code, follow these steps.

1. Set the SELECTOR DIAL to the position for the component to be returned to the factory-set code.
2. Press both **VOLUME** buttons (^) for about four seconds at the same time so that the indicator flashes twice.
3. Enter code number "9999".
4. Make sure that the indicator flashes twice.

The following codes are preset as the factory settings.

Factory-set codes

POSITION	Component	Code
TV	TV	0037
CBL/DBS	DBS tuner	2455
VCR	VCR	3072
DVD/LD	DVD player	4545 YAMAHA
CD	CD player	6187 YAMAHA
TAPE/MD	Tape deck	8524 YAMAHA

We recommend that you write all the code numbers you have preset on the "Quick Reference Card."

TROUBLESHOOTING

If the unit fails to operate normally, check the following points to determine whether the fault can be corrected by the simple measures suggested. If it cannot be corrected, or if the fault is not listed in the SYMPTOM column, disconnect the power cord and contact your authorized YAMAHA dealer or service center for help.

	SYMPTOM	CAUSE	REMEDY
Amplifier	The unit fails to turn on when STANDBY/ON is pressed, or set in the standby mode suddenly soon after the power has been turned on.	The power cord is not plugged in or the plug is not completely inserted.	Firmly plug in the power cord.
		The IMPEDANCE SELECTOR switch on the rear panel is not fully set to the upper or lower end.	Set the switch fully to the upper or lower end when the unit is in the standby mode.
	The unit does not work normally.	The internal microcomputer has been frozen by an external electric shock (lightning, excessive static electricity, etc.) or by a power supply with low voltage.	Set the unit in the standby mode and disconnect the AC power cord from the AC outlet. After about 30 seconds have passed, connect the power and operate the unit again.
	No sound or no picture.	Incorrect output cord connections.	Connect the cords properly. If the problem persists, the cords may be defective.
		An appropriate input source has not been selected.	Select an appropriate input source with INPUT or TAPE/MD MON / EXT. DECODER .
		SPEAKERS have not been set properly.	Set SPEAKERS corresponding to the speakers in use to the ON position.
		The speaker connections are not secure.	Secure the connections.
		Digital signals other than PCM audio and Dolby Digital or DTS encoded signals which this unit cannot reproduce are input to this unit by playing a CD-ROM etc.	Play a source whose signals this unit can reproduce.
	No picture.	There is no S video terminal connection between this unit and the TV, although S video signals are input to this unit.	Connect this unit's S VIDEO MONITOR OUT terminal to the TV's S video input terminal.
	The sound suddenly goes off.	The protection circuit has been activated because of a short circuit, etc.	Set the unit in the standby mode and then switch on again to reset the protection circuit.
		The SLEEP timer has functioned.	Turn on the power, and play the source again.
	Only the speakers on one side can be heard.	Incorrect setting of BALANCE .	Adjust it to the appropriate position.
		Incorrect cord connections.	Connect the cords properly. If the problem persists, the cords may be defective.
	A "humming" sound can be heard.	Incorrect cord connections.	Firmly connect the audio plugs. If the problem persists, the cords may be defective.
		No connection from the turntable to the GND terminal.	Make the GND connection between the turntable and this unit.
The volume level is low while playing a record.	The record is being played on a turntable with an MC cartridge.	The turntable should be connected to the unit through the MC head amplifier.	
The volume level cannot be increased, or the sound is distorted.	The component connected to the REC OUT terminals of this unit is in the standby mode.	Turn on the power to the component.	

	SYMPTOM	CAUSE	REMEDY
Amplifier	No sound from the effect speakers.	The sound effect setting is off.	Press EFFECT on the front panel or EFCT ON/OFF on the remote control to turn it on.
		A Dolby Surround or DTS decoding program is being used with material not encoded with Dolby Surround or DTS.	Use a different sound field program.
	No sound from the rear speakers.	The sound output level of the rear speakers is set to minimum.	Raise the sound output level of the rear speakers.
		A monaural sound source is being played in the DOLBY PRO LOGIC or DOLBY PRO LOGIC ENHANCED program.	Select another sound field program suitable for the monaural sound source.
	No sound from the center speaker.	The sound output level of the center speaker is set to minimum.	Raise the sound output level of the center speaker.
		The function "CNTR" in the SET MENU is set to the NONE position.	Select the LARGE or SMALL position.
		Incorrect sound field program selection.	Select the appropriate program.
		The input signals of the source encoded with Dolby Digital or DTS do not have center channel signals.	Refer to the instructions for the source being currently played.
	The sound field cannot be recorded.	It is not possible to record the sound field on a tape deck or MD recorder connected to the unit's REC OUT terminals.	
	The DVD/LD, TV or DBS source cannot be recorded on a tape deck, MD recorder or VCR connected to this unit.	The DVD/LD player, TV or DBS tuner is connected to the unit by only the digital terminals.	Make additional connections between the analog terminals.
FM	FM stereo reception is noisy.	The characteristics of FM stereo broadcasts may cause this problem when the transmitter is too far away or the antenna input is poor.	Check the antenna connections. Try using a high-quality directional FM antenna. Set TUNING MODE to the manual tuning mode.
	There is distortion and clear reception cannot be obtained even with a good FM antenna.	There is multipath interference.	Adjust the antenna position to eliminate multipath interference.
	The desired station cannot be tuned in with the automatic tuning method.	The station is too weak.	Use the manual tuning method. Use a high-quality directional FM antenna.
	Previously preset stations can no longer be tuned in.	The unit has been unplugged for a long period.	Repeat the presetting procedure.
AM	The desired station cannot be tuned in with the automatic tuning method.	The signal is weak or the antenna connections are loose.	Tighten the AM loop antenna connections and rotate it for best reception. Use the manual tuning method.
	There are continuous crackling and hissing noises.	Noise will result from lightning, fluorescent lamps, motors, thermostats and other electrical equipment.	Use an outdoor antenna and a ground wire. This will help somewhat, but it is difficult to eliminate all noise.
	There are buzzing and whining noises (especially in the evening).	A television set is being used nearby.	Relocate this unit away from the TV.

	SYMPTOM	CAUSE	REMEDY
Remote control	The remote control does not work.	Direct sunlight or lighting (from an inverter type of fluorescent lamp, etc.) is striking the remote control sensor of this unit.	Change the position of this unit.
		The manufacturer's code has not been set properly.	Set the code again.
		The proper manufacturer's code for the component to be controlled has not been set.	Try entering another code for the same manufacturer.
		The component to be controlled has not been selected.	Set the SELECTOR DIAL to the proper position.
Others	The sound is degraded when listening with the headphones to a CD player or tape deck that is connected to this unit.	This unit is in the standby mode.	Turn on the power of the unit.
	There is noise interference from digital or high-frequency equipment or the unit.	The unit is too close to the digital or high-frequency equipment.	Move the unit further away from such equipment.

When playing back a source encoded with DTS

SYMPTOM	CAUSE	REMEDY
A loud hissing noise is heard when you play back a source encoded with DTS.	The player which plays back the source is not connected to a digital audio signal input terminal of this unit.	The player must be connected to a digital audio signal input terminal of this unit besides the analog audio signal terminal connections.
	The ANALOG input mode is selected on this unit.	Select a proper input mode on this unit to turn on the DTS decoder built into the unit.
A percussive noise is heard when you begin playing back a source encoded with DTS.	If the AUTO input mode is selected, depending on some sources, there may be a case that a noise is heard while this unit is identifying the format of the input signal.	Set the input mode of the currently selected input source to DTS.
No sound is heard when you play back a source encoded with DTS, even though the AUTO input mode is selected on this unit.	The DTS decoder built into this unit does not function because the player has a digital volume control and it is set at a position other than "maximum," "neutral" or "ineffective."	Set the player's digital volume control at the maximum, neutral or ineffective position.
No sound is heard when you play back an MD or DAT on to which you have recorded a source encoded with DTS.	A source encoded with DTS cannot be recorded on to an MD or DAT.	
No sound is heard when you play back a source (CD, etc.) even though the currently selected input mode is AUTO.	In the AUTO mode, the DTS-decoding mode cannot be automatically changed to the normal (PCM) digital signal input mode.	Press INPUT MODE on the front panel or INPUT (for the currently selected source) on the remote control so that AUTO appears on the display.

Notes

- It is necessary to use a DTS decoder to play back a source encoded with DTS, so the player which plays back the source must be connected to a digital audio input terminal of this unit in the way described in this manual. If this connection is not made or only a D-to-A converter is being used without using a DTS decoder, when you play back the source, only a loud hissing noise will be heard.
- If you make a search (or skip, etc.) operation while playing back a source encoded with DTS, the "dts" indicator goes out from the display. This is because this unit automatically changes the DTS-decoding mode to the standard (PCM) digital signal input mode to prevent a noise from being output.

SPECIFICATIONS

AUDIO SECTION

Minimum RMS Output Power

8 ohms, 20 Hz to 20 kHz, 0.04% THD	
MAIN L/R	65 W + 65 W
CENTER	65 W
REAR L/R	65 W + 65 W
8 ohms, 1 kHz, 0.07% THD	
MAIN L/R	80 W + 80 W
CENTER	80 W
REAR L/R	80 W + 80 W

Dynamic Power per Channel

(by IHF Dynamic Headroom measuring method)

MAIN L/R	
8/6/4/2 ohms	90/110/135/160 W

DIN Standard Output Power per Channel

[Europe model only]

4 ohms, 1 kHz, 0.7% THD	110 W
-------------------------------	-------

IEC Power

[Europe model only]

8 ohms, 1 kHz, 0.04% THD	75 W + 75 W
-------------------------------	-------------

Power Band Width

MAIN L/R	
8 ohms, 35 W, 0.1% THD	10 Hz to 50 kHz

Damping Factor (SPEAKER A)

8 ohms, 20 Hz to 20 kHz	60 or more
-------------------------------	------------

Input Sensitivity/Impedance

PHONO MM	2.5 mV/47 k-ohms
CD/TAPE-MD/DVD-LD/TV-DBS/VCR/ VIDEO AUX	150 mV/47 k-ohms
EXT. DECODER	
MAIN L/R	150 mV/47 k-ohms
CENTER/SURROUND L/R/SUBWOOFER	150 mV/40 k-ohms

Maximum Input Signal

PHONO MM	
1 kHz, 0.1% THD	100 mV or more
CD/TAPE-MD/DVD-LD/TV-DBS/VCR/ VIDEO AUX (EFFECT ON)	
1 kHz, 0.5% THD	2.2 V or more

Output Level/Impedance

REC OUT	150 mV/1.2 k-ohms
PRE OUT	2.1 V/1.2 k-ohms
SUBWOOFER	
(MAIN SP: SMALL)	4.0 V/1.2 k-ohms

Headphones Jack Rated Output/Impedance

CD/TAPE-MD/DVD-LD/TV-DBS/VCR/ VIDEO AUX input,	
1 kHz, 150 mV, 8 ohms	0.5 V/390 ohms

Frequency Response (20 Hz to 20 kHz)

CD/TAPE-MD/DVD-LD/TV-DBS/VCR/ VIDEO AUX to MAIN L/R SP OUT	0±0.5 dB
--	----------

RIAA Equalization Deviation

PHONO MM	0±0.5 dB
----------------	----------

Total Harmonic Distortion (20 Hz to 20 kHz)

PHONO MM to REC OUT	
1 V	0.02% or less
CD/TAPE-MD/DVD-LD/TV-DBS/VCR/ VIDEO AUX (EFFECT OFF) to MAIN SP OUT	
35 W/8 ohms	0.025% or less

Signal-to-Noise Ratio (IHF-A Network)

PHONO MM to REC OUT	
(5 mV, Input Shorted)	81 dB or more
CD/TAPE-MD/DVD-LD/TV-DBS/VCR/ VIDEO AUX (EFFECT OFF) to MAIN SP OUT	
(150 mV, Input Shorted)	96 dB or more

Residual Noise (IHF-A Network)

MAIN L/R SP OUT	150 µV or less
-----------------------	----------------

Channel Separation

(Vol. -30 dB, EFFECT OFF)

PHONO MM	
(Input Shorted, 1 kHz/10 kHz)	
.....	60 dB or more/55 dB or more
CD/TAPE-MD/DVD-LD/TV-DBS/VCR/ VIDEO AUX	
(Input 5.1 k-ohms Terminated, 1 kHz/10 kHz)	
.....	60 dB or more/45 dB or more

Tone Control Characteristics

BASS: Boost/cut	±10 dB (50 Hz)
Turnover Frequency	350 Hz
TREBLE: Boost/cut	±10 dB (20 kHz)
Turnover Frequency	3.5 kHz

Filter Characteristics

MAIN L/R, REAR L/R (SPEAKER: SMALL) (H.P.F)	fc = 90 Hz, 12 dB/oct.
SUBWOOFER (L.P.F)	fc = 90 Hz, 18 dB/oct.

VIDEO SECTION

Video Signal Type

PAL

Video Signal Level

1 Vp-p/75 ohms

S-Video Signal Level

Y	1 Vp-p/75 ohms
C	0.286 Vp-p/75 ohms

Maximum Input Level

1.5 Vp-p or more

Signal-to-Noise Ratio

50 dB or more

Monitor Out Frequency Response

.....	5 Hz to 10 MHz, -3 dB
-------	-----------------------

FM SECTION

Tuning Range

87.50 to 108.00 MHz

Usable Sensitivity (DIN)

Mono (S/N 26 dB)	0.9 µV
Stereo (S/N 46 dB)	28 µV

Selectivity

(two signals, 40 kHz Dev. ±300 kHz)	
.....	55 dB

Signal-to-Noise Ratio

(DIN-Weighted, 40 kHz Dev.)

Mono/Stereo	75 dB/69 dB
-------------------	-------------

Harmonic Distortion (1 kHz)

Mono/Stereo	0.1/0.2%
-------------------	----------

Stereo Separation (1 kHz)

48 dB

Frequency Response

20 Hz to 15 kHz	0±1 dB
-----------------------	--------

Antenna Input

75 ohms, Unbalanced

Output Level

(40 kHz Dev., 1 kHz)	550 mV
----------------------------	--------

AM SECTION

Tuning Range

531 to 1,611 kHz

Usable Sensitivity

300 µV/m

Signal-to-Noise Ratio

52 dB

Antenna

Loop antenna

Output Level

(30% mod., 1 kHz)	150 mV
-------------------------	--------

GENERAL

Power Supply

AC 230 V, 50 Hz

Power Consumption

300 W

AC Outlets

2 SWITCHED OUTLETS

[Europe model]

100 W max. total

1 SWITCHED OUTLET

[U.K. model]

100 W max.

Dimensions (W x H x D)

.....

435 x 151 x 391 mm

(17-1/8" x 5-15/16" x 15-3/8")

Weight

12.5 kg (27 lbs. 8 oz.)

Accessories

AM loop antenna

Indoor FM antenna

75-ohm/300-ohm antenna adapter

(U.K. model only)

Remote control

Batteries

Specifications are subject to change without notice.



YAMAHA ELECTRONICS CORPORATION, USA 6660 ORANGETHORPE AVE., BUENA PARK, CALIF. 90620, U.S.A.
YAMAHA CANADA MUSIC LTD. 135 MILNER AVE., SCARBOROUGH, ONTARIO M1S 3R1, CANADA
YAMAHA ELECTRONIK EUROPA G.m.b.H. SIEMENSSTR. 22-34, 25462 RELINGEN BEI HAMBURG, F.R. OF GERMANY
YAMAHA ELECTRONIQUE FRANCE S.A. RUE AMBROISE CROIZAT BP70 CROISSY-BEAUBOURG 77312 MARNE-LA-VALLEE CEDEX02, FRANCE
YAMAHA ELECTRONICS (UK) LTD. YAMAHA HOUSE, 200 RICKMANSWORTH ROAD WATFORD, HERTS WD1 7JS, ENGLAND
YAMAHA SCANDINAVIA A.B. J A WETTERGRENS GATA 1, BOX 30053, 400 43 VÄSTRA FRÖLUNDA, SWEDEN
YAMAHA MUSIC AUSTRALIA PTY, LTD. 17-33 MARKET ST., SOUTH MELBOURNE, 3205 VIC., AUSTRALIA

YAMAHA CORPORATION
Printed in Malaysia ID V403300

Quick Reference Card

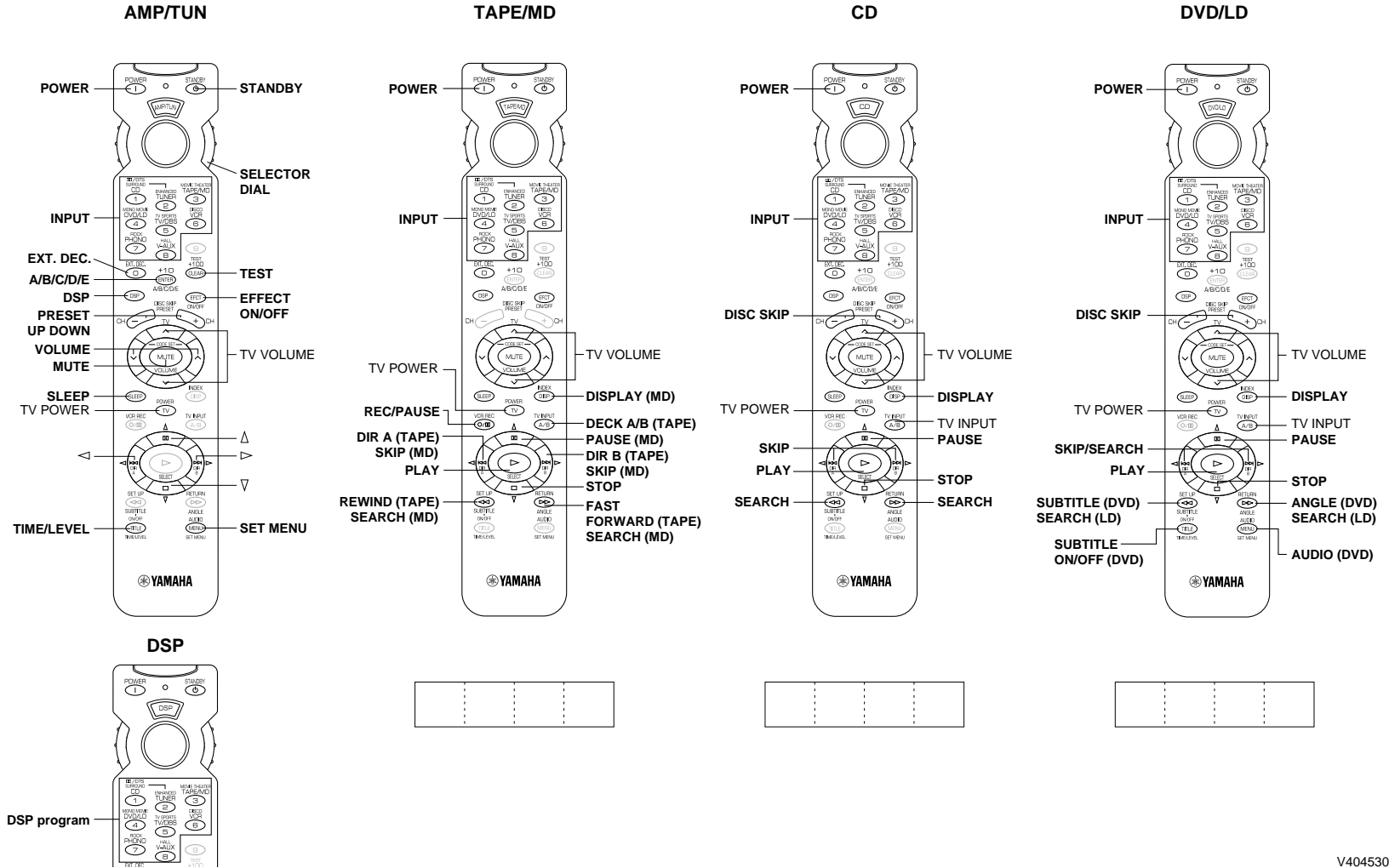

Quick Reference Card

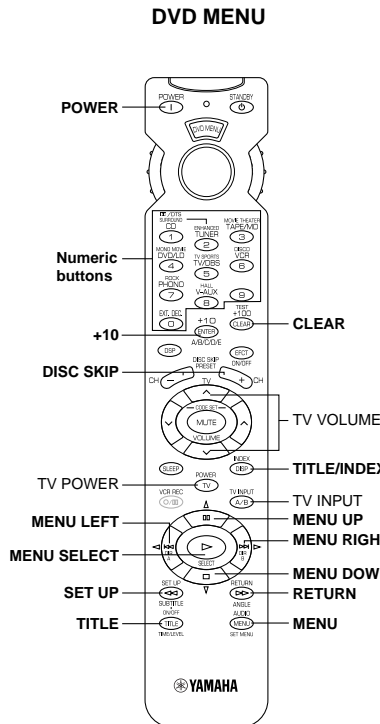
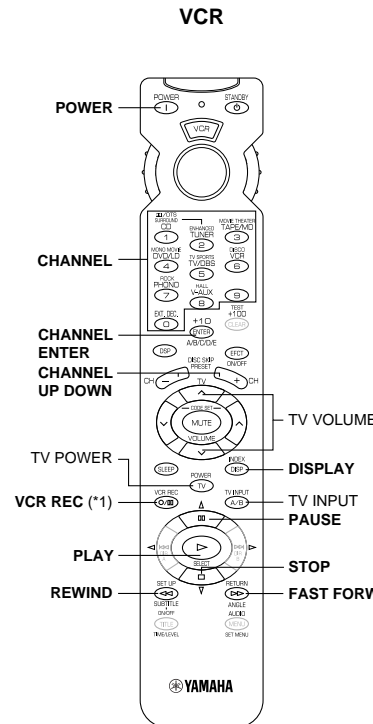
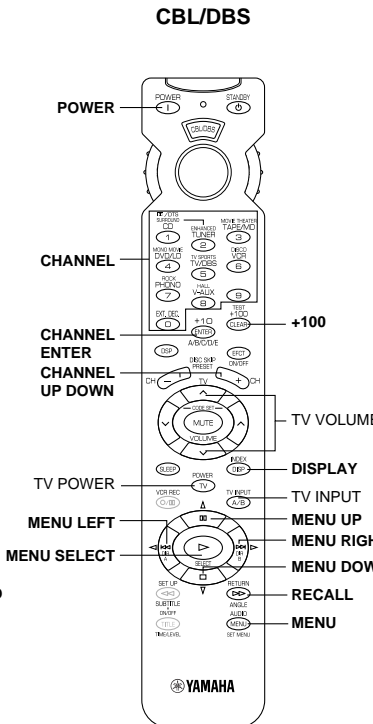
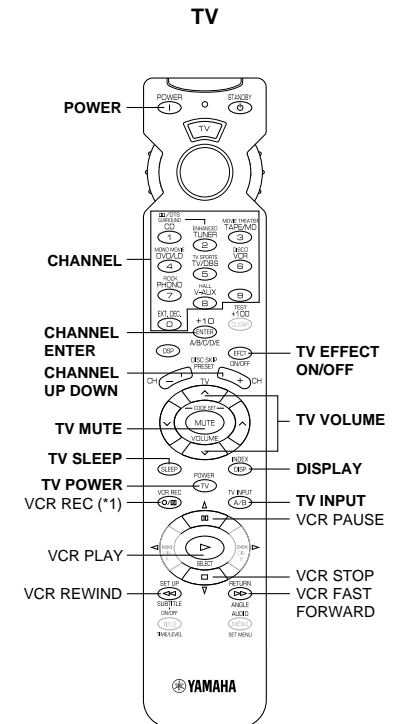
DVD MENU	VCR	CBL/DBS	TV
 <p>POWER -1 0</p> <p>Numeric buttons</p> <p>+10</p> <p>DISC SKIP</p> <p>TV VOLUME</p> <p>TV POWER</p> <p>MENU LEFT</p> <p>MENU SELECT</p> <p>SET UP</p> <p>TITLE</p> <p>YAMAHA</p>	 <p>POWER -1 0</p> <p>CHANNEL</p> <p>CHANNEL ENTER</p> <p>CHANNEL UP DOWN</p> <p>TV POWER</p> <p>VCR REC (*1)</p> <p>PLAY</p> <p>REWIND</p> <p>YAMAHA</p>	 <p>POWER -1 0</p> <p>CHANNEL</p> <p>CHANNEL ENTER</p> <p>CHANNEL UP DOWN</p> <p>TV POWER</p> <p>MENU LEFT</p> <p>MENU SELECT</p> <p>YAMAHA</p>	 <p>POWER -1 0</p> <p>CHANNEL</p> <p>CHANNEL ENTER</p> <p>CHANNEL UP DOWN</p> <p>TV MUTE</p> <p>TV SLEEP</p> <p>TV POWER</p> <p>VCR REC (*1)</p> <p>VCR PLAY</p> <p>VCR REWIND</p> <p>YAMAHA</p>
			<p>TV EFFECT ON/OFF</p> <p>TV VOLUME</p> <p>DISPLAY</p> <p>TV INPUT</p> <p>TV INPUT PAUSE</p> <p>TV INPUT</p> <p>MENU UP</p> <p>MENU RIGHT</p> <p>MENU DOWN</p> <p>RETURN</p> <p>MENU</p> <p>TV EFFECT ON/OFF</p> <p>TV VOLUME</p> <p>DISPLAY</p> <p>TV INPUT</p> <p>TV INPUT PAUSE</p> <p>TV INPUT</p> <p>MENU UP</p> <p>MENU RIGHT</p> <p>MENU DOWN</p> <p>VCR STOP</p> <p>VCR FAST FORWARD</p>

*1: Press this button twice to start recording.
 Appuyer deux fois sur cette touche pour démarrer l'enregistrement.
 Diese Taste zweimal drücken, um die Aufnahme zu starten.
 Tryck två gånger på denna knapp för att starta inspelningen.

Premere due volte questo tasto per iniziare la registrazione.
 Presione dos veces este botón para empezar a grabar.
 Druk tweemaal op deze toets om met opnemen te beginnen.
 按两次该按钮即可开始录像。