



**POCKET RECORDER**  
**POCKETRAK CX**  
**Reference Manual**

# Table of Contents

<b>Starting Up .....</b>	<b>4</b>	<b>Playback .....</b>	<b>26</b>
Part names and functions .....	4	Playing back files .....	26
Front, side and back panels .....	4	Playing back tracks from the Playlist .....	27
LCD screen .....	7	Indicators displayed during playback .....	27
About the screens .....	8	Fast forwarding and fast reversing .....	28
Navigating the list screen .....	8	Using headphones .....	28
Setting the current date and time .....	9		
<b>Recording .....</b>	<b>10</b>	<b>Playback Settings .....</b>	<b>29</b>
Before recording .....	10	Changing the playback speed .....	29
Attaching the wind screen (protection against wind and sibilance) .....	10	Playing back specific sections of a track .....	30
Selecting a Recording mode .....	10	Using the Skip playback function .....	30
Turning the ALC (Auto Level Control) function on or off .....	10	Using the A-B Repeat playback function .....	31
Setting the microphone sensitivity .....	10	Using the Phrase playback function .....	31
Using an external microphone .....	10	Playing back the same track repeatedly .....	32
Attaching the recorder to a tripod or a microphone stand .....	11	Playing back with less noise (Clear Voice) .....	33
Recording a musical performance .....	11	Setting the sound EQ (equalizer) (applicable only to the M and L folders) .....	34
Adjusting the recording level .....	12	About the sound EQ options .....	34
Simple recording (musical practice, meeting, etc.) .....	13	Selecting a sound EQ option .....	35
Recording from an external audio device (such as a CD player) .....	14	Customizing the sound EQ option .....	36
		<b>Editing Files .....</b>	<b>37</b>
<b>Recording Settings .....</b>	<b>16</b>	Dividing files .....	37
Changing the Recording mode (Selecting a sound quality) .....	16	Using the fade in and fade out effects .....	39
Changing Recording mode .....	17	Applying the fade in effect .....	39
Turning the ALC (Auto Level Control) on and off .....	17	Applying the fade out effect .....	40
Setting the recording EQ (equalizer) .....	18	Inserting and deleting index marks .....	40
About recording EQ options .....	18	Inserting index marks .....	40
Selecting a recording EQ option .....	19	Deleting index marks .....	40
Customizing the recording EQ .....	20		
Setting the recording peak limiter .....	21	<b>Deleting .....</b>	<b>42</b>
Setting the High Pass Filter (HPF) .....	21	Managing the Recycle Bin .....	42
Setting Stereo Wide recording .....	21	Activating the Recycle Bin function .....	42
VAS (Voice Activated System) recording .....	22	Displaying the Recycle Bin folder .....	42
Setting the voice sensing level (VAS value) .....	22	Playing back a file in the Recycle Bin folder .....	43
Setting the Auto Divide function (AUTO DIVIDE) .....	23	Restoring a file from the Recycle Bin folder .....	43
Recording with the self timer .....	24	Emptying the Recycle Bin folder .....	44
Changing the LED setting .....	25	Deleting a selected file .....	45
		Deleting all files from a folder .....	46
		Formatting a microSD card (Deleting all data) .....	46
		<b>Using the Timer Functions .....</b>	<b>47</b>
		Programming Timer recording .....	47
		Programming the alarm .....	48

<b>About the Menu Settings .....</b>	<b>50</b>	<b>Using the POCKETRAK CX as a Music Player .....</b>	<b>62</b>
Menu and menu item list .....	50	Ripping CDs (Creating compatible music files from music CDs) .....	62
Setting the menu options.....	51	Transferring music files to the POCKETRAK CX (Sync function) .....	64
<b>Selecting the battery type .....</b>	<b>51</b>	Playing back tracks in a specific sequence.....	66
<b>Turning the beep sound on or off.....</b>	<b>52</b>	Creating a Playlist.....	66
<b>Activating the Auto Power Off function.....</b>	<b>52</b>	<b>Importing Audio Files into Cubase AI .....</b>	<b>67</b>
<b>Setting the Backlight function.....</b>	<b>52</b>	<b>Recharging the eneloop .....</b>	<b>71</b>
<b>Adjusting the LCD contrast.....</b>	<b>53</b>	<b>Appendix .....</b>	<b>72</b>
<b>Initializing the menu settings.....</b>	<b>53</b>	Error messages .....	72
<b>Checking the firmware version.....</b>	<b>53</b>	Troubleshooting.....	74
<b>Using the POCKETRAK CX with a Computer.....</b>	<b>54</b>	FAQ.....	78
Computer system requirements .....	54	Specifications .....	80
Connecting the recorder to your computer...	54	Index.....	82
Disconnecting the recorder from your computer.....	55		
Troubleshooting (Windows Vista/XP).....	56		
About files and folders.....	57		
About the file naming rules .....	59		
Transferring audio files from the recorder to a computer.....	60		
Copying audio files to a CD-R.....	60		

### About the manuals

The operation of the POCKETRAK CX is explained in this Reference Manual (this file) and also in the Owner's Manual (printed version).

**Owner's Manual (printed version):** The Owner's Manual includes information about precautions, setup and basic operation that will get you started as easily as possible.

**Reference Manual (this file):** The Reference Manual includes part names and functions, detailed descriptions and procedures that will help you take full advantage of the POCKETRAK CX, and troubleshooting information.

### Copyrights

- Copying of the commercially available musical data is strictly prohibited except for your personal use.
- This Reference Manual is the exclusive copyrights of Yamaha Corporation.
- Windows is a registered trademark of Microsoft® Corporation in the United States and other countries.
- Apple, Mac and Macintosh are trademarks of Apple Inc., registered in the U.S. and other countries.
- Eneloop® is a registered trademark of SANYO Electric Co., Ltd.
- The microSD and microSDHC logos are trademarks.
- The company names and product names in this manual are the trademarks or registered trademarks of their respective companies.





\* The illustrations and LCD screens shown in this manual are for instructional purposes only and may appear somewhat different from those on your instrument.

# Starting Up

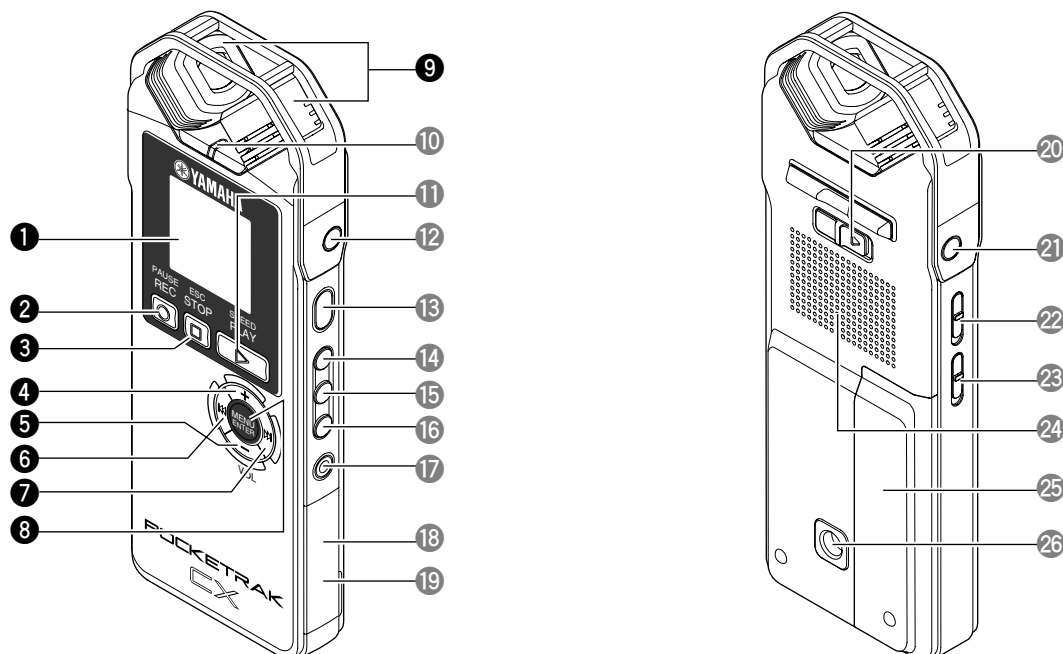
## Part names and functions

### Front, side and back panels



- ① **LCD screen**
- ② **[REC/PAUSE ] button**  
Starts or pauses recording.
- ③ **[STOP/ESC ] button**  
Stops recording or playback. Press this button during the menu setting operation to return to the previous screen or setting.
- ④ **[VOL +] button**  
Increases the volume of playback or recording monitoring. Also, it moves the cursor upward during menu operation or file selection.
- ⑤ **[VOL -] button**  
Decreases the volume of playback or recording monitoring. Also, it moves the cursor downward during menu operation or file selection.
- ⑥ **[] button**  
Fast reverse button. Also, use this button to return to the previous screen during the menu setting operation or while the list screen is displayed, move the cursor to the left, or set the recording level.
- ⑦ **[] button**  
Fast forward button. Also, use this button to proceed to the next screen during the menu setting operation or while the list screen is displayed, move the cursor to the right, or set the recording level.
- ⑧ **[MENU/ENTER] button**  
While the main screen is displayed, press and hold down this button for at least two (2) seconds to display the menu screen. During the menu setting operation or while the list screen is displayed, press this button once to confirm the item selection or the operation.
- ⑨ **Built-in stereo microphone**  
The recorder features a high-performance X-Y stereo microphone.

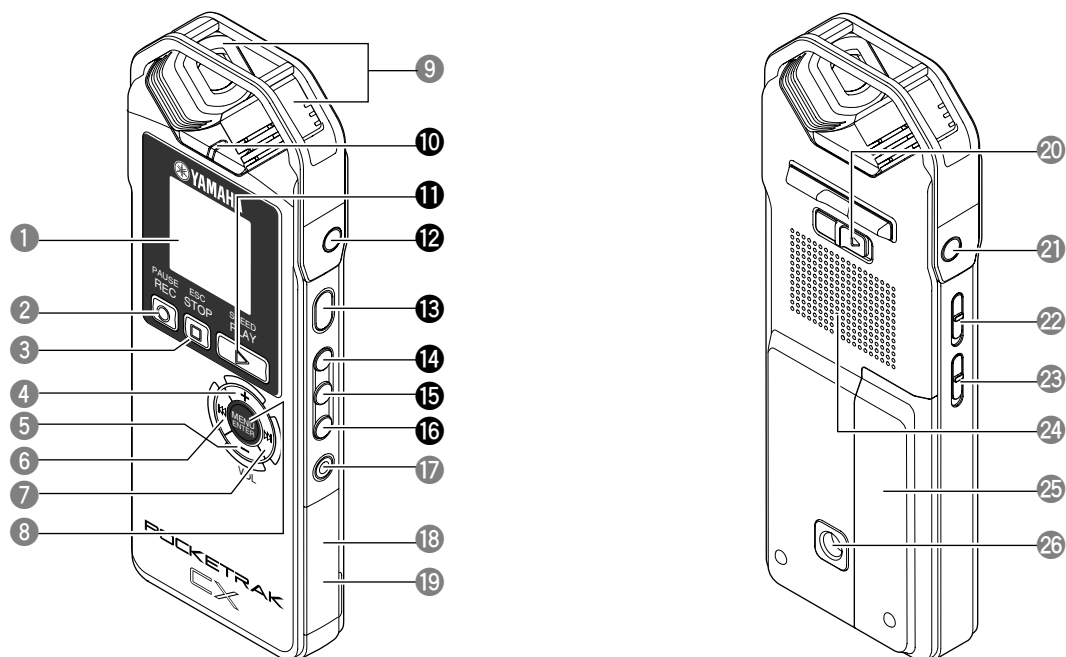

- 10 LED indicator**  
Lights up as a “recording or playback indicator” during recording or playback, as a “peak indicator” if the level of the recording input source is too high, and as a “charging indicator” while the battery is being charged.  
 ⓘ Changing the LED setting (page 25)
- 11 [PLAY/SPEED ▶ ] button**  
Starts playback or changes the playback speed in stages.  
 ⓘ Playback (page 26)  
 ⓘ Changing the playback speed (page 29)
- 12 MIC/LINE 🎤 socket**  
External stereo microphone/line level input socket. Select [MIC] for the [REC SELECT] menu item when you connect an external microphone. Select [LINE] when you connect and record from an external audio device.  
 ⓘ Using an external microphone (page 10)  
 ⓘ Recording from an external audio device (such as a CD player) (page 14)
- 13 [POWER] button**  
Turns the power to the POKKETRAK CX on or off. Press the button once briefly to turn the power on. Press and hold down the button for at least two (2) seconds to turn the power off.
- 14 [FOLDER/A-B REPEAT] button**  
Press this button to select a folder or to use the A-B Repeat or Clear Voice function.
- 15 [LIST/INDEX] button**  
To display a list of files in the selected folder, press this button while the recorder is stopped.  
Press this button during recording or playback to insert index marks (playback position locators).  
 ⓘ Inserting index marks (page 40)
- 16 [EDIT/PHRASE] button**  
Use this button to edit a file. Alternatively, use this button to perform Phrase playback (the playback point will be moved back by the specified number of seconds).  
 ⓘ Editing Files (page 37)  
 ⓘ Using the Phrase playback function (page 31)

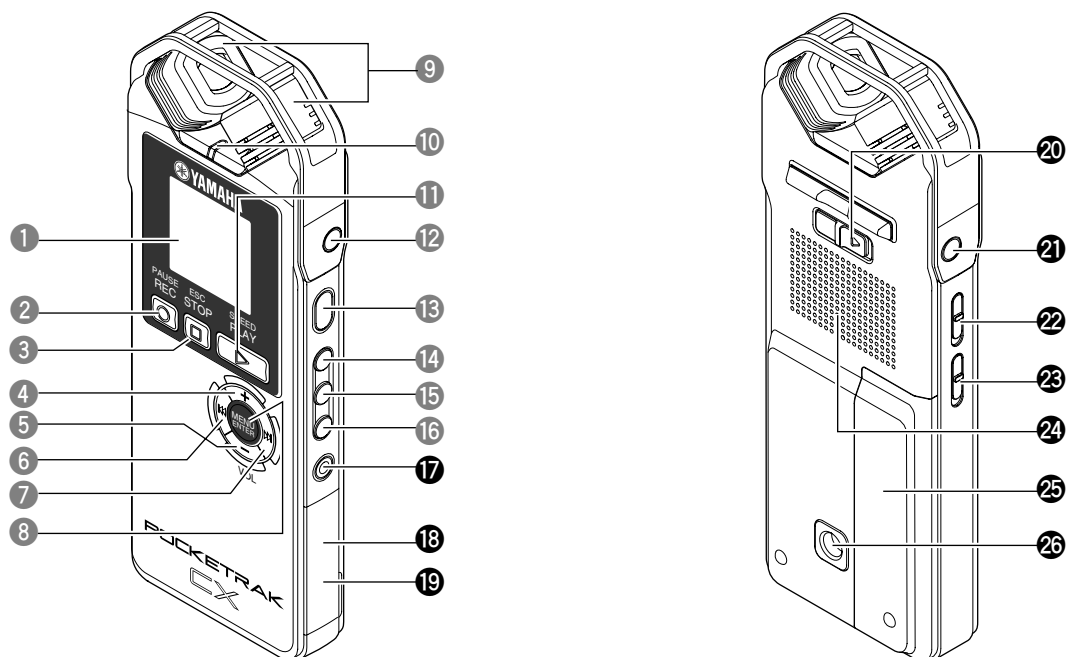

- 17 [DEL] button**  
Deletes files, folders, or index marks. It also recalls the Recycle Bin menu while the Recycle Bin folder is selected.  
[▶▶▶ Deleting \(page 42\)](#)
- 18 microSD card slot**  
Insert a microSD card here.
- 19 USB terminal**  
Connect this terminal to a computer using the included USB cable.
- 20 [HOLD/CHARGE] switch**  
To engage the Hold function (to avoid accidental operation), slide the switch in the direction of the arrow.  
To start recharging the eneloop battery, slide the switch in the direction of the arrow after you connect the recorder to a computer.  
[▶▶▶ Recharging the eneloop \(page 71\)](#)
- 21 Headphones socket**  
Connect inner-ear headphones or other types of headphones here.
- 22 [ALC ON/OFF] switch**  
Set this switch to ON to automatically adjust the recording level in accordance with the source level to optimize the dynamics of the resulting recording.  
[▶▶▶ Turning the ALC \(Auto Level Control\) on and off \(page 17\)](#)
- 23 [MIC SENS HIGH/LOW] switch**  
Switches the microphone sensitivity to high or low in accordance with the recording environment.
- 24 Speaker**
- 25 Battery cover**
- 26 Threaded socket for attaching a tripod or a microphone stand adapter**  
Use this socket to attach a tripod or a microphone stand adapter.  
[▶▶▶ Attaching the recorder to a tripod or a microphone stand \(page 11\)](#)  
[▶▶▶ Page 9 of the included Owner's Manual](#)

## LCD screen

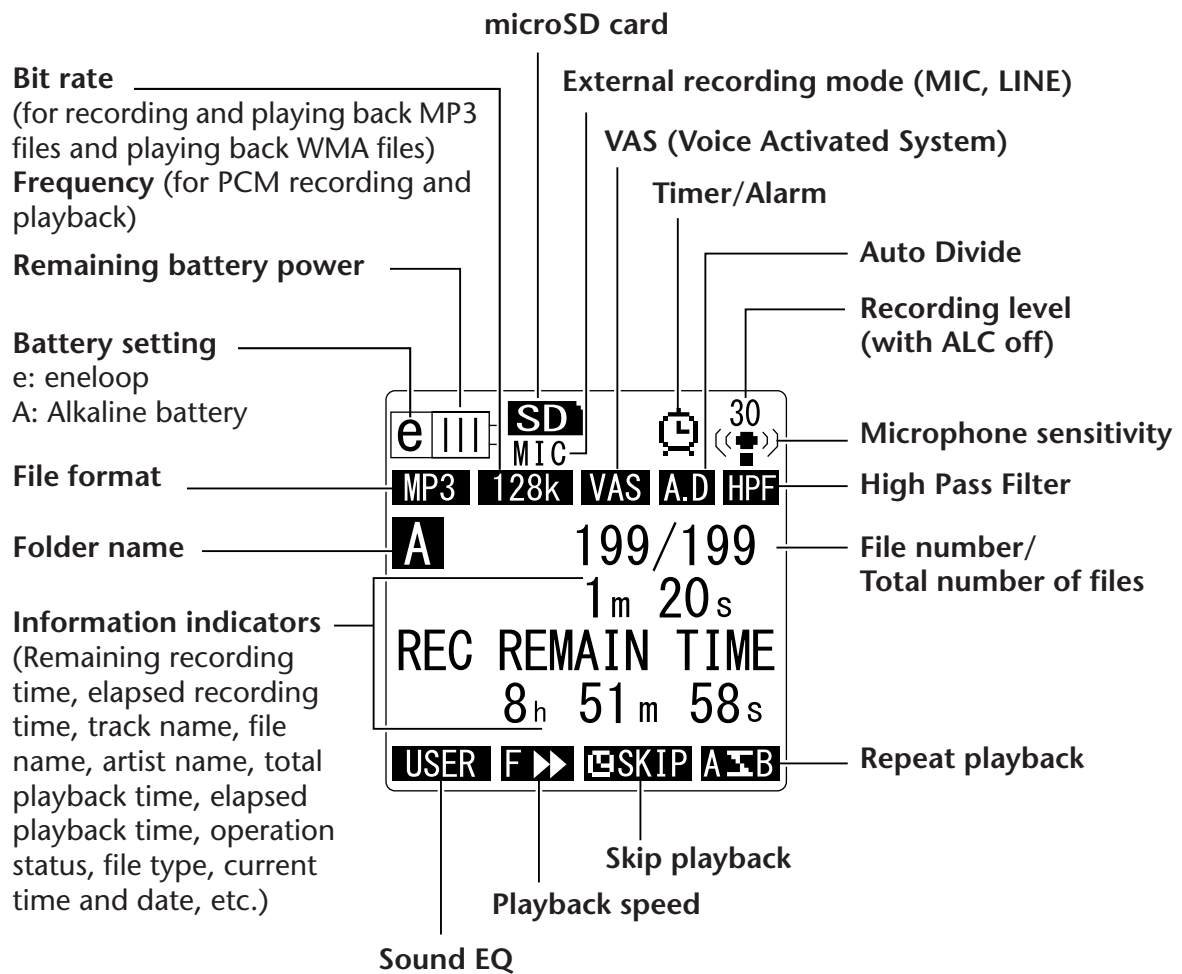

### Hint:

#### What is Linear PCM (Pulse Code Modulation) recording?

Linear PCM (LPCM) recording is a digital recording method that samples analog audio signals at a certain frequency and saves them as digital signals without compression.

Music CDs (CD-DA – CD digital Audio) use PCM recording (sampling rate of 44.1 kHz, bit depth of 16-bit samples, bit rate of 1,411 kbps, and frequency response from 20 to 20 kHz).

PCM recordings are digitally-recorded unprocessed audio, and are supposed to be of the highest sound quality. "WAVE" format is used to import these PCM recording files into a computer. The WAVE file extension is ".WAV". MP3 and WMA format files are created by compressing the LPCM data.

## About the screens

**[Main screen]**

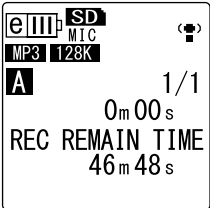

Appears when the power to the unit is turned on.

**[Menu screen]**



Appears when you press and hold down the [MENU/ENTER] button for at least two (2) seconds while the main screen is displayed. This screen enables you to change Recording mode, set the date and time, initialize the recorder, and make various other settings.

**[List screen]**

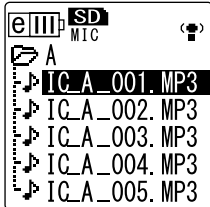

Appears when you press the [LIST/INDEX] button while the main screen is displayed. The files stored on the microSD card will be displayed in a tree structure.

**Hint:**

- To go back to the main screen, press the [STOP/ESC □] button.
- Press the [STOP/ESC □] button repeatedly to select one of the indicators for the file in the following order (if the playback file exists).  
[REC REMAIN TIME]→[DATE & TIME]→[TOTAL TIME]→[REC DATE & TIME]

## Navigating the list screen

This section explains how to select a file from the list screen and play it back.

1. Press the [LIST/INDEX] button while the main screen is displayed and the recorder is stopped.  
The recorder displays the list screen.
2. Press the [VOL +/-] buttons to select the file you wish to play.

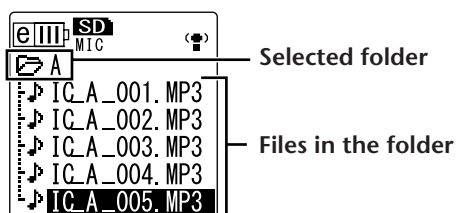

To select a different folder, press the [◀◀]/[▶▶] buttons, or the [FOLDER/A-B REPEAT] button repeatedly to scroll through the folders.

**Hint:**

- For more information on the folders, refer to “Folder structure” on [page 59](#).

3. Press the [PLAY/SPEED ▶] button.  
The recorder starts to play the file.
4. Press the [STOP/ESC □] button.  
The recorder stops playback.



## Setting the current date and time

After you set the date and time, the POCKETRAK CX will automatically record the recording date and time with each file.

1. Press the [MENU/ENTER] button for at least two (2) seconds while the main screen is displayed, press the [VOL +/-] buttons to select [COMMON MENU], then press the [MENU/ENTER] button.

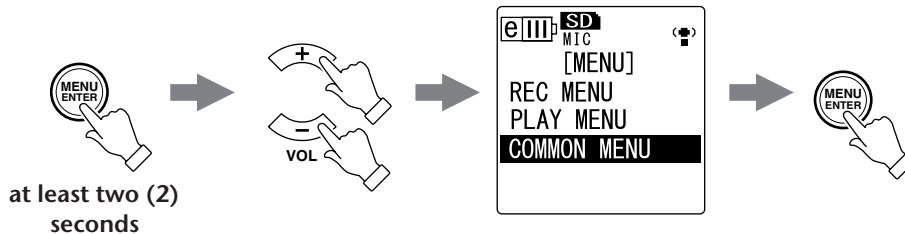

2. Press the [VOL +/-] buttons to select [DATE & TIME], then press the [MENU/ENTER] button.

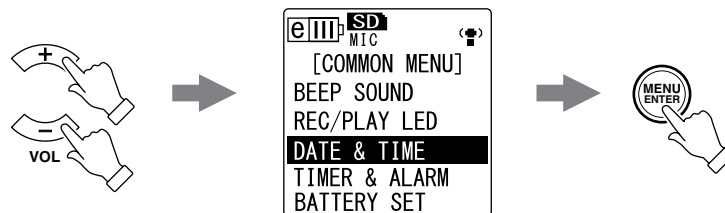

3. Press the [VOL +/-] buttons to select the year, then press the [▶▶] button.

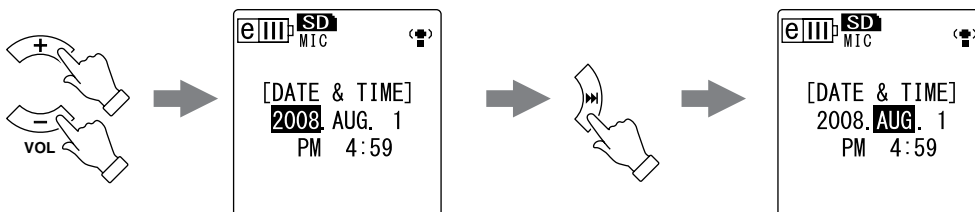

4. In the same way, select the month, day, 24/12-hour indication (24H or AM/PM), hour and minute, then press the [MENU/ENTER] button.

5. Press the [STOP/ESC] button twice.  
The recorder displays the main screen.

# Recording

## Before recording

### Attaching the wind screen (protection against wind and sibilance)

The built-in stereo microphone is highly sensitive. Therefore, a slight breeze or breath — even a weak air conditioning breeze that hits the microphones directly — will be recorded as noise. To reduce the level of wind and other environmental noise, Yamaha recommends that you use the recorder with the wind screen attached to the microphones. Also, to further minimize the noise level, Yamaha recommends that you turn on the High Pass Filter via menu item [HPF] (see [page 21](#)).

### Selecting a Recording mode

The POCKETRAK CX records audio in the MP3 or PCM (WAV) format. As a rule of thumb, select “PCM 44.1 kHz” (better sound quality) for Recording mode to record a musical performance. Select “MP3 128kbps” (smaller data size) to record musical practice sessions or conference meetings (see [page 16](#)).

### Turning the ALC (Auto Level Control) function on or off

Auto Level Control function automatically adjusts the recording level in response to the input source level to optimize the dynamics of the resulting recording (see [page 17](#)).

	ALC OFF	ALC ON
<b>Feature</b>	The recording will accurately represent the original sound and maintain the original sound dynamics.	The recording dynamics will be adjusted. Louder sounds will be quieter and softer sounds will be louder. This setting will reduce distortion and is better for dictation.
<b>Application</b>	Musical performance and nature recordings	Musical practice, conference meeting and interview recordings

### Setting the microphone sensitivity

You can set the microphone sensitivity level to high or low to accommodate the input volume. If the volume level is too high, set the [MIC SENS] (microphone sensitivity) switch on the left side of the unit to [LOW]. If the volume level is too low, set the switch to [HIGH].

### Using an external microphone

You can use an external microphone for recording, instead of using the built-in stereo microphone.

Select [MIC] for menu item [REC SELECT], then connect an external microphone to the MIC/LINE socket located on the right side of the unit.

Yamaha recommends that you use a microphone with the following specifications as an external microphone.

<b>Type</b>	Electret condenser microphone that features plug-in power operation
<b>Impedance</b>	2kΩ
<b>Power</b>	Guaranteed operation at 1.3V
<b>Plug</b>	Mini plug (3.5mm)

## Attaching the recorder to a tripod or a microphone stand

You can attach the recorder to a commercially-available camera or camcorder tripod using the threaded socket on the unit. You can also attach the recorder to a microphone stand using the included microphone stand adapter. In this way, you can set up the recorder in the optimum position. This can be useful for recording musical performances. (Please refer to page 9 of the included Owner's Manual.)

## Recording a musical performance

Before recording, set the [ALC] switch to [OFF] and the [MIC SENS] (microphone sensitivity) switch to [LOW].

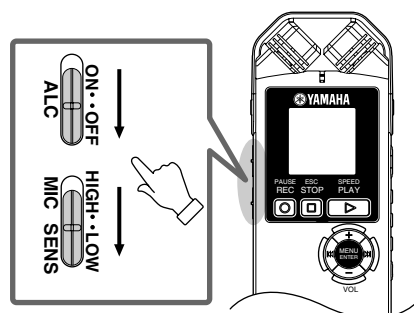

1. Press the [FOLDER/A-B REPEAT] button located on the side panel repeatedly to select a folder into which to record.

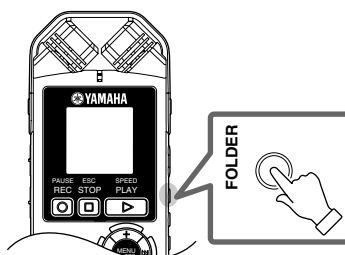

### Hint:

- Pressing the [FOLDER/A-B REPEAT] button repeatedly will scroll through the folders. Select a folder from folders A-D.

2. Press the [REC/PAUSE] button.

The unit enters recording [STANDBY] mode. (Recording has not yet started.)

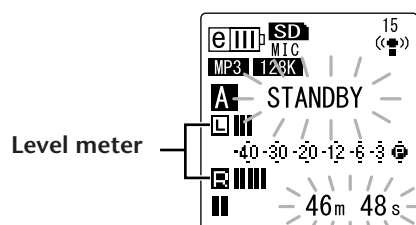

### Note:

- The level meter will move left or right in response to the sound level from the microphone.

- Press the [◀◀]/[▶▶] buttons to adjust the MIC LEVEL (recording level).  
Adjust the recording level while playing music, speaking, etc.

**Note:****Setting the recording peak limiter**

When the recording peak limiter is set to ON, the recorder reduces sound distortion by automatically adjusting excessive peaks. It is recommended that you set the limiter to ON when you are recording audio.

To set the recording peak limiter to ON, press and hold down the [MENU/ENTER] button for at least two seconds, then select [REC MENU] → [REC LIMITER] → [ON].

The peak limiter is available only when the ALC is set to OFF.

**Adjusting the recording level**

- Setting an appropriate recording level**

Adjust the recording level so that at the loudest source volume the level meter will move as far to the right as possible without deflecting all the way (and the recording LED will not turn off).

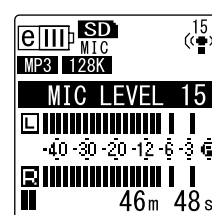

- If the recording level is too low:**

Press the [▶▶] button to adjust the recording level so that the level meter will move moderately to the right.

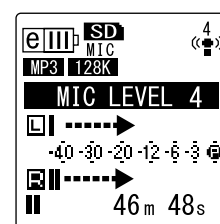
**Note:**

- If an appropriate recording level cannot be achieved even if you raise the level to "40," slide the [MIC SENS] switch to [HIGH].

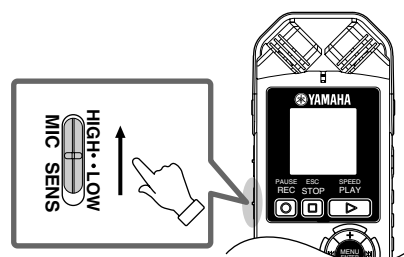

- If the recording level is too high:**

The level meter frequently moves all the way to the right and the recording LED turns off. The **PEAK** indicator appears on the screen.

Press the [◀◀] button to lower the recording level.

- Press the [REC/PAUSE Ⓞ] button again.

The LED lights up in red and recording begins.

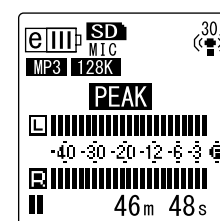

- Indicators displayed during recording

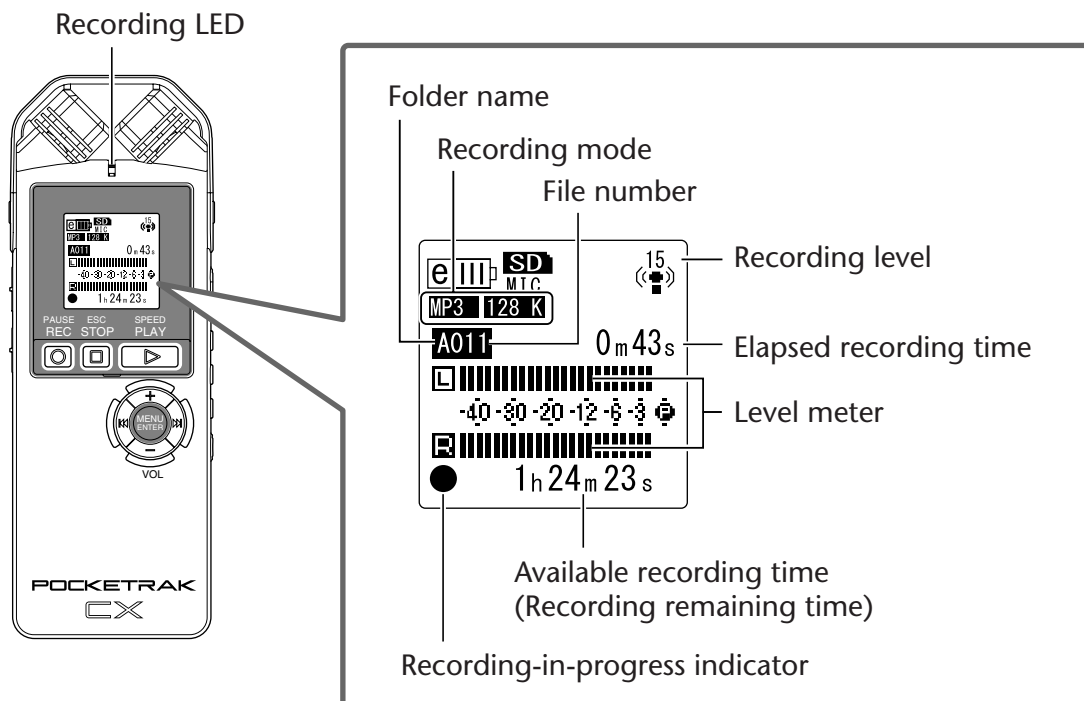

5. Press the [STOP/ESC ] button to stop recording.

The LED will turn off, and the REC REMAIN TIME indicator will be displayed on the screen.

## Simple recording (musical practice, meeting, etc.)

Before recording, set the [ALC] switch to [ON] and the [MIC SENS] (microphone sensitivity) switch to [HIGH].

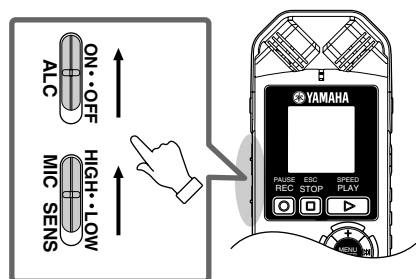

1. Press the [FOLDER/A-B REPEAT] button located on the side panel repeatedly to select a folder into which to record.

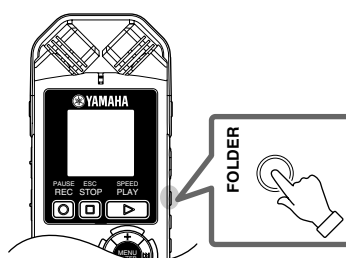

 **Hint:**

- Pressing the [FOLDER/A-B REPEAT] button repeatedly will scroll through the folders. Select a folder from folders A-D.

2. Press the [REC/PAUSE ] button.  
The LED lights up in red and recording begins.

**Hint:**

- If the recording level is too high (see page 12), set the [MIC SENS] (microphone sensitivity) switch to [LOW].

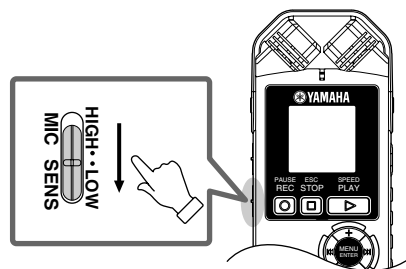

3. Press the [STOP/ESC ] button to stop recording.  
The LED will turn off and the REC REMAIN TIME indicator will be displayed on the screen.

## Recording from an external audio device (such as a CD player)

You can record line input sources from an external audio device (such as a CD player or MD player).

1. Press the [MENU/ENTER] button for at least two (2) seconds while the main screen is displayed, press the [VOL +/-] buttons to select [REC MENU] → [REC SELECT], then press the [MENU/ENTER] button.
2. Press the [VOL +/-] buttons to select [LINE], then press the [MENU/ENTER] button.

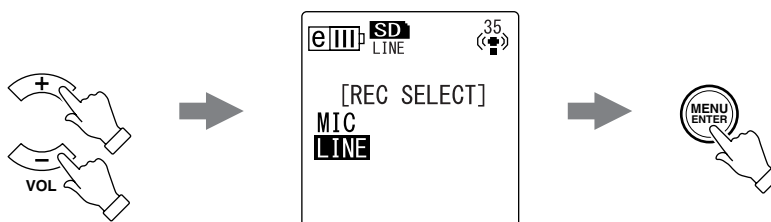

**Note:**

- Please note that you cannot adjust the recording level on the unit if [LINE] has been selected.

3. Connect the recorder's [MIC/LINE] socket to the audio output connector on the external device.

Use a commercially-available audio cable (stereo mini plug, 3.5mm, with no resistance).

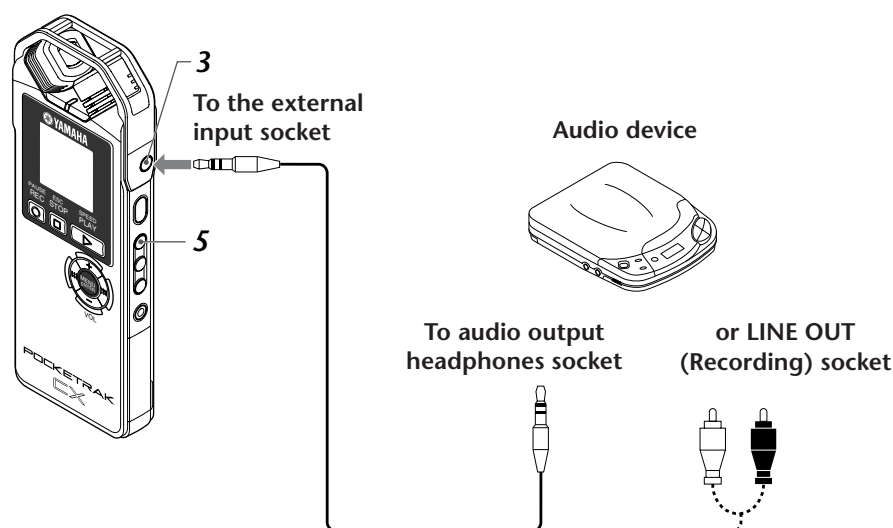

**4. Adjust the volume level of the external audio device while playing the recording source.**

**Hint:**

- Try a test recording to find an appropriate recording level.

**5. Press the [FOLDER/A-B REPEAT] button to select the “L” folder.**

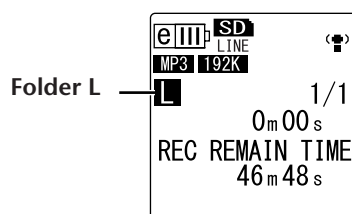

**Note:**

- The ALC function is automatically turned off during recording to the “L” folder.

**6. Play the recording source on the external audio device and press the [REC/PAUSE ] button.**  
Recording starts.

**Note:**

- A recording mode of “MP3:192kbps” will be selected automatically. You cannot select any other mode option.
- While you are recording audio through the line input from the connected external device, no audio will be heard from the speaker. Use the headphones to listen to the audio being recorded.

**7. Press the [STOP/ESC ] button to stop recording.**  
Stop playback on the external device.

# Recording Settings

## Changing the Recording mode (Selecting a sound quality)

The POCKETRAK CX enables you to record audio in MP3 or PCM (WAV) format. In PCM mode, non-compressed audio data will be recorded. In MP3 mode, compressed audio data will be recorded. With the better sound quality, the data size will be larger and available recording time will be shorter. Refer to the table below to select a Recording mode that will suit your purpose.

### Recording mode and application examples

Recording format	Sampling frequency or bit rate	File extension	Application examples	
PCM	48 kHz	.WAV	Recording a musical performance, creating a master recording, creating a CD, and recording other original sound sources	Higher sound quality ↑
	44.1 kHz			
MP3	320 kbps	.MP3	High-quality recording of musical practice sessions, conference meetings, etc. compressed into a smaller size file	Standard sound quality
	192 kbps			
	128 kbps			
	64 kbps		Recordings for which extended duration is more important than sound quality ("32kbps" indicates a monaural recording.)	↓ Longer recording time
	32 kbps			

### Available recording time (with the included microSD card)

Recording mode	Available recording time (estimated)
PCM 48 kHz	About 2 hours 50 minutes
PCM 44.1 kHz	About 3 hours 5 minutes
MP3 320 kbps	About 13 hours 35 minutes
MP3 192 kbps	About 22 hours 45 minutes
MP3 128 kbps	About 34 hours 5 minutes
MP3 64 kbps	About 68 hours 15 minutes
MP3 32 kbps	About 136 hours 30 minutes

- If you record multiple files, the total available recording time will be shorter than the times estimated above.
- If you are using a 2GB or larger microSD card, the largest available recording space (for continuous recording in one file) is 2GB.



## Changing Recording mode

1. Press the [MENU/ENTER] button for at least two (2) seconds while the main screen is displayed, press the [VOL +/-] buttons to select [REC MENU] → [REC MODE], then press the [MENU/ENTER] button.
2. Press the [VOL +/-] buttons to select the desired Recording mode option, then press the [MENU/ENTER] button.

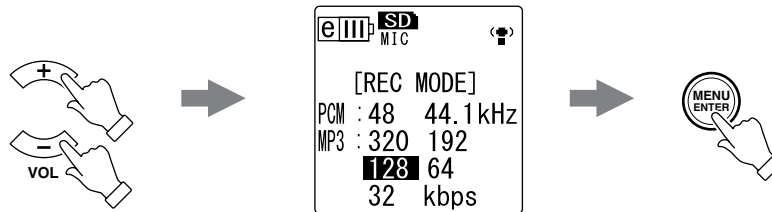

3. Press the [STOP/ESC □] button twice.  
The recorder displays the main screen.



## Turning the ALC (Auto Level Control) on and off

### Note:

- You can turn the ALC function on or off when recording audio to folders A – D.

#### • Turning the ALC function on

Slide the [ALC] switch located on the side panel of the unit to “ON.”  
The recording level will automatically be adjusted in response to the input level.

#### ALC ON

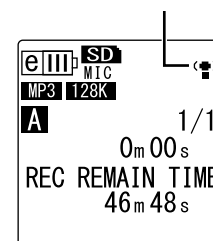

#### • Turning the ALC function off

Slide the [ALC] switch (located on the side panel of the unit) to “OFF.”  
You can change the recording level in increments (see [page 12](#)).

#### ALC OFF

(The recording level will be displayed.)

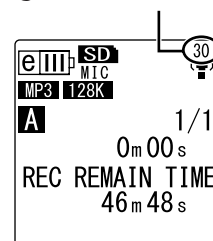

### Note:

- You cannot adjust the recording level when you are recording audio from a connected external device (see [page 14](#)).

## Setting the recording EQ (equalizer)

Setting the recording EQ enables to record the audio of the desired tonal quality by boosting the lower or higher frequency ranges.

You can use the recording EQ only when recording audio to folders A – D and when the ALC function is turned off.

### About recording EQ options

The POCKETRAK CX offers eight recording EQ presets and one USER recording EQ option (that enables you to customize by cutting and boosting five EQ bands individually). The recording EQ presets include RECOMMENDED, FLAT, SUPER BASS, BASS, MIDDLE, BASS&TREBLE, TREBLE, and SUPER TREBLE.

#### Features of each recording EQ preset

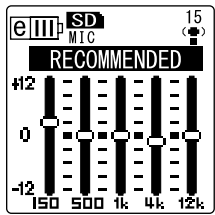
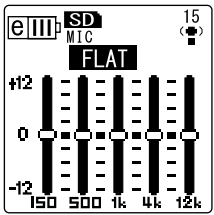
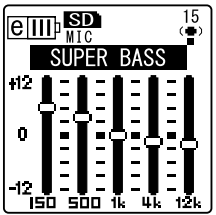
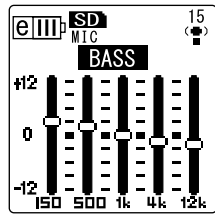
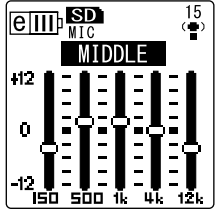
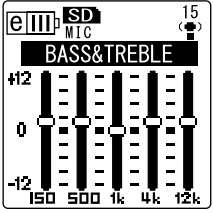
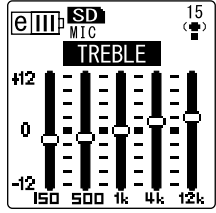
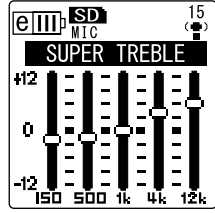
RECOMMENDED	FLAT	SUPER BASS	BASS
			
This preset is recommended for recording via the built-in microphone.	No EQ is used for recording.	This preset significantly boosts the lower frequency range.	This preset mildly boosts the lower frequency range.
MIDDLE	BASS&TREBLE	TREBLE	SUPER TREBLE
			
This preset boosts the mid frequency range.	This preset mildly boosts the lower and higher frequency ranges.	This preset mildly boosts the higher frequency range.	This preset significantly boosts the higher frequency range.

#### Note:

- You cannot change the parameters of these eight recording EQ presets. Select the USER recording EQ option if you wish to customize the recording EQ.

## Selecting a recording EQ option

1. Set the [ALC] switch to "OFF."
2. Press the [FOLDER/A-B REPEAT] button repeatedly to select a folder into which to record.  
Select a folder from folders A-D.
3. Press the [REC/PAUSE ] button.  
The unit displays the [STANDBY] indicator.

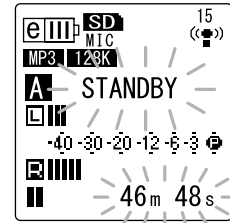

4. Press and hold down the [MENU/ENTER] button for at least two (2) seconds while the [STANDBY] indicator is displayed.  
The unit displays the recording EQ screen.
5. Press the [◀◀]/[▶▶] buttons to select the desired recording EQ option.  
You can select from eight recording EQ presets and one USER recording EQ (which enables you to customize the EQ settings).

### Hint:

- For information on how to customize the USER recording EQ option, refer to "Customizing the recording EQ" on [page 20](#).

6. Press the [MENU/ENTER] button.  
The selection of the recording EQ is confirmed. Adjust the recording level, then press the [REC/PAUSE ] button again to start recording (see [page 12](#)).

### Note:

- To cancel the operation, press the [STOP/ESC ] button.

## Customizing the recording EQ

The USER recording EQ enables you to customize the level of five EQ bands.

1. Select "USER" while the recording EQ screen is displayed.

Refer to steps 1-5 in the "Selecting a recording EQ option" section on [page 19](#).

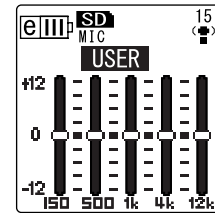

2. Press the [VOL -] button.

The 150Hz band will be selected and displayed as a black bar.

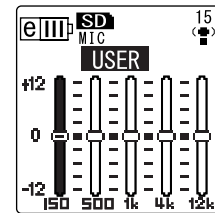

3. Press the [◀◀]/[▶▶] buttons to select a frequency band that you wish to cut or boost.

The selected frequency band will be displayed as a black bar.

4. Press the [VOL +/-] buttons to boost or cut the level of the selected frequency band.

You can boost the level by as much as +12dB or cut the level by as much as -12dB in 1dB steps. The larger value will raise the recording level and boost the frequency band.

### Note:

- To adjust the level of other frequency bands, repeat steps 3 and 4.
- To cancel the operation, press the [STOP/ESC □] button.

5. Press the [MENU/ENTER] button.

The USER recording EQ is now customized. Adjust the recording level, then press the [REC/PAUSE ○] button again to start recording (see [page 12](#)).

### Note:

- The USER recording EQ setting is retained when you turn the power off or change the battery. However, the setting will be lost if you change the battery without first turning the power off.

## Setting the recording peak limiter

When the recording peak limiter is set to ON, the recorder reduces sound distortion by automatically adjusting excessive peaks. It is recommended that you set the limiter to ON when you are recording audio. The peak limiter is available only when the ALC is set to OFF.

### Procedure:

Press the [MENU/ENTER] button for at least two (2) seconds while the main screen is displayed, select [REC MENU] → [REC LIMITER] → [ON], then press the [MENU/ENTER] button.  
To cancel the recording peak limiter, select [OFF].

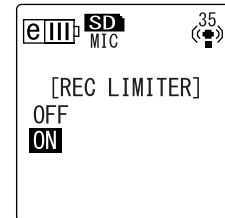

## Setting the High Pass Filter (HPF)

You can cut the low frequency range by switching the High Pass Filter on. The filter reduces the level of chatting voices, wind and other noise in the recording environment and enables you to record clearer audio.

### Procedure:

Press the [MENU/ENTER] button for at least two (2) seconds while the main screen is displayed, select [REC MENU] → [HPF (High Pass Filter)] → [ON], then press the [MENU/ENTER] button.  
To cancel the High Pass Filter, select [OFF].

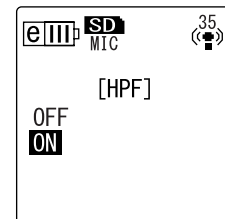

## Setting Stereo Wide recording

Recording with the STEREO WIDE option set to ON will enhance and widen the stereo image of the recorded sound.

### Procedure:

Press the [MENU/ENTER] button for at least two (2) seconds while the main screen is displayed, select [REC MENU] → [STEREO WIDE] → [ON], then press the [MENU/ENTER] button.  
To cancel the stereo wide setting, select [OFF].

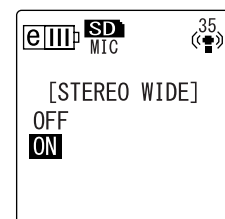

## VAS (Voice Activated System) recording

When the VAS recording function is turned on, if the unit is in recording pause mode, the unit will automatically start to record as soon as it detects audio at a level above a certain threshold. The unit will pause recording when the detected audio level falls below the threshold. VAS recording is available only when ALC is set to ON.

### Note:

- Audio at a level below a certain threshold will be undetected and will not be recorded. If you are planning to record important audio, set the VAS recording to OFF.

1. Press the [MENU/ENTER] button for at least two (2) seconds while the main screen is displayed, select [REC MENU] → [VAS] → [ON], then press the [MENU/ENTER] button.

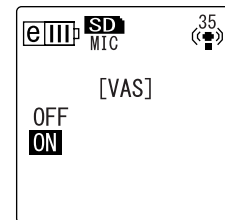

2. Press the [STOP/ESC] button twice. "VAS" will appear on the main screen.

3. Press the [REC/PAUSE] button.

As soon as the unit detects audio, recording begins. If the unit does not detect any audio, the elapsed recording time indicator and the VAS indicator will flash, and the unit will enter Recording Pause mode.

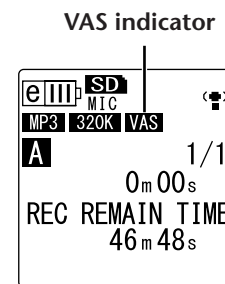

### Note:

- If the recorder does not detect any audio or does not pause recording, adjust the threshold by following the procedure in the "Setting the voice sensing level (VAS value)" section below.
- If you start recording while the VAS function is turned on, the first two seconds or so will be recorded with no exception.

## Setting the voice sensing level (VAS value)

You can adjust the voice sensing level in five steps (1-5) to accommodate the source volume level. A larger value will increase the voice activation sensitivity so recording will be triggered by lower-level audio. If the value is too small, the recorder may not detect audio. Set the microphone sensitivity (see page 10) in accordance with the source input level so that the VAS function can work more effectively.

### Procedure:

To adjust the voice sensing level, press the [◀◀]/[▶▶] buttons while recording with the VAS function turned on.

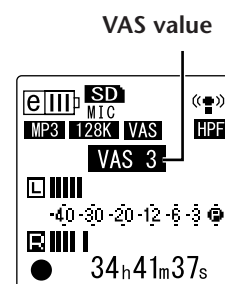

### Note:

- If the High Pass Filter is turned on, the filter will cut the low range, and recording may not start. In this case, set the VAS function to Off.

## Setting the Auto Divide function (AUTO DIVIDE)

If you turn the Auto Divide function on when recording a line source, such as tracks from a CD player, the unit automatically detects a silent pause between tracks and records each track as an individual file. More specifically, when the recorder detects a silent pause of two seconds or longer, it pauses recording, thus storing the audio data up to the silent pause as one file. In this way, the unit will record the first track as file 1, the second track as file 2, and so on.

1. Press the [MENU/ENTER] button for at least two (2) seconds while the main screen is displayed, select [REC MENU] → [AUTO DIVIDE] → [ON], then press the [MENU/ENTER] button.

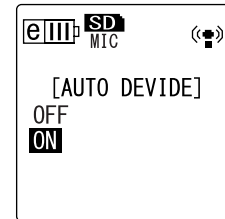

2. Press the [STOP/ESC] button twice.

The unit displays the main screen, including the **A.D** (Auto Divide) indicator.

To cancel the Auto Divide function, select [OFF] in step 1.

Auto Divide indicator

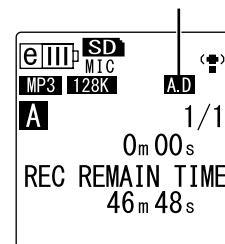

### Note:

- The function will not work if the recorder does not detect a silence of two seconds between tracks on a live CD or similar source. In this case, use the Divide File function (see page 37) to manually divide the files.
- If the unit detects silence for 15 seconds or more, recording stops automatically.

## Recording with the self timer



You can specify the time duration from the press of the [REC/PAUSE ] button until the start of recording. This function is useful when you need some time to prepare. For example, you may wish to practice your musical instrument until the actual recording starts.

1. Press the [MENU/ENTER] button for at least two (2) seconds while the main screen is displayed, select [REC MENU] → [SELF TIMER], then press the [MENU/ENTER] button.

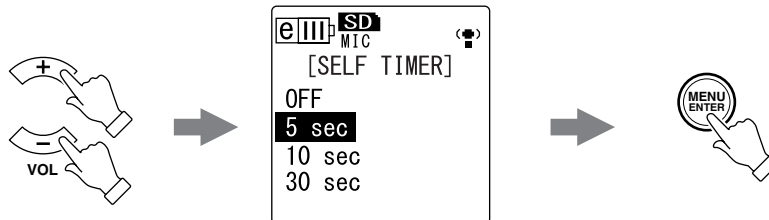

2. Press the [VOL +/-] buttons to select a self timer value of 5, 10 or 30 seconds, then press the [MENU/ENTER] button.



3. Press the [STOP/ESC ] button twice.  
The recorder displays the main screen.
4. Press the [FOLDER/A-B REPEAT] button located on the side panel repeatedly to select a folder into which to record.
5. Press the [REC/PAUSE ] button.  
The recorder displays the self timer standby screen, then starts counting down for the duration specified in step 2. (The LED indicator flashes.)

### Note:

- If the [ALC] switch is set to OFF, the unit enters recording standby mode. Adjust the recording level, then press the [REC/PAUSE ] button again.

6. After the time specified in step 2 expires, recording begins.

### Note:

- Once self timer recording begins, the self timer recording setting turns off automatically.

### Hint:

- To cancel self timer recording, press the [STOP/ESC ] button during countdown.



## Changing the LED setting

During recording or playback, the LED indicator lights up in red or green by default (the REC/PLAY option). However, you can set the LED indicator so that it will *not* light up during recording or playback (the OFF option). Alternatively, you can set the indicator to function as a recording peak LED (the PEAK/PLAY option), in which case the LED indicator will light up in red during excessive peaks.

1. Press the [MENU/ENTER] button for at least two (2) seconds while the main screen is displayed, select [COMMON MENU] → [REC/PLAY LED], then press the [MENU/ENTER] button.



2. Press the [VOL +/-] buttons to select [OFF], [REC/PLAY] or [PEAK/PLAY], then press the [MENU/ENTER] button.



[OFF]	The LED indicator remains off during recording and playback.
[REC/PLAY]	The LED indicator lights up in red during recording and in green during playback. It turns off during excessive recording peaks.
[PEAK/PLAY]	The LED indicator lights up in red during excessive recording peaks. The LED indicator is off during normal recording. The LED indicator lights up in green during playback.

3. Press the [STOP/ESC □ ] button twice.  
The recorder displays the main screen.

# Playback

## Playing back files

The POCKETRAK CX plays back MP3 and WMA format files in addition to WAV format files recorded on the unit. To play back a file recorded on the unit, select a folder from the VOICE (A-D) folders or the LINE (L) folder. To play back a file transferred from a computer, select the MUSIC (M) folder.

1. While the main screen is displayed, press the [FOLDER/A-B REPEAT] button located on the side panel repeatedly to select a folder from which to play back a file.

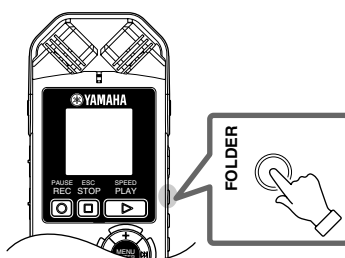

### Hint:

- Pressing the [FOLDER/A-B REPEAT] button repeatedly will scroll through the folders.

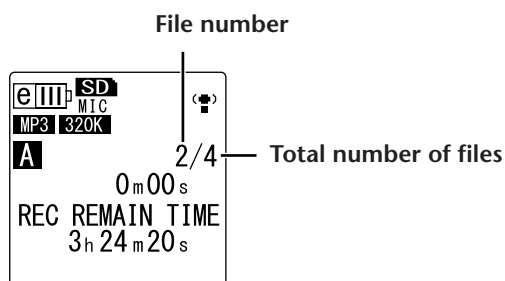

2. Press the [◀◀]/[▶▶] buttons to select the desired file number.

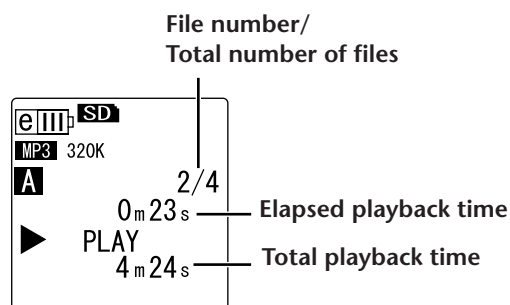

3. Press the [PLAY/SPEED ▶] button.  
The recorder starts playing back the file.



4. Press the [VOL +/-] buttons to set the proper playback volume level.  
The level can be set in 21 steps (0-20).

5. Press the [STOP/ESC  ] button to stop playback.  
Press the [PLAY/SPEED  ] button again to resume playback.

**Hint:**

- You can play the files in each folder from the list screen (see [page 8](#)).

## Playing back tracks from the Playlist

**Hint:**

- For information on creating a Playlist, refer to [page 66](#).

1. While the main screen is displayed, press the [FOLDER/A-B REPEAT] button located on the side panel repeatedly to select the M (MUSIC) folder.
2. Press the [◀◀]/[▶▶] buttons to select the desired Playlist, then press the [MENU/ENTER] button.
3. Press the [PLAY/SPEED  ] button.  
The recorder starts playing the tracks in the sequence specified in the Playlist.

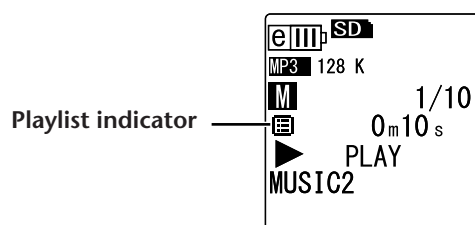

To resume normal playback, press the [FOLDER/A-B REPEAT] button while the unit is stopped.

**Note:**

- The unit will not play the tracks from a Playlist if the Playlist contains an error in the drive name, folder name, file name, etc.

## Indicators displayed during playback

- VOICE (A-D) folders and LINE (L) folder

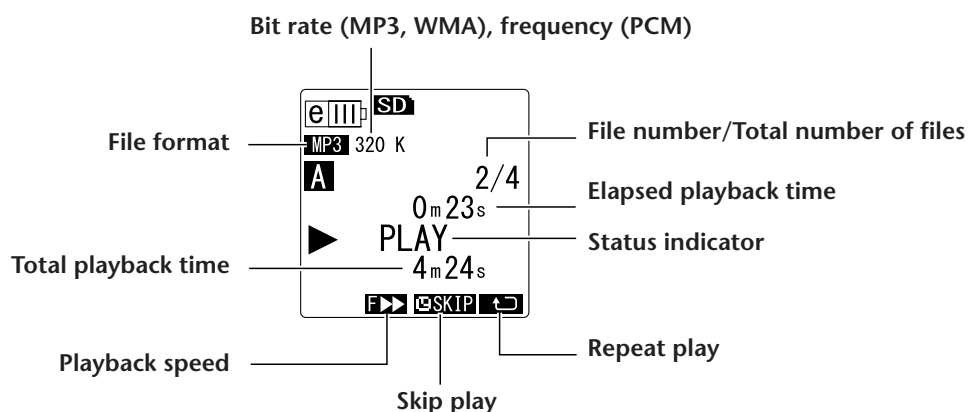

- MUSIC (M) folder

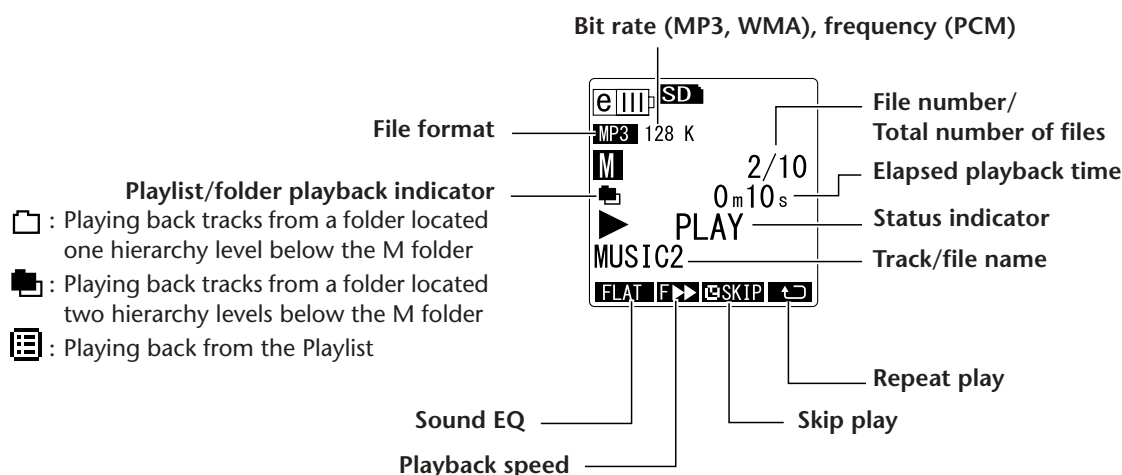
**Note:**

- With some files, the indicated elapsed playback time may not match the actual elapsed time. Also, the names of certain artists or tracks stored in the unit may not be displayed.

## Fast forwarding and fast reversing

### ■ Fast forwarding and fast reversing

Press and hold down the [▶▶] button during playback to fast forward the currently-playing file. Press and hold down the [◀◀] button during playback to fast reverse the currently-playing file.

Release the button at the point from which you wish to play. Playback will resume immediately from that point.

### ■ Locating the file to play back

Press the [▶▶] button once briefly while the unit is playing or stopped to locate the beginning of the next file.

Press the [◀◀] button once briefly to locate the beginning of the previous file.

### ■ Locating the index

While the unit is playing back a file that contains index marks, press the [▶▶] button once briefly to skip to the next index mark.

Press the [◀◀] button once briefly to locate the previous index mark.

#### Hint:

- For information on inserting index marks, refer to [page 40](#).

## Using headphones

Use headphones if you do not want sound to be output from the speaker or if the sound from the speaker is difficult to hear. Connect the headphones to the headphones socket located on the side panel of the unit.

You can listen to music and enjoy better sound quality by using the headphones and setting the Sound EQ function (see [page 34](#)).

**Note:**

- The Sound EQ function is effective only for playback through headphones.

# Playback Settings

## Changing the playback speed

You can decrease or increase the playback speed, if necessary. This is useful if you want to listen carefully to complex musical parts or to skip quickly through unimportant parts of a recorded meeting.

**1. During playback, press the [PLAY/SPEED ►] button.**

Each press of the button will cycle through three playback speeds: PLAY (normal), SLOW and FAST. The corresponding playback speed indicator appears on the screen.

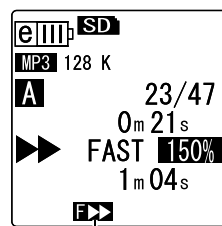

Playback speed (FAST)

The playback speed varies with the file format as follows:

	PLAY (normal)	SLOW	FAST
Indicator	none	S ►	F ►►
MP3	100%	70%	150%
WMA	100%	70%	120%

The recorder remembers the changed playback speed after the playback is stopped, and will use that speed for the next playback operation. However, the playback speed will be reset to “normal” when the power is turned off.

**Note:**

- You can change the speed only for playback of MP3 and WMA files. You cannot change the speed for playback of PCM (WAV) files.
- Some files may not play correctly when the playback speed is changed.

## Playing back specific sections of a track

You can specify and quickly locate a desired section of a track in three ways. This can be useful if you want to skip unimportant parts during playback or to repeat playback of a particular portion of the file. The POKETRAK CX features three special playback functions: Skip playback (locating the playback point immediately), A-B Repeat playback (playing a specified part repeatedly), and Phrase playback (moving the playback point back by a specified number of seconds).

### Using the Skip playback function

You can skip forward or back by a specific amount of time. This function is useful when you want to locate a desired playback point immediately.

1. During playback, press the [▶▶]/[◀◀] buttons.  
Playback will skip ahead or back by the specified amount of time.

#### Note:

- The playback point will not skip to the next or previous folder. The function is effective only within one folder.
- If the distance between the current point and an index mark or the beginning of the next file is shorter than the distance between the current point and the skip point, the recorder will locate the index mark or the beginning of the next file.

### ■ Setting the amount of time for Skip playback

1. Press the [MENU/ENTER] button for at least two (2) seconds while the main screen is displayed, select [PLAY MENU] → [SKIP PLAY], then press the [MENU/ENTER] button.
2. Press the [VOL +/-] buttons to select a skip time value of "30 sec," "1 min," "10 min" or "30 min," then press the [MENU/ENTER] button.
3. Press the [STOP/ESC ] button twice.  
The unit displays the main screen, including the **SKIP** indicator in the lower-right corner.

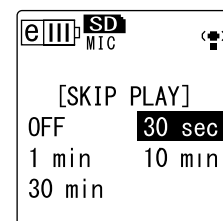

#### 💡 Hint:

- You can set the skip time value by displaying the menu screen during playback.

## Using the A-B Repeat playback function

During playback, you can specify a part of a file that you want to play repeatedly (from point A to point B).

1. During playback, press the [FOLDER/A-B REPEAT] button at the desired start point (A) for A-B Repeat playback.

The start point indicator lights up.

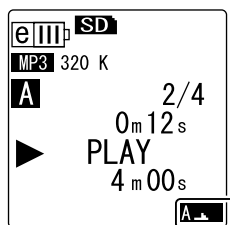

Start point indicator

2. Press the [FOLDER/A-B REPEAT] button at the desired end point (B) for A-B Repeat playback.

The end point is set, and the unit starts playing back the part between A and B repeatedly until you cancel the A-B Repeat function.

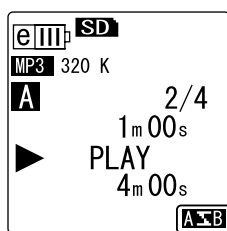

A-B Repeat indicator

To cancel A-B Repeat playback, do one of the following operations during A-B Repeat playback:

- Press the [FOLDER/A-B REPEAT] button again.
- Press the [STOP/ESC  ] button.
- Press the [◀◀]/[▶▶] buttons.

### Note:

- If the duration between point A and B is too short, you will be unable to set up A-B Repeat playback.
- If you set point A, but not point B, the end of the file will automatically become point B.

## Using the Phrase playback function

You can move back the playback point in the currently-playing file by a specified number of seconds. This function is useful if you want to listen again to a short phrase in a piece of music or an important piece of audio.

1. During playback, press the [EDIT/PHRASE] button.

The playback point will move back by the specified number of seconds and playback will resume.

**Note:**

- During A-B Repeat playback, the Phrase playback function remains effective between points A and B.
- If the specified number of seconds exceeds the time between the current playback point and the beginning of the file, the unit will play back from the beginning of the file.
- The playback point can be moved back to the beginning of the file, but no further. It cannot jump into the previous file.

■ **Setting the amount of time for Phrase playback.**

1. Press the [MENU/ENTER] button for at least two (2) seconds while the main screen is displayed, select [PLAY MENU] → [PHRASE PLAY], then press the [MENU/ENTER] button.
2. Press the [VOL +/-] buttons to select the amount of time to move back the playback point (5, 10 or 15 seconds), then press the [MENU/ENTER] button.
3. Press the [STOP/ESC ] button twice. The recorder displays the main screen.

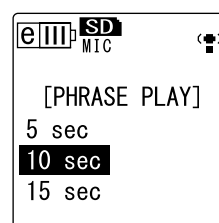

 **Hint:**

- You can specify the amount of time for Phrase playback by displaying the menu screen during playback.

## Playing back the same track repeatedly

You can play back the same track repeatedly (Repeat playback). The Repeat playback function features various Repeat playback modes, such as playing back the same file repeatedly, playing files in a folder in normal or random sequence, etc.

■ **Setting the Repeat playback mode**

1. Press the [MENU/ENTER] button for at least two (2) seconds while the main screen is displayed, select [PLAY MENU] → [REPEAT], then press the [MENU/ENTER] button.
2. Press the [VOL +/-] buttons to select a Repeat playback mode from [OFF], [ONE], [ALL] or [RANDOM], then press the [MENU/ENTER] button.

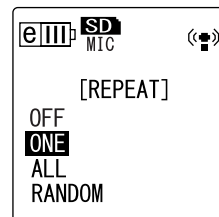



[OFF]	No repeat
[ONE]	Repeats only the currently-selected file.
[ALL]	Repeats all files in the current folder. (The unit will not perform Repeat playback across folders.)
[RANDOM]	Repeats all files in the current folder in random sequence. (The unit will not perform Random playback across folders.)



**3. Press the [STOP/ESC □ ] button twice.**

The unit displays the main screen with the Repeat mode indicator in the lower-right corner.

	ONE
	ALL
	RANDOM

**4. Press the [PLAY/SPEED ▷ ] button.**

The unit will perform the selected Repeat playback.  
To cancel Repeat playback, select [OFF] as the Repeat playback mode.

**Hint:**

- You can select a Repeat playback mode by displaying the menu screen during playback.

## Playing back with less noise (Clear Voice)

The Clear Voice function makes audio playback less static or noisy and easier to listen to. You can use this function for the files in the VOICE (A-D) folders. This function is not effective on files in the LINE (L), MUSIC (M) and Recycle Bin (  ) folders.

**1. During playback, press and hold down the [FOLDER/A-B REPEAT] button located on the side panel for at least two (2) seconds.**

The Clear Voice function turns on.

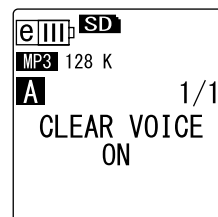

Press and hold down the [FOLDER/A-B REPEAT] button again for at least two (2) seconds to turn off the function.

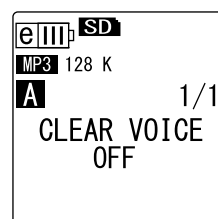

**Note:**

- This function is especially effective on the playback of files recorded in PCM 48/44.1kHz or MP3 320/192/128kbps mode.
- Depending on how the audio was originally recorded, the noise may not be reduced.

## Setting the sound EQ (equalizer) (applicable only to the M and L folders)

You can set the sound EQ to adjust the overall tone of music. The function is available only when you play back files in the LINE (L) or MUSIC (M) folder through the headphones.

### About the sound EQ options

The POCKETRAK CX offers six sound EQ presets and one USER EQ option (which enables you to cut and boost five bands individually to suit your preference). The sound EQ presets include FLAT, BASS1, BASS2, POP, ROCK and JAZZ.

#### Features of each sound EQ preset

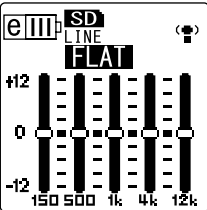
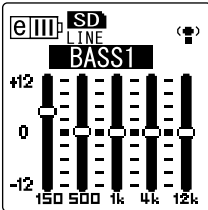
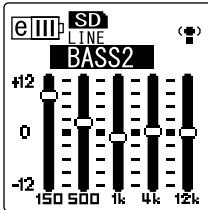
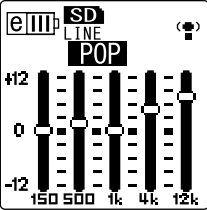
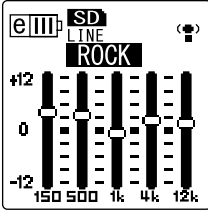
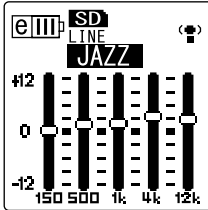
FLAT	BASS1	BASS2
		
No EQ is used. The original sound will be played as is.	This preset mildly boosts the lower frequency range.	This preset significantly boosts the lower frequency range.
POP	ROCK	JAZZ
		
This preset significantly boosts the higher frequency range.	This preset mildly boosts the lower and higher frequency ranges.	This preset boosts the mid frequency range.

**Note:**

- You cannot change the parameters of the six sound EQ presets. Use the USER EQ option if you wish to adjust the sound EQ to suit your preference.

## Selecting a sound EQ option

1. Press the [MENU/ENTER] button for at least two (2) seconds while the main screen is displayed, select [PLAY MENU] → [SOUND EQ], then press the [MENU/ENTER] button.



2. Press the [◀◀]/[▶▶] buttons to select the desired sound EQ option.  
Select from six sound EQ presets and one USER EQ option (which enables you to customize the EQ settings).

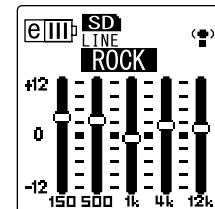

**Hint:**

- For information on how to customize the USER EQ option, refer to “Customizing the sound EQ option” on [page 36](#).

3. Press the [MENU/ENTER] button.  
The selection of the sound EQ option is confirmed.
4. Press the [STOP/ESC □] button.  
The recorder displays the main screen.

**Hint:**

- You can select a sound EQ option by displaying the menu screen during playback.

## Customizing the sound EQ option

The USER sound EQ option enables you to adjust the level of five EQ bands.

### 1. Select "USER" as the sound EQ.

Refer to steps 1 and 2 in the "Selecting a sound EQ option" section on [page 35](#).

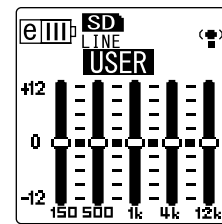

### 2. Press the [VOL -] button.

The 150Hz band will be selected and displayed as a black bar.

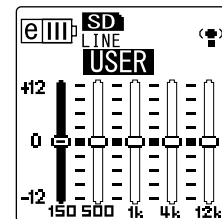

### 3. Press the [I◀◀]/[▶▶I] buttons to select the frequency band to cut or boost.

The selected frequency band will be displayed as a black bar.

### 4. Press the [VOL +/-] buttons to boost or cut the level of the selected frequency band.

You can boost the level by as much as +12dB or cut the level by as much as -12dB in 1dB steps. The larger value will raise the playback level and boost the frequency band.

#### Note:

- To adjust the level of other frequency bands, repeat steps 3 and 4.
- To cancel the operation, press the [STOP/ESC □ ] button.

### 5. Press the [MENU/ENTER] button.

The USER sound EQ option is now customized.

### 6. Press the [STOP/ESC □ ] button twice.

The recorder displays the main screen.

# Editing Files

## Dividing files

You can divide any file recorded and stored in the VOICE (A-D) folders or LINE (L) folder into two pieces. This feature enables you to remove an unwanted part of a recording while retaining the part you wish to keep.

### ⚠ IMPORTANT

Once a file is divided in two, the pieces cannot be rejoined. Be sure to backup important files on a computer or other device before you divide any file.

1. While the main screen is displayed, press the [FOLDER/A-B REPEAT] button located on the side panel repeatedly to select a folder that contains the file you want to divide.
2. Press the [◀◀]/[▶▶] buttons to select the desired file number, then press the [PLAY/SPEED ▶] button.  
The recorder starts playing back the file.
3. Press the [STOP/ESC ◻] button at the point at which you wish to divide the file.  
The recorder stops playback.
4. Press the [EDIT/PHRASE] button located on the side panel, press the [VOL +/-] buttons to select [DIVIDE], then press the [MENU/ENTER] button.

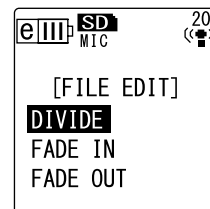

5. Press the [◀◀]/[▶▶] buttons to select [YES], then press the [MENU/ENTER] button.  
The recorder displays the message "DIVIDING...", then "DIVIDE COMPLETED!" and the file division operation is complete.  
When a file is divided, the number of files in the folder increases by one.

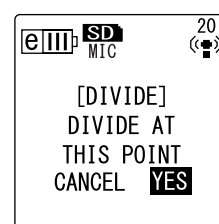

### Note:

- You can divide only MP3 or WAV files recorded on the unit.
- If the file length is too short, the unit displays the message "CANNOT DIVIDE AT THIS POINT!" and the file will not be divided. This function is not effective on files in the MUSIC (M) and Recycle Bin folders.
- If you divide a file that contains index marks (see page 40), the index marks will be deleted.

■ File names after division

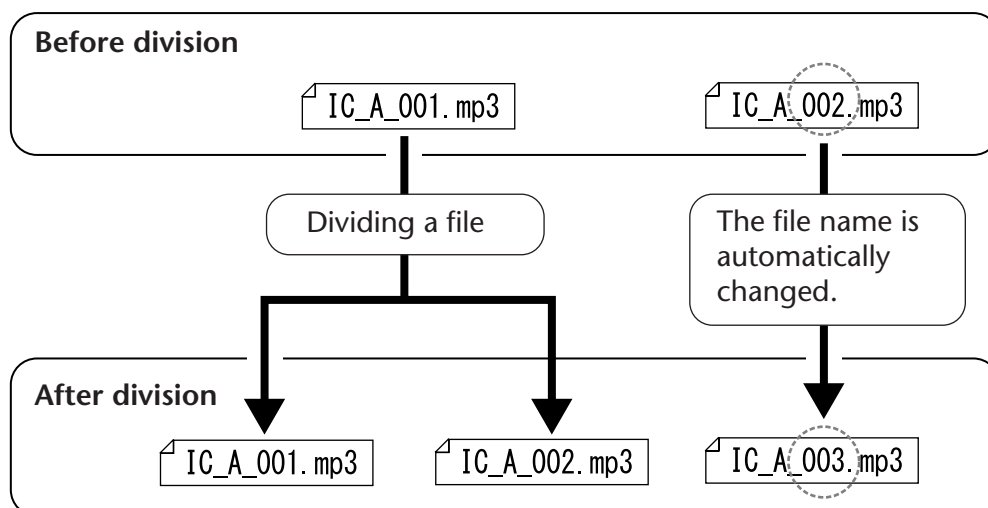

For example, if you divide a file named “IC\_A\_001.MP3”, a new file named “IC\_A\_002.MP3” will be created. If the new file has the same name as a file that already exists in the folder, the new file will keep the name, and the existing file will be renamed automatically.

■ Overlap time and minimum file length required for division

The two pieces created by a file division overlap each other at the division point as shown in the table below. To be divided successfully, a file must be twice the overlap time or longer in duration.

Recording mode		Overlap time	Required length
MP3	32 kbps	About 8 seconds	About 16 seconds or longer
	64 kbps	About 4 seconds	About 8 seconds or longer
	128 kbps	About 2 seconds	About 4 seconds or longer
	192 kbps	About 1 second or shorter	About 2 seconds or longer
	320 kbps		
PCM	44.1 kbps	About 1 second or shorter	About 2 seconds or longer
	48 kbps		

## Using the fade in and fade out effects

The POCKETRAK CX enables you to apply fade in and fade out effects to the files recorded in PCM (WAV) format. The fade in effect raises gradually the volume level of the first four seconds of the file. The fade out effect reduces gradually the volume level of the last four seconds of the file.

### ⚠ IMPORTANT

Once you apply the fade in/fade out effects, you cannot remove the effect. Be sure to backup important files on a computer or other external device before applying effects.

### Applying the fade in effect

1. While the main screen is displayed, press the [FOLDER/A-B REPEAT] button located on the side panel repeatedly to select a folder that contains the file to which you want to apply the fade in effect.
2. Press the [I◀◀]/[▶▶I] buttons to select the desired file number, then press the [EDIT/PHRASE] button located on the side panel.
3. Press the [VOL +/-] buttons to select [FADE IN], then press the [MENU/ENTER] button.

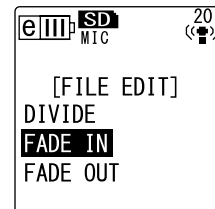

4. Press the [VOL +/-] buttons to select [YES], then press the [MENU/ENTER] button. The unit displays the message "FADE IN EXECUTING...".

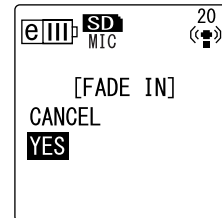

#### Note:

- If you have selected any file other than a PCM file recorded on the unit, or if you have selected a file of four seconds or less, the unit will display the message "CANNOT FADE IN!".

5. When the unit displays "COMPLETED", press the [VOL +/-] buttons to select [AUDITION], then press the [MENU/ENTER] button. The unit will play back the file with the fade in effect.

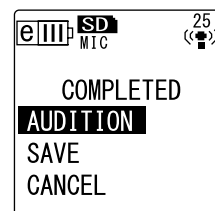

[AUDITION]	You can audition up to about 10 seconds at the beginning of the file with the fade in effect.
[SAVE] (Overwrite)	The file with the fade in effect will be saved. You cannot revert the file to its original status. (That is, you cannot undo the fade in effect.)
[CANCEL]	The fade in effect will not be applied.

- If you are satisfied with the file after auditioning and wish to save it, press the [VOL +/-] buttons to select [SAVE], then press the [MENU/ENTER] button. The file with the fade in effect will overwrite the original file. If you do not wish to overwrite the original file, select [CANCEL], then press the [MENU/ENTER] button.

**Note:**

- If the microSD card does not have sufficient free space, you will be unable to apply the fade in and out effects to the file.

## Applying the fade out effect

The basic procedure is the same as that for the fade in effect. Please refer to the “Applying the fade in effect” section on [page 39](#). Please note that you must select [FADE OUT] instead of [FADE IN] in step 3 to apply the fade out effect.



## Inserting and deleting index marks

Inserting index marks in a file enables you to locate the playback point immediately during the fast forward, fast reverse, or playback operation. You can insert index marks only in the files in the VOICE (A-D) folders.

### Inserting index marks

- During recording or playback, press the [LIST/INDEX] button (located on the side panel) at the point where you want to insert an index mark. The unit displays the message “INDEX SETTING...” and the index mark is inserted.

**Note:**

- Recording or playback continues after you insert an index mark. Repeat the same steps to continue inserting more index marks in the file, if necessary.
- You can insert up to 36 index marks in each file. If you try to insert more than 36 index marks, the unit displays “INDEX FULL!” and no more index marks will be recorded.
- If you divide a file that contains index marks, the index marks will be deleted.

### Deleting index marks

- While the main screen is displayed, press the [FOLDER/A-B REPEAT] button located on the side panel repeatedly to select a folder that contains a file from which you want to delete index marks.
- Press the [DEL] button located on the side panel.
- Press the [VOL +/-] buttons to select [INDEX], then press the [MENU/ENTER] button.

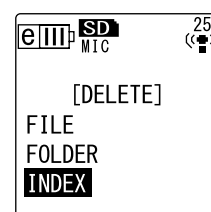



4. Press the [◀◀]/[▶▶] buttons to select the file from which you want to delete index marks, then press the [MENU/ENTER] button.  
The selected file number flashes.

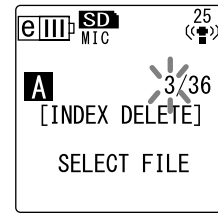

5. Press the [VOL +/-] buttons to select [YES], then press the [MENU/ENTER] button.  
The unit displays the message "DELETING..." and the index marks are deleted.

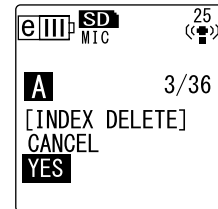

**Note:**

- Deleting index marks will not delete the audio recording.
- You cannot delete index marks individually. All index marks in a file will be deleted.
- If you delete a file that contains index marks, the index marks will be deleted even if the Recycle Bin function (see [page 42](#)) is turned on. If you move the file from the Recycle Bin back to the original folder, no index marks will be left in the file.

# Deleting

## Managing the Recycle Bin

If you delete a file on the recorder while the Recycle Bin function is active, the file will be moved to the Recycle Bin (  ) folder temporarily so that you can restore it later if necessary. If you delete a file or folder on the recorder while the Recycle Bin function is turned off, the file will be deleted completely and you will be unable to restore it. It is recommended that you turn the Recycle Bin function on to avoid accidental erasure.

### Note:

- The Recycle Bin folder can accommodate up to 500 files. If the Recycle Bin folder is full and you cannot move any more files to the Recycle Bin, move some files from the Recycle Bin folder to the original folder (see [page 43](#)) or empty the Recycle Bin folder (see [page 44](#)).

## Activating the Recycle Bin function

1. Press the [MENU/ENTER] button for at least two (2) seconds while the main screen is displayed, press the [VOL +/-] buttons to select [COMMON MENU] → [RECYCLE BIN] → [ON], then press the [MENU/ENTER] button.

The Recycle Bin function is turned on.

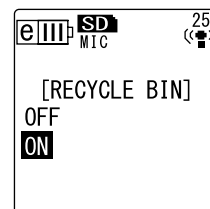

2. Press the [STOP/ESC  ] button twice to go back to the main screen.

### Note:

- You can move files to the Recycle Bin folder only from the VOICE (A-D) folders and LINE (L) folder. You cannot move files from the MUSIC (M) folder to the Recycle Bin folder, regardless of whether the Recycle Bin function is on or off. These files will be deleted completely by the delete operation.
- If you initialize a microSD card, all files on the card will be deleted (and will not be moved to the Recycle Bin folder). All files previously moved from the card to the Recycle Bin folder will also be deleted.
- If you move files to the Recycle Bin folder, the index marks in those files will be deleted automatically.
- If the Recycle Bin function is active, deleting the files will not increase the available recording time.

## Displaying the Recycle Bin folder

While the main screen is displayed, press the [FOLDER/A-B REPEAT] button located on the side panel repeatedly to select the Recycle Bin (  ) folder.

- The Recycle Bin folder contains no files.

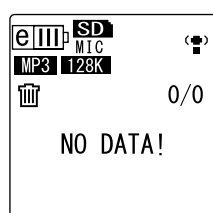

- The Recycle Bin folder contains files.

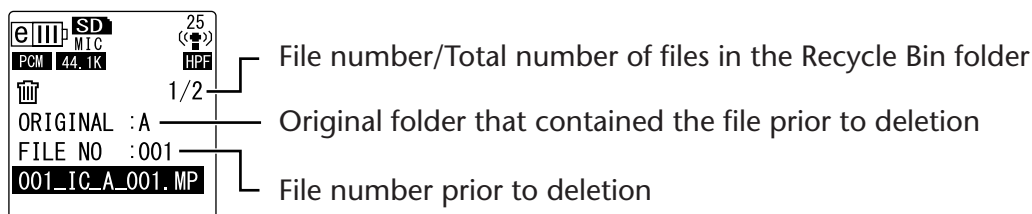

The files moved into the Recycle Bin will be renamed automatically (see page 59).

### Playing back a file in the Recycle Bin folder

1. While the main screen is displayed, press the [FOLDER/A-B REPEAT] button located on the side panel repeatedly to select the Recycle Bin (  ) folder.
2. Press the [◀]/[▶] buttons to select the desired file to play, then press the [PLAY/SPEED ▶] button. The selected file will play.

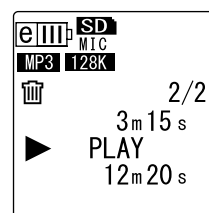

### Restoring a file from the Recycle Bin folder

1. While the main screen is displayed, press the [FOLDER/A-B REPEAT] button located on the side panel repeatedly to select the Recycle Bin (  ) folder.
2. Press the [DEL] button located on the side panel.
3. Press the [VOL +/-] buttons to select [RESTORE], then press the [MENU/ENTER] button.



4. When the Restore screen is displayed, press the [◀]/[▶] buttons to select the desired file, then press the [MENU/ENTER] button. The selected file number flashes.

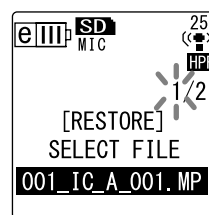

5. Press the [VOL +/-] buttons to select [YES], then press the [MENU/ENTER] button. The recorder will display the message "RESTORING...", then "RESTORED TO THE BOTTOM OF A" (if the file previously belonged to folder A), and the file will move back to its original folder.

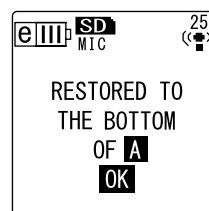

**Note:**

- A file restored from the Recycle Bin will be renamed automatically and added to the end of the file list in the original folder (see page 38).
- If the recorder displays the message “FOLDER FULL!,” the original folder contains the maximum number of files allowed. In this case, delete some files to clear some space.

**6. Press the [MENU/ENTER] button again.**

The recorder displays the main screen.

**Emptying the Recycle Bin folder**

1. While the main screen is displayed, press the [FOLDER/A-B REPEAT] button located on the side panel repeatedly to select the Recycle Bin (  ) folder.
2. Press the [DEL] button located on the side panel.
3. Press the [VOL +/-] buttons to select [EMPTY], then press the [MENU/ENTER] button.



**⚠ IMPORTANT**

*Emptying the Recycle Bin will permanently delete all files in the Recycle Bin and the same files from the microSD card. You will be unable to restore those files. Be sure to backup important files on a computer or other external device before emptying the Recycle Bin.*

4. Press the [VOL +/-] buttons to select [YES], then press the [MENU/ENTER] button.

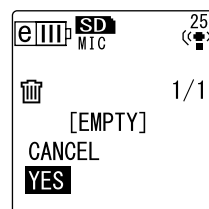

The recorder displays the message “EMPTYING...”, then “NO DATA!”, and the Recycle Bin is emptied.

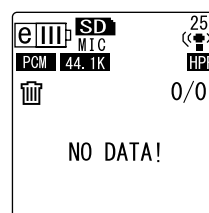

**Note:**

- If the Recycle Bin folder contains many files, the recorder’s operation may slow down. Empty the Recycle Bin regularly.

## Deleting a selected file

You can delete a single file from a folder.

### **⚠ IMPORTANT**

- If you delete a file while the Recycle Bin function is turned off (see [page 42](#)), you will be unable to restore it. Be sure to check the content of a file before you delete it.
- Before you proceed, make sure that the battery power is sufficient.

1. While the main screen is displayed, press the [FOLDER/A-B REPEAT] button located on the side panel repeatedly to select a folder from which to delete a file.
2. Press the [DEL] button located on the side panel.
3. Press the [VOL +/-] buttons to select [FILE], then press the [MENU/ENTER] button.

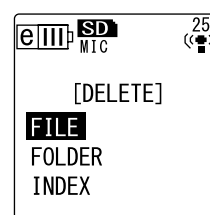

4. When the File Delete screen is displayed, press the [◀◀]/[▶▶] buttons to select a file to delete, then press the [MENU/ENTER] button. The selected file number flashes.

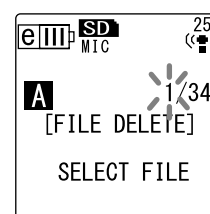

5. Press the [VOL +/-] buttons to select [YES], then press the [MENU/ENTER] button. The unit displays the message "DELETING..." and the file is deleted.

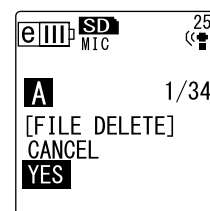

### Note:

- If you decide not to execute the delete operation, select [CANCEL], then press the [MENU/ENTER] button.
- You cannot cancel the delete operation if the recorder has already started the operation.

If the Recycle Bin function is active, the file will move to the Recycle Bin. When the recorder displays "MOVED TO RECYCLE BIN," select [OK], then press the [MENU/ENTER] button.

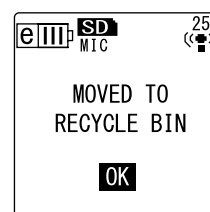

### Note:

- If the recorder displays the message "RECYCLE BIN FULL!," the Recycle Bin folder is full. Empty the Recycle Bin, then delete the file.

## Deleting all files from a folder

You can delete all files from a selected folder.

### **⚠ IMPORTANT**

- *If you delete all files from the selected folder while the Recycle Bin function is turned off (see [page 42](#)), you will be unable to restore them. Be sure to check the contents of a folder before you delete the files.*
- *Before you proceed, make sure that the battery power is sufficient.*

The procedure is similar to that for deleting a file. Please refer to the “Deleting a selected file” section on [page 45](#). Please note that you must select [FOLDER] instead of [FILE] in step 3 to delete all files from the folder.

### Note:

- *You cannot delete any sub-folders in the MUSIC (M) folder (see [pages 58 and 59](#)) by using this function. To delete these sub-folders, connect the recorder to a computer and delete the sub-folders by using the computer.*

## Formatting a microSD card (Deleting all data)

Formatting a microSD card will delete all files on the card, regardless of whether the Recycle Bin function is turned on or off.

You must also format a commercially available microSD card before you use the card for the first time.

### **⚠ IMPORTANT**

- *If you delete files from the microSD card, you will be unable to restore those files. Be sure to check the file contents before you delete a file.*
- *Be sure to backup important files on a computer or other external device.*
- *Before you proceed, make sure that the battery power is sufficient.*

1. Press the [MENU/ENTER] button for at least two (2) seconds while the main screen is displayed, press the [VOL +/-] buttons to select [COMMON MENU] → [FORMAT], then press the [MENU/ENTER] button.



2. Press the [VOL +/-] buttons to select [YES], then press the [MENU/ENTER] button. The unit displays the message “FORMATTING...”, then “FORMAT COMPLETED!”, and all data is deleted from the microSD card.

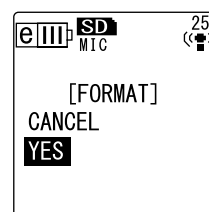

### Note:

- *If you decide not to execute the operation, select [CANCEL], then press the [MENU/ENTER] button.*
- *You cannot cancel the formatting operation if the recorder has already started the operation.*

3. Press the [STOP/ESC □] button twice. The recorder displays the main screen.

# Using the Timer Functions

## Programming Timer recording

Timer recording enables you to set the recorder so that it will start recording at the specified time. Before you proceed, make sure that the current date and time on the unit have been set correctly (see [page 9](#)).

1. Press the [MENU/ENTER] button for at least two (2) seconds while the main screen is displayed, press the [VOL +/-] buttons to select [COMMON MENU] → [TIMER & ALARM], then press the [MENU/ENTER] button.
2. Press the [VOL +/-] buttons to select [TIMER REC], then press the [MENU/ENTER] button. The recorder displays the timer indicator.
3. Specify the recording start time ([START TIME]). Press the [◀]/[▶] buttons to select the hour or minute, use the [VOL +/-] buttons to set the value, then press the [MENU/ENTER] button.



Timer indicator

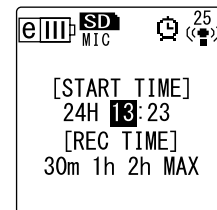
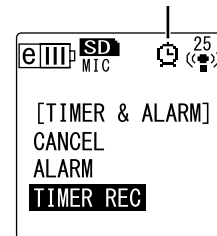

**Note:**

- You can program the time up to 24 hours ahead.

4. Specify the recording time duration ([REC TIME]). Press the [◀]/[▶] buttons to select the desired recording time duration from "30m," "1h," "2h" or "MAX" (recording continues until the available space used up). Then press the [MENU/ENTER] button.

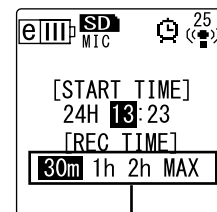

Recording time

5. When the unit displays [SELECT FOLDER], press the [◀]/[▶] buttons to select the desired folder into which to record, then press the [MENU/ENTER] button.

Timer recording is now programmed. At the programmed time, the recorder automatically starts to record, and a new file is created in the specified folder. (The timer indicator (🕒) will flash during Timer recording.)

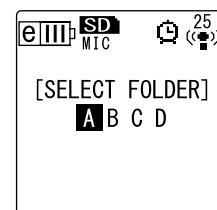



**Note:**

- You cannot select the LINE (L), MUSIC (M) or Recycle Bin (🗑️) folders for Timer recording.

## 6. Press the [STOP/ESC ] button twice.

The recorder displays the main screen.

### Note:

- The crossed-out timer indicator (  ) means that Timer recording is unavailable due to one of the following reasons:
  - There is no available recording time.
  - The specified folder contains 199 files.
  - The unit is currently playing back.
  - The unit is currently recording.
  - You are currently setting menu items.
- To remove the timer indicator (  ), cancel the programmed Timer recording.
- Timer recording will be cancelled once the programmed Timer recording has been executed.
- You cannot program Timer recording if the alarm has already been programmed, and vice versa.

### ■ Canceling Timer recording

Select [CANCEL] as in step 2 of the “Programming Timer recording” procedure, then press the [MENU/ENTER] button.

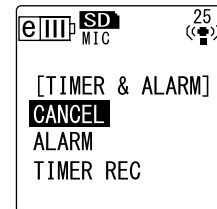

## Programming the alarm

If you program the alarm, it will sound at the specified time. You can specify your favorite song as the alarm sound instead of a beep. Before you proceed, make sure that the date and time on the unit have been set correctly (see [page 9](#)).

1. Press the [MENU/ENTER] button for at least two (2) seconds while the main screen is displayed, press the [VOL +/-] buttons to select [COMMON MENU] → [TIMER & ALARM], then press the [MENU/ENTER] button.
2. Press the [VOL +/-] buttons to select [ALARM], then press the [MENU/ENTER] button.  
The recorder displays the alarm indicator.



Alarm indicator

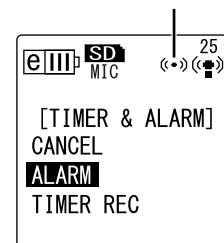



**3. Specify the alarm time ([ALARM TIME]).**

Press the [◀◀]/[▶▶] buttons to select the hour or minute, use the [VOL +/-] buttons to set the value, then press the [MENU/ENTER] button.

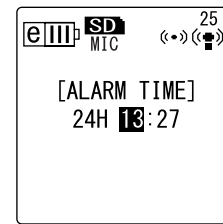
**4. Press the [VOL +/-] buttons to select [BEEP] or [MUSIC] as the alarm sound, then press the [MENU/ENTER] button.**

[BEEP]	Beep sound
[MUSIC]	A music file in the ALARM folder will be played.

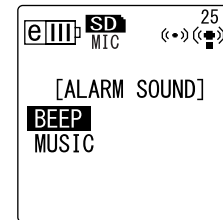
**Note:**

- If you wish to use your favorite song as the alarm instead of a beep, first connect the recorder to a computer, then place your favorite MP3 or WMA music file in the ALARM folder (see [page 58](#)). Then select [MUSIC]. If there is no file in the ALARM folder, a beep will sound instead of music. Make sure that the recorder's volume level is set appropriately. If the volume level is set to "0," you will not hear the alarm at the programmed time.

**5. Press the [STOP/ESC □] button twice.**

The alarm is now programmed.

At the programmed time, the alarm will go off. If you selected "BEEP," a beep will sound for about 10 seconds. If you selected "MUSIC," the music file (the entire song) in the ALARM folder will be played back.

**Note:**

- The alarm indicator (◀•▶) will flash while the alarm is sounding.
- Press the [STOP/ESC □] button to stop the alarm.
- You can program the time up to 24 hours ahead.
- The alarm will be cancelled once the programmed alarm has sounded.
- You cannot program Timer recording if the alarm has already been programmed, and vice versa.

**■ Canceling the alarm**

Select [CANCEL] in step 2 of the "Programming the alarm" procedure, then press the [MENU/ENTER] button. The alarm indicator (◀•▶) disappears.

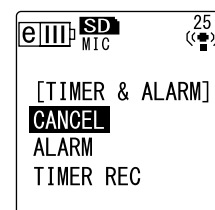

# About the Menu Settings

## Menu and menu item list

Menu items are categorized into three main menus: [REC MENU] (Recording settings), [PLAY MENU] (Playback settings) and [COMMON MENU] (Global settings).

### ■ [REC MENU] (Recording settings)

Menu items	Description	Reference page
[REC MODE]	Sets the recording quality.	16
[REC LIMITER]	Turns the Recording peak limiter on or off.	21
[HPF]	Turns the High Pass (Low Cut) filter on or off.	21
[STEREO WIDE]	Turns the Stereo wide recording on or off.	21
[REC SELECT]	Selects a source connected to the external input jack.	14
[AUTO DIVIDE]	Divides the file automatically after a certain period of silence during recording.	23
[SELF TIMER]	Sets the time for the Self Timer recording.	24
[VAS]	Turns the VAS (Voice activated system) on or off.	22

### ■ [PLAY MENU] (Playback settings)

Menu items	Description	Reference page
[REPEAT]	Sets the Repeat playback mode.	32
[PHRASE PLAY]	Sets the Phrase playback time (by the number of seconds the playback point will be moved back).	31
[SKIP PLAY]	Sets the Skip playback time (by the amount of time the playback point will skip).	30
[SOUND EQ]	Adjusts the tone.	34

### ■ [COMMON MENU] (Global settings)

Menu items	Description	Reference page
[BEEP SOUND]	Turns the beep sound on or off.	52
[REC/PLAY LED]	Turns the recording/playback indicator on or off, and also sets the recording peak LED.	25
[DATE & TIME]	Sets the calendar (date and time).	9
[TIMER & ALARM]	Sets up Timer recording and alarm.	47
[BATTERY SET]	Selects the eneloop or alkaline battery.	51
[AUTO OFF]	Turns the Auto Power Off function on or off.	52
[BACKLIGHT]	Turns the LCD backlight on or off.	52
[CONTRAST]	Adjusts the LCD contrast.	53
[RECYCLE BIN]	Turns the Recycle Bin function on or off.	42
[FORMAT]	Formats a microSD card (deletes all data)	46
[MENU RESET]	Initializes the menu settings.	53
[VERSION]	Indicates the firmware version information.	53

## Setting the menu options

The following section explains how to set the menu items. The example here explains how to select “MP3 128kbps” for the Recording mode.

1. Press and hold down the [MENU/ENTER] button for at least two (2) seconds while the main screen is displayed.
2. Press the [VOL +/-] buttons to select [REC MENU], then press the [MENU/ENTER] button.

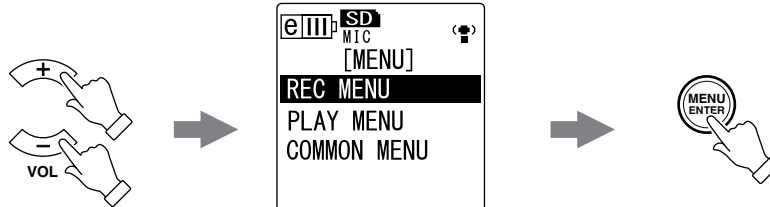

3. Press the [VOL +/-] buttons to select [REC MODE], then press the [MENU/ENTER] button.



4. Press the [VOL +/-] buttons to select [MP3 128kbps], then press the [MENU/ENTER] button.

5. Press the [STOP/ESC] button twice.  
The recorder displays the main screen.

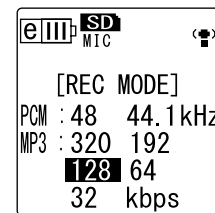

## Selecting the battery type

Select “eneloop” or “alkaline” depending on the battery type you plan to use.

### Procedure:

Press the [MENU/ENTER] button for at least two (2) seconds while the main screen is displayed, press the [VOL +/-] buttons to select [COMMON MENU] → [BATTERY SET], select [eneloop] or [ALKALINE], then press the [MENU/ENTER] button.

[eneloop]	Eneloop battery (included)
[ALKALINE]	Alkaline battery

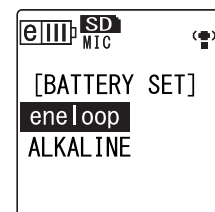

## Turning the beep sound on or off

You can set the recorder so that it will make a beep sound when you operate the buttons or if you make an operational error.

### Procedure:

Press the [MENU/ENTER] button for at least two (2) seconds while the main screen is displayed, press the [VOL +/-] buttons to select [COMMON MENU] → [BEEP SOUND] → [ON], then press the [MENU/ENTER] button.

To cancel the beep sound, select [OFF].

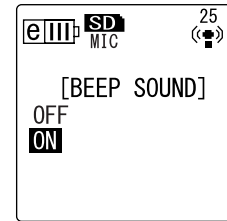

## Activating the Auto Power Off function

If this function is turned on and you leave the recorder turned on for about 15 minutes without using it, the recorder will automatically turn off (except during recording, VAS recording standby mode, or playback).

### Procedure:

Press the [MENU/ENTER] button for at least two (2) seconds while the main screen is displayed, press the [VOL +/-] buttons to select [COMMON MENU] → [AUTO OFF] → [ON], then press the [MENU/ENTER] button.

To cancel the Auto Power Off function, select [OFF].

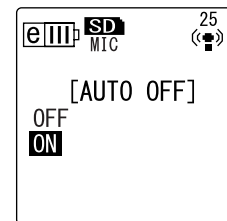

## Setting the Backlight function

When the Backlight function is turned on, the LCD backlight lights up for about 10 seconds each time you press a button or switch on the unit.

### Procedure:

Press the [MENU/ENTER] button for at least two (2) seconds while the main screen is displayed, press the [VOL +/-] buttons to select [COMMON MENU] → [BACKLIGHT] → [ON], then press the [MENU/ENTER] button.

To cancel the Backlight function, select [OFF]. (The backlight will not light up.)

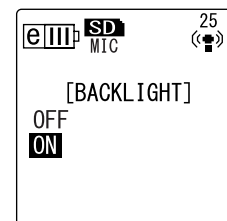

### Note:

- If the battery power is insufficient, the backlight will not light up.

## Adjusting the LCD contrast

You can adjust the LCD contrast on a scale of ten (10).

1. Press the [MENU/ENTER] button for at least two (2) seconds while the main screen is displayed, press the [VOL +/-] buttons to select [COMMON MENU] → [CONTRAST], then press the [MENU/ENTER] button.
2. Press the [◀◀]/[▶▶] buttons to adjust the contrast, then press the [MENU/ENTER] button.  
L (low): 1 – H (high): 10

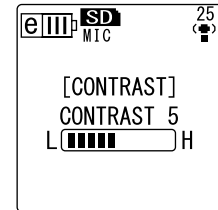
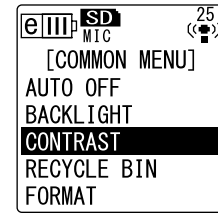

## Initializing the menu settings

Initializing the recorder settings will restore all menu settings (excluding the date and time setting) to the factory default.

### Note:

- Initializing the recorder settings will not delete any data on the microSD card. For information on initializing a microSD card, refer to [page 46](#).

### Procedure:

Press the [MENU/ENTER] button for at least two (2) seconds while the main screen is displayed, press the [VOL +/-] buttons to select [COMMON MENU] → [MENU RESET] → [YES], then press the [MENU/ENTER] button.  
If you decide not to initialize the settings, select [CANCEL].

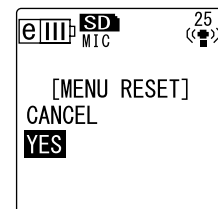

## Checking the firmware version

You can check the version number of the recorder's firmware by following the procedure below.

### Procedure:

Press the [MENU/ENTER] button for at least two (2) seconds while the main screen is displayed, press the [VOL +/-] buttons to select [COMMON MENU] → [VERSION], then press the [MENU/ENTER] button.  
The firmware version will be displayed.



# Using the POCKETRAK CX with a Computer

You can transfer audio files stored on the microSD card to a computer by connecting the recorder to the computer via an included USB cable. Transferred files are compatible for playback with Windows Media Player and iTunes, and can be edited using the included “Cubase AI” DAW software. You can also transfer audio files from a computer to the recorder for playback.

## Computer system requirements

### ■ Windows

Computer: Windows-based computer with built-in USB interface

OS: Windows Vista, XP Professional/Home Edition

### ■ Macintosh

Computer: Macintosh computer with built-in USB interface

OS: Mac OS X 10.4, 10.5

### Note:

- The menu items and buttons displayed on your computer may not exactly match those shown in this manual, depending on the OS version of your computer. This manual uses Windows XP and Windows Media Player 11 as examples.

Please visit the website below for the latest information on included software and system requirements.

<http://www.yamahasynth.com/>

## Connecting the recorder to your computer

1. Start the computer.
2. Make sure that the recorder is turned off, and then connect the included USB cable.

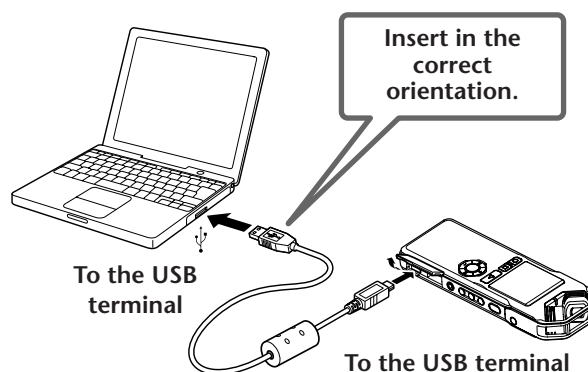

### ⚠ IMPORTANT

Use only the USB cable included with the recorder. The use of an improper cable may damage the terminal and result in a malfunction.

Once the recorder is recognized by the computer, the following display appears on the screen.

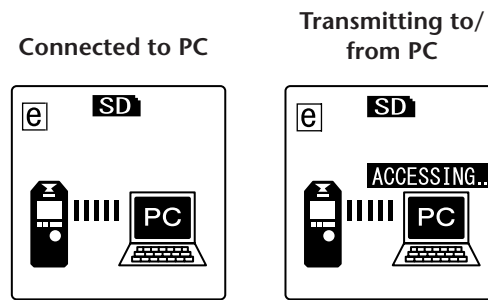

#### Precautions when using the USB terminal

Be sure to observe the following points when connecting the recorder to a computer's USB interface.

If you do not observe these points, you risk freezing the computer, corrupting the data, and losing the data. If the computer or the recorder freezes, restart the operating system or application software such as Windows Media Player.

#### **⚠ IMPORTANT**

- *Never disconnect the USB cable while data is being transferred.*
- *Be sure to wake the computer from sleep/suspended/standby mode before making a connection to the computer's USB terminal.*
- *Quit all applications running on the computer before connecting or disconnecting the USB cable.*

## Disconnecting the recorder from your computer

### ■ Windows:

1. Click  on the taskbar at the bottom right of the Windows screen, then click [Safely remove USB Mass Storage Device].
2. After the computer displays the message shown on the right, remove the USB cable.



### ■ Macintosh:

1. Drag and drop the drive icon ("NO NAME") of the recorder on the desktop to the Trash Can.
2. After the drive icon ("NO NAME") disappears from the desktop, remove the USB cable.

## Troubleshooting (Windows Vista/XP)

If the recorder is not recognized by the computer, refer to the information below:

### ■ Windows Vista

While the recorder remains connected to the computer, follow the steps below:

1. From the [Start] menu, right-click [Computer] to display the pop-up menu, then select [Properties] to open the "System" window.
2. Click [Device Manager] to open the user account control window. In this window, click [Continue] to open the "Device Manager" window.
3. Expand "Disk drives" and "Universal Serial Bus controllers." "Disk drives" must include "Yamaha Pocketrak USB Device" and "Universal Serial Bus controllers" must include the device name for the USB Mass Storage Device.

### ■ Windows XP

While the recorder remains connected to the computer, follow the steps below:

1. From the [Start] menu or on the desktop, right-click [My Computer] to display the pop-up menu, then select [Properties] to open the "System Property" window.
2. Click the [Hardware] tab, then click [Device Manager] to open the "Device Manager" window.
3. Expand "Disk drives" and "Universal Serial Bus controllers." "Disk drives" must include "Yamaha Pocketrak USB Device" and the "Universal Serial Bus controllers" must include the device name for the USB Mass Storage Device.

If the "Device Manager" window does not display the correct items:

Follow the steps below.

1. Exit (quit) all running applications.
2. Disconnect all external USB devices (excluding a properly working mouse and keyboard), then connect only the recorder.
3. If the computer features multiple USB terminals, use a different USB terminal to connect the recorder.
4. If the recorder is connected via a bus-powered USB hub, remove the hub, then use the included USB cable to connect the recorder directly to the computer's USB terminal.



## About files and folders

From a connected computer, you can manage the recorder's files that are stored in folders.

You can also transfer audio files from the recorder to a computer to save them, or from a computer to the recorder for playback.

1. **Connect the recorder to a computer.**  
Make sure that a microSD card is inserted in the unit.
2. **Click to open [My Computer] from the [Start] menu.**
3. **Double-click [Removable Disk].**  
The system displays the recorder's folders.

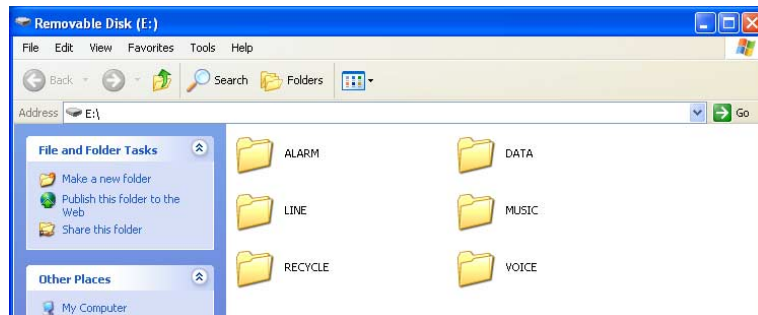

### Note:

- If the system displays the "What do you want Windows to do?" panel, click to select [Open folder to view files], then click [OK]. The system will display the recorder's folders.

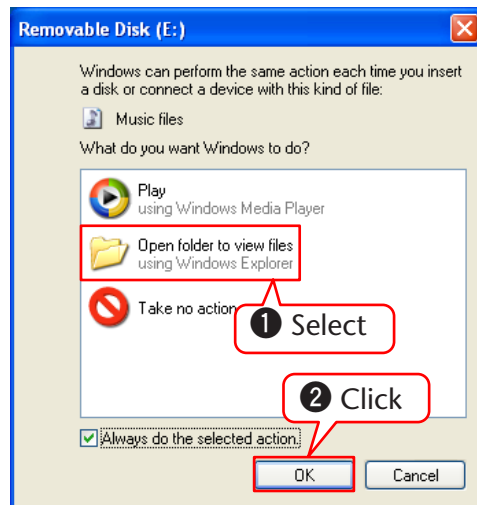

### ■ Files are stored in the following folders on the microSD card.

- **VOICE (A-D)**  
These folders store audio files (in MP3 or WAV format) recorded by the unit. The VOICE folder contains sub-folders A-D.

### Note:

- Do not move the files to a different folder. For example, do not move a file in the A folder to the B folder. Otherwise, you will be unable to play the file.
- Also, please note that if you change the name of an MP3 or WAV file (originally recorded on the unit) on the computer, then move the file back to the VOICE (A-D) folder, you will be unable to play the file on the unit. To play the file, first rename the file following the file naming rules, or move the file to the MUSIC (M) folder (see page 59).

- **MUSIC**

This folder stores music and other audio files transferred from a connected computer.

To play back the transferred files, the files must be in MP3 or WMA format or WAV files that were recorded on the unit. There are no naming rules that apply to these files.

**Note:** \_\_\_\_\_

- *The playback sequence may change if you add files to the MUSIC folder.*
  - *You can create sub-folders (up to two hierarchies) inside the MUSIC folder to organize the music files by albums or musicians (see [page 59](#)).*
  - *Please note that if the MUSIC (M) folder contains a file with the same name as that of the audio file you are transferring from the computer, the file in the MUSIC folder will be overwritten by the one transferred from the computer.*
- 

- **DATA**

This folder stores data files (of MS Excel, MS Word, etc.), and enables you to use the recorder as a USB flash drive.

**Note:** \_\_\_\_\_

- *The recorder will not play back any audio or music files that are placed in this folder.*
  - *This folder will be recognized only by a connected computer. The recorder will not display this folder on its screen.*
- 

- **LINE**

This folder stores files recorded from external devices via the line connection.

Please note that if you change the name of an MP3 file (originally recorded on the unit) on the computer, then move the file back to the LINE (L) folder, you will be unable to play the file on the unit. To play the file, first rename the file following the file naming rules, or move the file to the MUSIC (M) folder (see [page 59](#)).

- **RECYCLE**

This is the Recycle Bin folder. While the Recycle Bin function is active, files deleted on the recorder will move to this folder. You can restore files from the Recycle Bin folder, which can be a life saver if you delete a file accidentally.

- **ALARM**

This folder stores MP3 or WMA files, or WAV files recorded on the unit. Any of these files can be played as an alarm. Only one file at a time can be played as an alarm.

**Note:** \_\_\_\_\_

- *If this folder contains no files, the beep sound will be used as the alarm, regardless of the Alarm timer setting.*
  - *This folder will be recognized only by the connected computer. The recorder will not display this folder on its screen.*
-

## Folder structure of the POCKETRAK CX

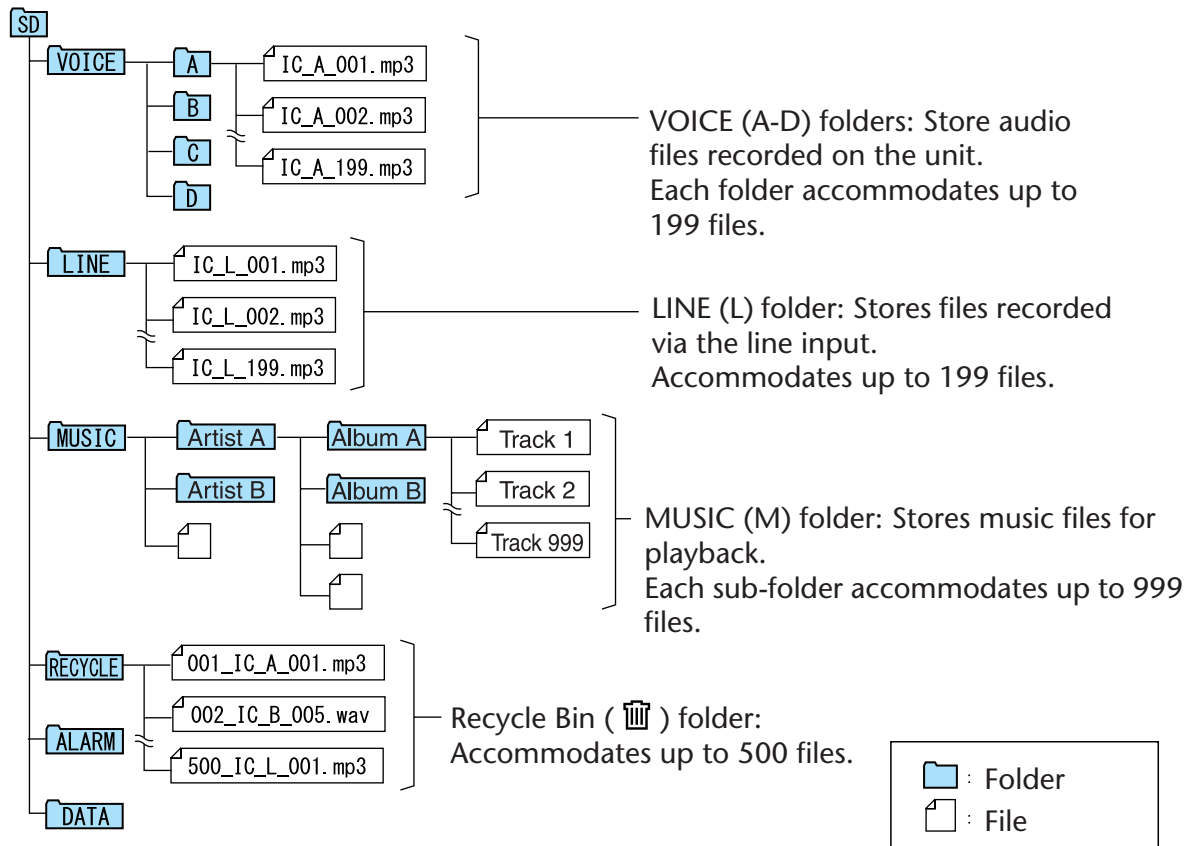

## About the file naming rules

The POCKETRAK CX automatically names the recorded files, following the file naming rules as shown below:

**IC\_A\_001.MP3**

①    ②    ③

- ① Folder name (Variable with a folder that contains the file.)
- ② File number (Each recording will be numbered sequentially, e.g., 001, 002, 003, etc.)
- ③ Extension (File format. MP3 for an MP3 recording file, and WAV for a PCM recording file.)

Files moved into the Recycle Bin will be renamed as follows:

**001\_IC\_A\_001.MP3**

①    ②    ③    ④

- ① File number in the Recycle Bin (Each file will be numbered sequentially based on when the file was moved to the Recycle Bin (e.g., 001, 002, 003, etc.)
- ② Folder name (The folder that originally contained the file before it was moved to the Recycle Bin.)
- ③ File number (The original number of the file before it was moved to the Recycle Bin.)
- ④ Extension (File format. MP3 for an MP3 recording file, and WAV for a PCM recording file.)

## Transferring audio files from the recorder to a computer

### ■ Windows:

1. Connect the recorder to a computer.
2. Open [My Computer] from the [Start] menu.
3. Double-click [Removable Disk].
4. Double-click the "VOICE" folder.
5. Double-click the folder (A-D) that contains the file that you wish to load to your computer.
6. Copy the file to the desired location.

### ■ Macintosh:

1. Connect the recorder to a computer.
2. Double-click the drive icon ("NO NAME") of the recorder on the desktop.
3. Double-click "VOICE" folder.
4. Double-click the folder (A-D) that contains the file that you wish to load to your computer.
5. Copy the file to the desired location.

### Hint:

#### · Transferring audio files from the computer to the recorder

*Drag and drop the audio file to the MUSIC (M) folder on the computer desktop in the Removable Disk icon (Windows) or recorder drive icon (Macintosh). Before transferring audio files to the VOICE (A-D) folders or LINE (L) folder, rename the files following the file naming rules (see [page 59](#)). The unit will not play files that do not comply with the file naming rule, unless they are in the MUSIC (M) folder.*

## Copying audio files to a CD-R

You can copy audio files (that were recorded on the POCKETRAK CX) to a CD-R disc by using Windows Media Player.

Please visit the Microsoft website for information on how to obtain Windows Media Player.  
<http://www.microsoft.com/windows/windowsmedia/>

### Note:

- This section uses Windows XP and Windows Media Player 11 as examples.
- To copy audio files to a CD-R disc, you must have a CD writer, such as a CD-R/RW drive.

1. From the [Start] menu, select [All Programs], then click [Windows Media Player] to start Windows Media Player.

**2. Right-click [Burn] in the menu bar, then select [Audio CD] or [Data CD].**

[Audio CD]	Audio files are converted to CD-DA format and copied to a CD-R/RW disc. You can play the disc on a CD-R compatible CD player in your home or car.
[Data CD]	Audio files (MP3 or PCM) are copied to a CD-R/RW disc without conversion. You can play the disc on a computer, but not on an audio CD player.

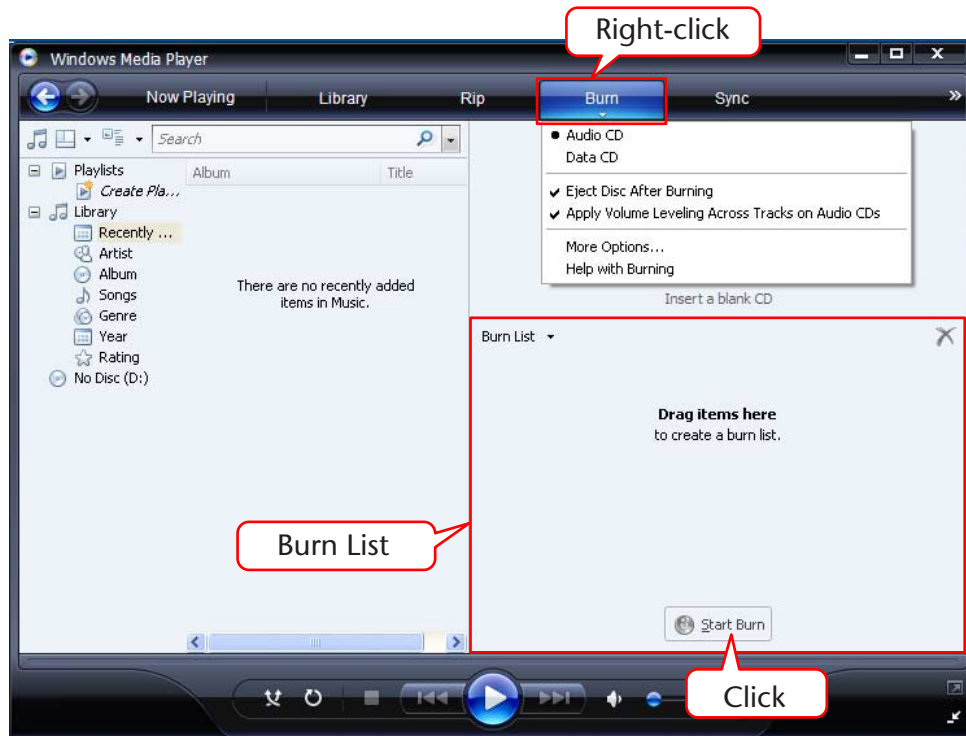

**3. Insert a new CD-R/RW disc into the CD-R/RW drive.**

**4. Drag and drop the audio files you wish to copy to the Burn List pane in the Windows Media Player panel.**

**5. Click [Start Burn] to start copying the files to the CD-R/RW disc.**

# Using the POCKETRAK CX as a Music Player

If you install Windows Media Player or iTunes on your computer and transfer music files to the connected POCKETRAK CX, you can use the unit as a music player.

Please visit the Microsoft website for information on how to obtain Windows Media Player.  
<http://www.microsoft.com/windows/windowsmedia/>

**Note:**

- This section uses Windows XP and Windows Media Player 11 as examples.
- Copying commercially-available music data is strictly prohibited except for your personal use.
- Yamaha makes no representations or warranties with regard to the content of files, and cannot be held responsible for the failure of transfers or downloads, or for damage or erasure of music files due to malfunction of the unit or your computer.

## Ripping CDs (Creating compatible music files from music CDs)

You can import music files from music CDs into your computer and convert them to MP3 or WMA files so that they can be played on the POCKETRAK CX.

1. From the [Start] menu, select [All Programs], then click [Windows Media Player] to start Windows Media Player.
2. Right-click [Rip] in the menu bar, then select [Format] → [mp3].

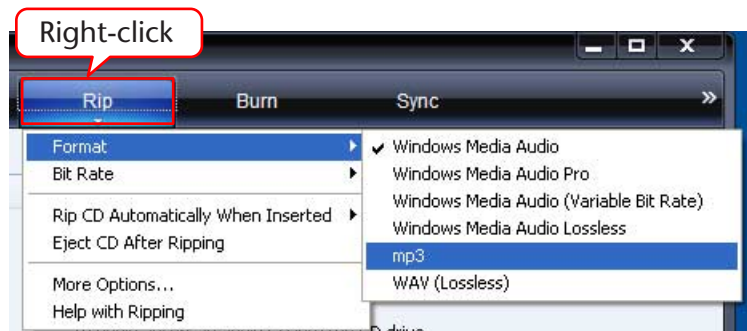

### 3. Click [Rip] in the menu bar.

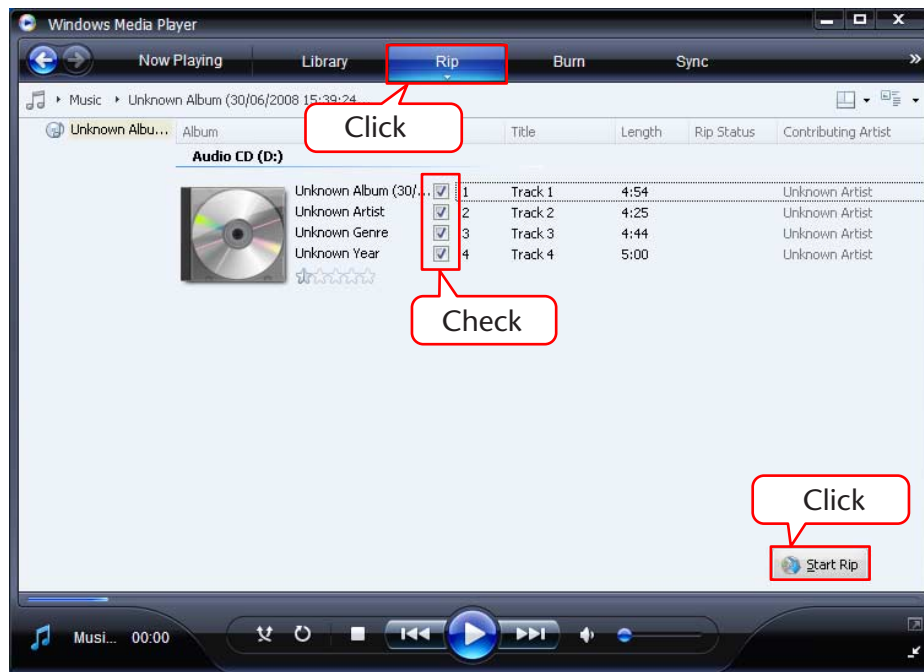

### 4. Insert a music CD into the computer's CD-ROM drive.

#### Note:

- If your computer has access to the Internet, the system will automatically obtain and display music information related to the CD.

### 5. Check the box for each song that you wish to rip to your computer, then click [Start Rip].

The system starts ripping the CD.

#### Note:

- You can also set Windows Media Player so that inserting a music CD will automatically start ripping.

## Transferring music files to the POCKETRAK CX (Sync function)

You can transfer audio files (ripped from a music CD to a computer) to the recorder for playback.

For information on how to rip a music CD, refer to the “Ripping CDs (Creating compatible music files from music CDs)” on [page 62](#).

1. From the [Start] menu, select [All Programs], then click [Windows Media Player] to start Windows Media Player.
2. Click [Sync] in the menu bar.
3. Connect the recorder to the computer.

**Note:**

· If the system displays the “Device Setup” window, click [Finish].

4. Right-click [Sync] in the menu bar, then select [Pockettrak] → [Advanced Options...].
5. Check the box for “Create folder hierarchy on device” on the [Sync] tab, then click [OK].

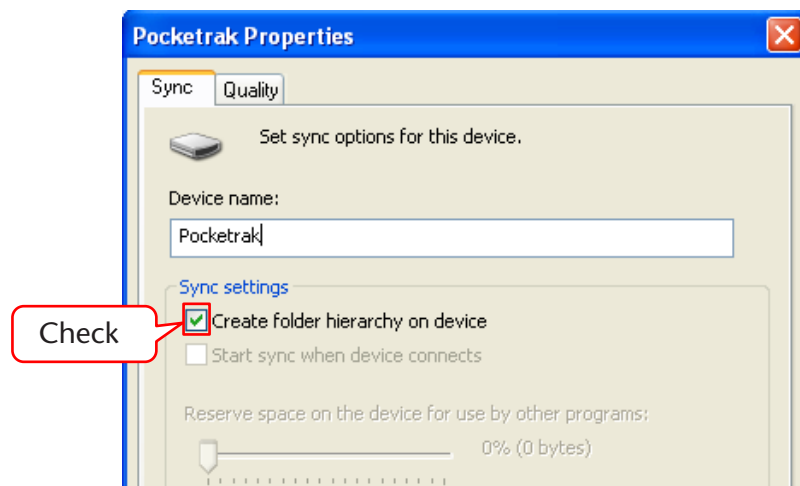

**Note:**

· If the box has already been checked by default, the folder may not be created. Remove the check from the box, then check the box again, and then click [OK].



6. Drag and drop the desired music files from the Library pane in the left column of the window to the Sync List pane in the right column of the window.

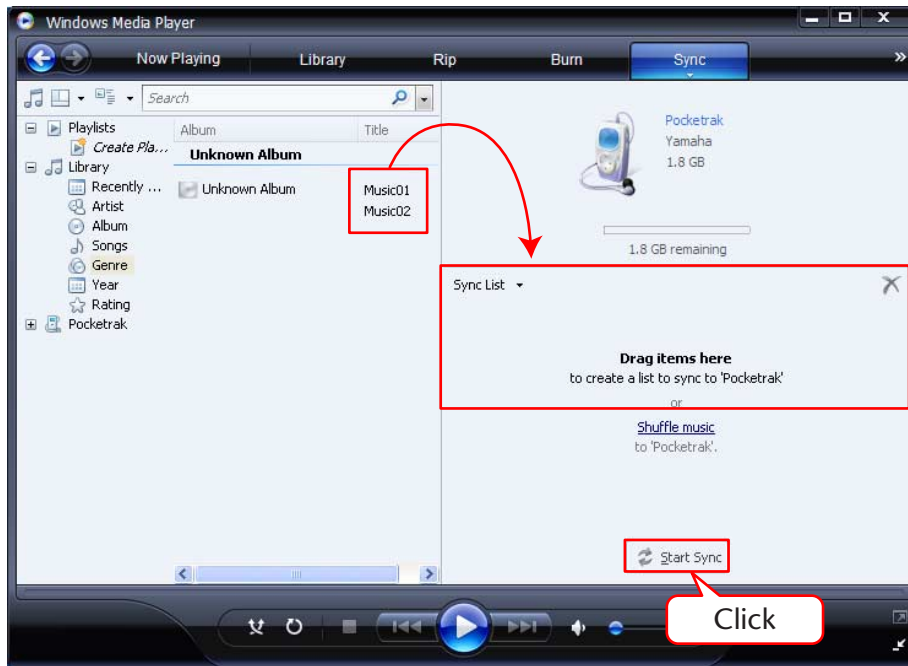

7. Click [Start Sync].  
The files will be transferred to the POCKETRAK CX.

## Playing back tracks in a specific sequence

### Creating a Playlist

You can create a Playlist to play back tracks in a desired sequence.

The recorder supports playlist files that are in M3U format with the extension “.m3u”. An M3U format file stores multimedia playlists that specify the location of media files (such as MP3 files).

1. From the [Start] menu, select [All Programs] → [Accessories], then click to open [Notepad].
2. Enter the file names included in the MUSIC (M) folder into the Playlist in the desired sequence.  
Enter the file names into the Playlist in the following format: “Drive name:\Folder name\File name”. See the example below.

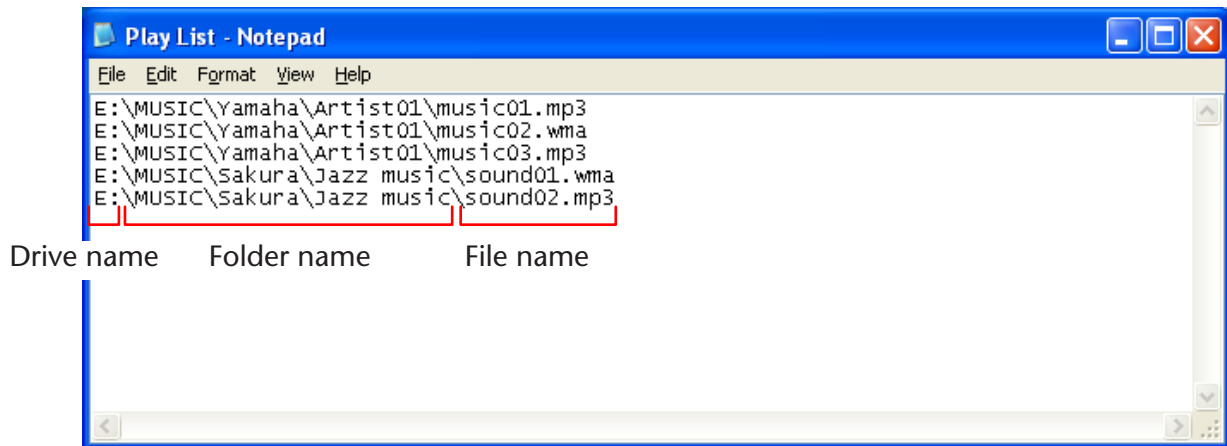

3. From the [File] menu, select [Save As...], then name the file “xxx(file name).m3u” to save the Playlist.
4. Transfer the saved Playlist file to the MUSIC (M) folder on the recorder (see [page 58](#)).  
Be sure to transfer the Playlist file directly to the root level of the MUSIC (M) folder.

**Note:**

- You must place the Playlist file at the root level of the MUSIC (M) folder, NOT in any sub-folder inside the MUSIC folder.

5. Disconnect the recorder from the computer (see [page 55](#)).

**Hint:**

- For information on how to play tracks from the Playlist, refer to [page 27](#).

# Importing Audio Files into Cubase AI

The POCKETRAK CX ships with a DVD disc that contains the DAW software “Cubase AI.” You can use this software to edit and mix audio files. This section explains how to install Cubase AI and import audio files. For more information on using Cubase AI, refer to the PDF manual supplied with the Cubase AI software.

## Step 1. Installing Cubase AI

### **IMPORTANT**

*Since the End-User Software License Agreement (EUSLA) displayed on your computer when you install the DAW software is superseded by the agreement in the included Owner’s Manual (printed version), you should disregard the EUSLA. Please read the Software License Agreement in the included Owner’s Manual carefully, and install the software if you agree to it.*

1. Start the computer and log on to the Administrator account.
2. Insert the included DVD-ROM into the computer's DVD-ROM drive.
3. Double-click the “CubaseAI4.msi” icon in the “Cubase AI 4 for Windows” folder (for Windows users), or double-click the “CubaseAI4.mpkg” in the “Cubase AI 4 for MacOS X” (for Macintosh users).

Follow the on-screen instructions to install the Cubase AI software.

### Note:

- *To continue to use Cubase AI and be eligible to receive support and other benefits, you will need to register the software and activate your software license by starting the software while the computer is connected to the Internet. Click the “Register Now” button that is displayed when the software is started, then fill in all fields required for registration. If you do not register the product, you will be unable to use the application after a limited period of time expires. For a detailed registration procedure of Cubase AI, refer to the web site below.*

*<[http://service.steinberg.de/goto.nsf/show/register\\_cubase\\_ai\\_4\\_gb](http://service.steinberg.de/goto.nsf/show/register_cubase_ai_4_gb)>*

## Step 2. Connecting the recorder to your computer

Connect the recorder directly to your computer using the included USB cable.

## Step 3. Importing audio data into Cubase AI

### 1. Launch Cubase AI.

#### Windows:

Click [Start] → [All Program] → [Steinberg Cubase AI 4] → [Cubase AI 4] to launch the program.

#### Note:

- If the "ASIO Multimedia" dialog window appears, click [Yes].

#### Macintosh:

Double-click the [Application] → [Cubase AI 4].

#### Note:

- If you specified a file destination when installing the Cubase AI software, launch the application from that location.
- Create a Cubase AI shortcut or alias on your desktop so that you can easily launch the program when required.

### 2. Select [New Project] from the [File] menu to create a new project file.

The new project dialog window will open. For this example select [CAI4 - 4 Stereo 8 Mono Audio Track Recorder] and click [OK].

#### Note:

- Recorded Cubase AI data is stored as a "project file."

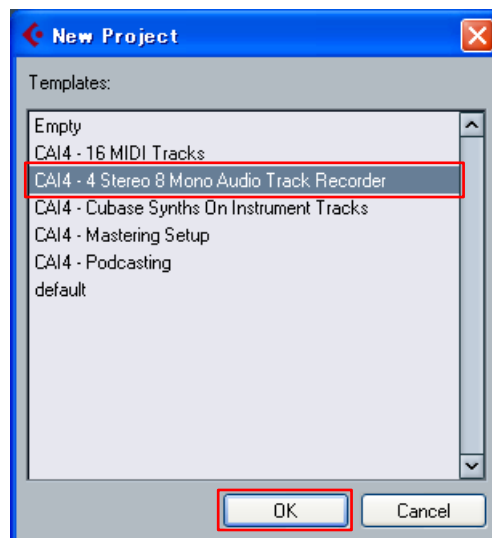

- When the directory selection dialog window appears, select the folder to which the project and audio files for the project are to be stored, and click [OK].  
An empty project window with 4 stereo and 8 monaural tracks will appear.

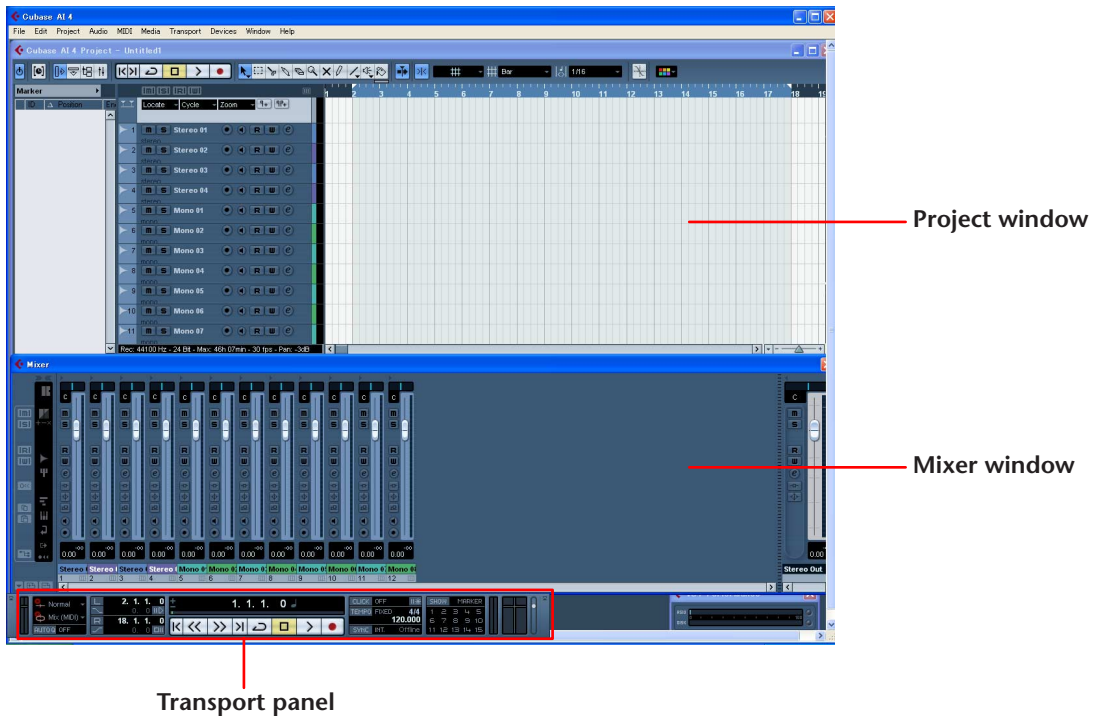

- Click in the track list (the area in which the track names are displayed) to select a track into which to import audio data.  
Various settings for the selected track are available in the Inspector on the left side of the display.

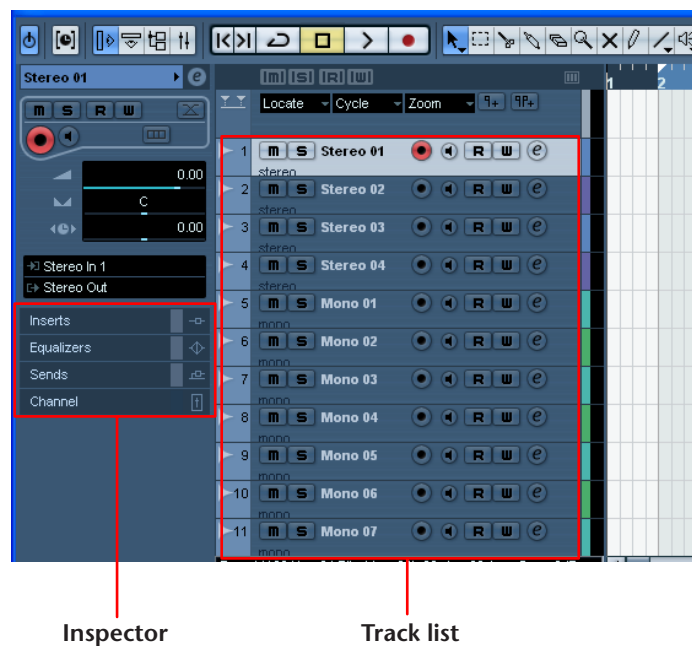

5. Go to [File] menu → [Import] → [Audio File] → [My Computer] → “Removable Disk”, then click [Open].

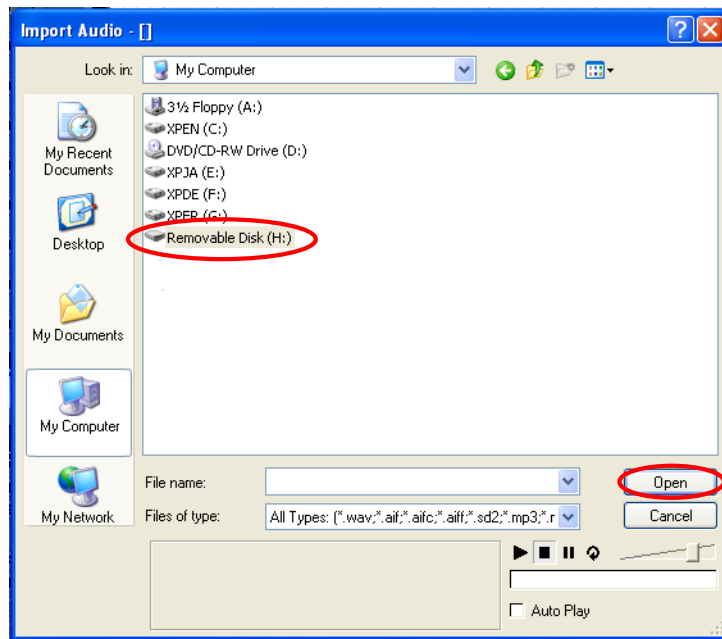

6. Select an audio file to import from the folder, then click [Open].

**Note:**

- If the “Import Options” dialog box appears, select the desired options, then click [OK].

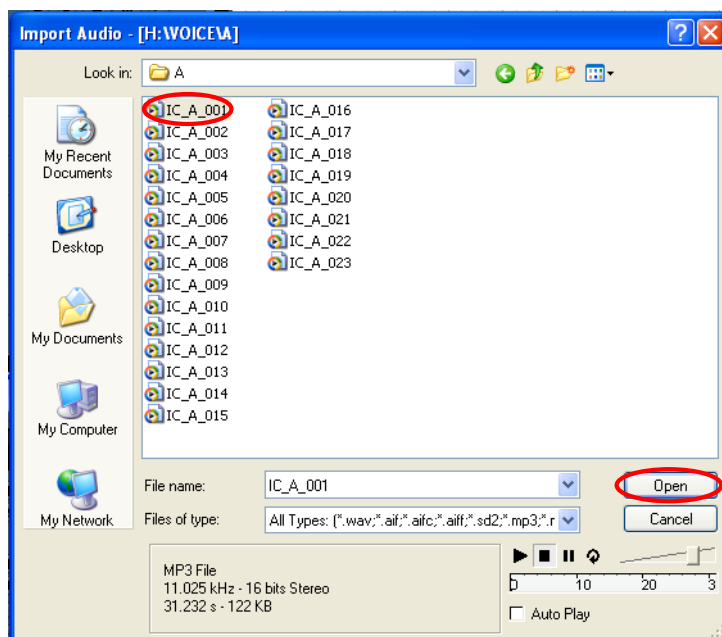

7. To save the project file, select [Save] from the [File] menu, enter a file name, then save the file.

Save your project file frequently to avoid losing unsaved data in case a problem occurs.

**Hint:**

- For further instructions such as adding effects or mixing, refer to the PDF manual provided with the software.

# Recharging the eneloop

## ⚠ WARNING

- Recharge the eneloop at an ambient temperature of between 5 and 35 degrees Celsius (41 and 95 degrees Fahrenheit).
- Be sure to close the battery cover before you start recharging.

### 1. Make sure that the eneloop battery is inserted in the recorder.

## ⚠ DANGER

- Do not attempt the recharge operation with an alkaline or other battery installed in the recorder. Otherwise, the battery liquid may leak or the recorder may malfunction.

### 2. From the main screen, press and hold down the [MENU/ENTER] button for at least two seconds to access the [COMMON MENU] → [BATTERY SET], then make sure that "eneloop" is selected.

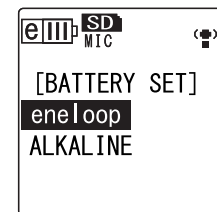

### 3. Connect the recorder to a computer (see page 54).

- ### 4. Make sure that the LCD screen on the recorder indicates that the unit is connected to the computer, then set the [HOLD/CHARGE] switch to [HOLD ▷].
- The LED lights up green, and recharging starts.
- To cancel the recharge operation, revert the [HOLD/CHARGE] switch setting.
- When recharging is complete, the LED turns off.

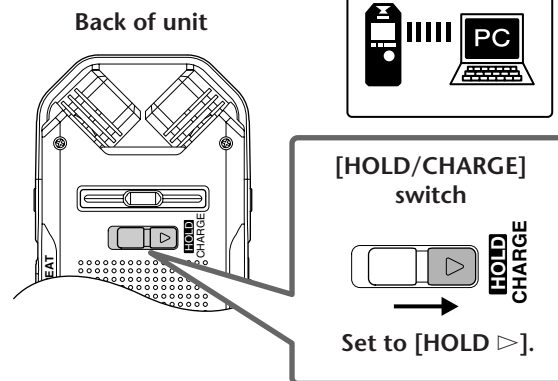

## Note:

- Recharging a completely exhausted eneloop battery takes approximately 220 minutes.
- You can recharge an eneloop battery during data transfer. However, the battery may be exhausted more quickly.

### 5. Disconnect the recorder from your computer.

## Note:

- The battery may become warm during recharge, but this is normal.
- The battery life has come to an end if the battery is exhausted relatively quickly even after being fully recharged. Replace it with a new eneloop AA Ni-MH rechargeable battery.
- The battery may not be recharged under the following conditions:
  - When the computer is in sleep mode
  - While the computer is being restarted
- The crossed-out battery icon (  ) means that the recharging operation did not start for one of the following reasons:
  - A non-eneloop battery has been loaded.
  - There is no battery in the unit.
  - The unit is overheated.

(Disconnect the unit from the computer, leave the unit with the power turned off for a while, then connect the unit to the computer again.)

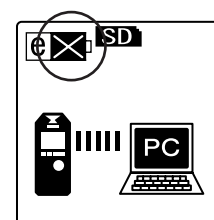

# Appendix

## Error messages

The following table explains the error messages that you may see during operation of the POCKETRAK CX.

Unit status or function	Error message	Description
Low battery	LOW BATTERY! REPLACE BATTERY	The alkaline battery is exhausted. Replace the battery with a new one.
	LOW BATTERY! CHARGE BATTERY!	The enloop is exhausted. Recharge the enloop.
Recording	MEMORY FULL!	The microSD card does not have sufficient free space for recording.
	FILE FULL!	You attempted to record more files than the maximum number of files allowed for the selected folder.
Playback	NO DATA!	You pressed the [PLAY/SPEED ▶] button but the selected folder contains no files.
	CANNOT CHANGE PLAYBACK SPEED!	You attempted to change the playback speed while playing back a PCM recording. You cannot change the playback speed of PCM (WAV) files.
Editing (Index)	INDEX FULL!	You attempted to insert more index marks than the maximum number (36) of index marks allowed per file. No more index marks will be recorded.
Editing (File division)	CANNOT DIVIDE! FOLDER FULL!	You attempted to divide a file when the corresponding folder contains the maximum number of files allowed.
	CANNOT DIVIDE! MEMORY FULL!	The microSD card does not have sufficient free space to divide a file.
	CANNOT DIVIDE! REC TIME TOO SHORT !	The recording is too short in duration to divide.
	CANNOT DIVIDE! AT THIS POINT	You cannot divide the file at the current point.



Unit status or function	Error message	Description
Editing (Fade in/fade out)	CANNOT FADE IN! FILE TOO SHORT!	The file is too short in duration (four seconds or less) to apply the fade in effect.
	CANNOT FADE OUT! FILE TOO SHORT!	The file is too short in duration (four seconds or less) to apply the fade out effect.
	CANNOT FADE IN! READ-ONLY FILE!	You attempted to apply the fade in effect to a file other than a PCM (WAV) file. You cannot apply the fade in effect to any files other than PCM (WAV) files.
	CANNOT FADE OUT! READ-ONLY FILE!	You attempted to apply the fade out effect to a file other than a PCM (WAV) file. You cannot apply the fade out effect to any files other than PCM (WAV) files.
	MEMORY FULL!	The microSD card does not have sufficient free space for applying the fade in or out effect.
Editing (General)	CANNOT EDIT! READ-ONLY MODE!	You pressed the [EDIT/PHRASE] button to edit a file in the MUSIC folder.
List screen	NO FILE	The selected folder does not contain any files that can be played on the unit.
Recycle Bin	CANNOT EDIT! READ-ONLY MODE!	You pressed the [EDIT/PHRASE] button to edit a file in the Recycle Bin folder.
	FOLDER FULL!	You cannot move the file from the Recycle Bin to its original folder because the folder contains the maximum number of files allowed.
	RECYCLE BIN FULL!	You attempted to delete a file while the Recycle Bin function was turned on and the Recycle Bin folder contained the maximum number of files allowed (500 files).
microSD card	NO MEDIA!	You attempted to record or play back a file with no microSD card inserted. Insert a microSD card.
	SD CARD ACCESS ERROR! INSERT AGAIN!	The recorder did not recognize the inserted microSD card, or the card is broken. Try inserting the card again.
	SD CARD WRITE SPEED TOO SLOW!	PCM recording was incomplete or the data was not written correctly.

## Troubleshooting

### The unit does not operate.

Possible cause	Battery is not inserted properly or is exhausted.
Corrective action	Reinsert the battery correctly. Recharge the enloop or replace with a new alkaline battery (see <a href="#">page 71</a> ).

### Buttons do not work.

Possible cause	The Hold function is set.
Corrective action	Set the [HOLD/CHARGE] switch (located on the rear panel of the unit) to its original position to cancel the Hold function.

Possible cause	The USB terminal is still connected to the computer.
Corrective action	Disconnect the unit from the computer (see <a href="#">page 55</a> ).

### The enloop cannot be recharged from the connected computer.

Possible cause	The BATTERY SET is set to "ALKALINE."
Corrective action	Set the BATTERY SET to "enloop" (see <a href="#">page 51</a> ).

Possible cause	The [HOLD/CHARGE] switch is not set correctly.
Corrective action	Set the [HOLD/CHARGE] switch to [HOLD ▷].

### Icon " " appeared when you attempted to recharge the battery.

Possible cause	<ul style="list-style-type: none"> <li>You attempted to recharge a battery other than the enloop.</li> <li>You attempted to recharge the battery, but no battery was inserted.</li> <li>The enloop is not inserted correctly.</li> </ul>
Corrective action	Insert the enloop battery into the unit.

Possible cause	The unit is overheated.
Corrective action	Disconnect the unit from the PC, let the unit cool down for a while, then try to recharge again.

### The unit does not recognize the inserted microSD card.

Possible cause	The microSD card is not inserted correctly.
Corrective action	Turn off the power to the unit, then insert the microSD card correctly.

Possible cause	The microSD card was formatted on a computer or device other than the recorder.
Corrective action	Use the POCKETRAK CX to format the microSD card (see <a href="#">page 46</a> ).

<b>No sound.</b>	
<b>Possible cause</b>	The volume is turned down too low.
<b>Corrective action</b>	Use the [VOL +/-] button to adjust the volume level.

<b>Files in the VOICE (A-D) folders cannot be played.</b>	
<b>Possible cause</b>	The file name is wrong.
<b>Corrective action</b>	If you change the file name on a computer, then move the file back to the VOICE (A-D) folder, you cannot play the file on the unit. Transfer the file to the MUSIC (M) folder to play it.

<b>Possible cause</b>	The audio file is not in the type of WAV format that is supported by the unit.
<b>Corrective action</b>	The unit will not play back a WAV file that was not recorded on the unit.

<b>Files in the MUSIC (M) folder cannot be played (correctly or at all).</b>	
<b>Possible cause</b>	The file is not in a playable format.
<b>Corrective action</b>	Use MP3 or WMA files.

<b>Possible cause</b>	The audio file is not in the type of PCM (WAV) format that is supported by the unit.
<b>Corrective action</b>	The unit will not play back a WAV file that was not recorded on the unit.

<b>Possible cause</b>	The file was transferred to an incorrect destination.
<b>Corrective action</b>	The unit will not play files that were transferred from a computer to a folder other than the MUSIC (M) folder. Be sure to transfer the file to the MUSIC (M) folder on the Removable Disk.

<b>Possible cause</b>	The file is not compatible with the unit.
<b>Corrective action</b>	Create a file using different MP3/WMA encoder software.

<b>Possible cause</b>	The files listed in the Playlist are missing from the MUSIC (M) folder.
<b>Corrective action</b>	Delete the file names from the Playlist. Alternatively, transfer the missing files to the MUSIC (M) folder.

<b>Possible cause</b>	A different transfer method was used.
<b>Corrective action</b>	Files protected by copyright cannot be played if they are transferred via Explorer. Use Windows Media Player to transfer the files (see <a href="#">page 64</a> ).

A file cannot be divided.	
Possible cause	The microSD card may have insufficient free space.
Corrective action	Erase unnecessary files (see <a href="#">page 45</a> ).

Possible cause	The file is too short to divide.
Corrective action	The minimum file length required for the file division operation varies with the recording mode (see <a href="#">page 38</a> ).

A file cannot be erased.	
Possible cause	The attribute of the file is set to "read only."
Corrective action	Connect the unit to a computer and change the file attribute or erase the file using the computer. Alternatively, format the microSD card (see <a href="#">page 46</a> ).

The Removable Disk icon does not appear when you connect the unit to the computer.	
Possible cause	The unit is not connected to the computer correctly.
Corrective action	Make sure that the USB cable is securely and correctly connected to the unit and to the computer (see <a href="#">page 54</a> ).

Possible cause	Power supplied from the computer to the unit is insufficient.
Corrective action	If the recorder is connected via a bus-powered USB hub, remove the hub, then use the included USB cable to connect the recorder directly to the computer's USB terminal. Alternatively, use a self-powered USB hub (with the power adapter). If the computer features multiple USB terminals, use a different USB terminal to connect the recorder (see <a href="#">page 54</a> ).

Possible cause	A network drive has been assigned.
Corrective action	If a network drive has been assigned, the drive letter (an alphabet letter used as the drive name) is already taken. In this case, the Removable Disk icon may not be created. Change the network drive assignment, then reconnect the unit. Consult your network administrator regarding how to reassign the network drive.

Possible cause	The connected computer does not recognize the recorder.
Corrective action	If the computer does not recognize the unit, try connecting it again. If you connect the unit to any computer other than those supported by the unit, Yamaha will not guarantee the operation of the unit (see <a href="#">page 54</a> ).

The file transfer speed (from the computer to the unit) is slow.	
Possible cause	The unit is connected to a USB1.1 terminal on the computer.
Corrective action	Connect the unit to a USB2.0 High Speed terminal.

When the unit is connected to the computer, the unit does not display the “Connected” icon.	
Possible cause	The unit is not connected to the computer correctly.
Corrective action	In some cases, the unit may not display the “Connected” icon or may not be recognized when it is connected to a computer. Disconnect the unit from the computer, then reconnect it.

The recorded audio sounds noisy.	
Possible cause	Wind noise has been recorded.
Corrective action	<p>The built-in stereo microphone is highly sensitive. Therefore, a slight breeze or breath — even a weak air conditioning breeze that hits the microphones directly — will be recorded as noise. To reduce the level of wind and other environmental noise:</p> <ul style="list-style-type: none"> <li>• Use the recorder with the wind screen (protection against wind and sibilance) attached to the built-in stereo microphones.</li> <li>• Turn on the High Pass Filter via menu item [HPF] (see <a href="#">page 21</a>).</li> <li>• Set the [MIC SENS] (microphone sensitivity) switch to [LOW].</li> </ul>

The recorded sound is distorted.	
Possible cause	The microphone sensitivity level may not be appropriately set.
Corrective action	<ul style="list-style-type: none"> <li>• Set the [MIC SENS] (microphone sensitivity) switch to [LOW]. If you still hear distortion, set the High Pass Filter to ON and attach the wind-screen to the recorder (see <a href="#">page 21</a>).</li> <li>• If the ALC function is turned off, set the recording peak limiter to ON (see <a href="#">page 21</a>).</li> </ul>

The recorded sound skips.	
Possible cause	<ul style="list-style-type: none"> <li>• The microSD card was formatted not on the recorder, but on a computer or other device.</li> <li>• The microSD card may be fragmented significantly.</li> </ul>
Corrective action	Use the recorder to format the microSD card (see <a href="#">page 46</a> ).

The date and time are displayed incorrectly.	
Corrective action	Set the correct date and time (see <a href="#">page 9</a> ).

Deleting files does not increase the amount of free space.	
Possible cause	The Recycle Bin function is turned on.
Corrective action	Empty the Recycle Bin (see <a href="#">page 44</a> ).

## FAQ

### Q: May I use a manganese battery ?

A: Do not use a manganese battery or NiCad battery. You may use an oxyride battery, but Yamaha will not guarantee the operation. (The battery life would be about the same as that of alkaline batteries.)

### Q: Why do I hear a rustling noise in the recordings?

A: A rustling noise may be recorded if you move the unit during recording, or even if you move your fingers while holding the unit when recording. If possible, try not to move the unit during recording.

### Q: How can I transfer the recordings onto tapes or MDs?

A: Use a standard audio cable (with 3.5mm mini plugs) to connect the unit to your tape recorder or MD recorder, then dub the recordings to a tape or MD.

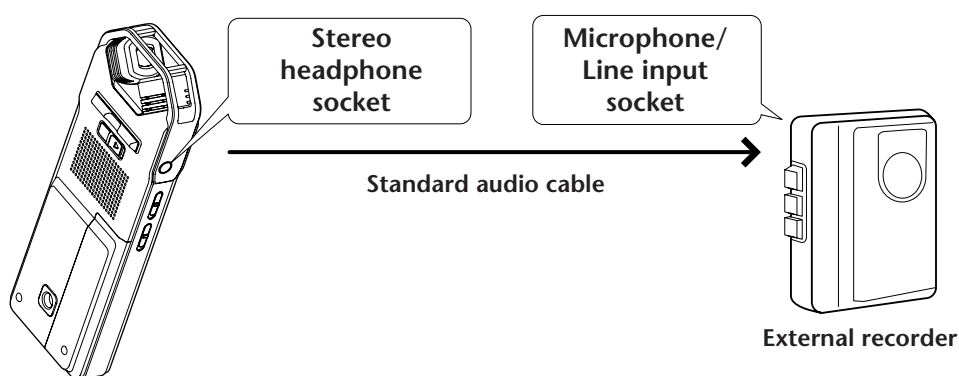

### Compatible audio cable

Socket on the external recorder	Audio cable
Microphone input	3.5-mm mini plug, with resistance
Line input	3.5-mm mini plug, without resistance

- \* Use a stereo audio cable.
- \* Before dubbing the recordings, adjust the dubbing level on the unit.
- \* You can also dub the recordings from your tape player or MD player to the unit (see [page 14](#)).

### Q: Are there any tips to making a good recording?

A: Try a test recording to set the optimum recording mode and sensitivity (see [page 10](#)), since the recording condition varies with the location and circumstances.

### Q: Does the available recording time specified in the manual apply to each file?

A: No, it refers to the available recording time on a microSD card. The available recording time in each recording mode refers to the total time available for one continuous recording without changing the recording mode, and assumes that no recorded files exist on the microSD card. Therefore, if you record one file until the microSD card is full, you cannot record further even if you change the file or folder.

**Q: I cannot play a recorded file that was stored on the computer and transferred back to the unit.**

A: You may have changed the file name on the computer. If you change the file name, the file will not play, even if it is transferred back into the VOICE or LINE folder. However, you will be able to play the file if you transfer it into the MUSIC folder.

## Specifications

Supported OS	Windows Vista, XP Professional/Home Edition
	Mac OS X 10.4, 10.5
Supported media	microSD/SDHC card
Recording mode and available recording time (with the included 2GB microSD card)	PCM 48 kHz: Approx. 2hr.50min.
	PCM 44.1 kHz: Approx. 3hr.5min.
	MP3 320 kbps: Approx. 13hr.35min.
	MP3 192 kbps: Approx. 22hr.45min.
	MP3 128 kbps: Approx. 34hr.5min.
	MP3 64 kbps: Approx. 68hr.15min.
	MP3 32 kbps: Approx. 136hr.30min.
Recording format	MP3, PCM (WAV)
Playback format	MP3 (MPEG1 LAYER3, MPEG2 LAYER3), WMA
	PCM (Only files recorded on this unit are supported.)
Frequency response (recording with an external microphone)	40–23,000Hz (PCM 48kHz, 16bit)
	40–21,000Hz (PCM 44.1kHz, 16bit)
	40–20,000Hz (MP3 320kbps)
	40–20,000Hz (MP3 192kbps)
	40–15,000Hz (MP3 128kbps)
	40–7,500Hz (MP3 64kbps)
	40–6,500Hz (MP3 32kbps)
Frequency response (recording with the built-in microphone)	60–20,000Hz (PCM recording) * The high end frequency response varies with the recording mode that was selected for recording with an external microphone. The low end response is 60Hz in all MP3 recording modes.
Frequency response (playback)	20–23,000Hz
Sampling frequency	16kHz–48kHz
Bit rate (playback)	16–320kbps (MP3)
	32–192kbps (WMA) * Some files may not be played back correctly.
Connectors	USB mini, Stereo headphones 3.5-mm mini, Stereo microphone (line input) 3.5-mm mini, microSD card slot
Operating temperature	+5°C – +35°C (+41°F – +95°F)
Output (headphones)	10mW + 10mW (at 16Ω load)
Power supply	Eneloop AA Ni-MH rechargeable battery (1) Or, "AA/LR6" alkaline battery (1)



<b>Battery life for recording (with the included 2GB microSD card)</b>	Alkaline battery: MP3 Approx. 54 hours, PCM Approx. 22 hours Eneloop: MP3 Approx. 44 hours, PCM Approx. 21.5 hours (Recording condition: Recording LED off, backlight off, no recording monitoring, ALC on)
<b>Battery life for playback through headphones (with the included 2GB microSD card)</b>	Alkaline battery: MP3 Approx. 58.5 hours, PCM Approx. 25 hours Eneloop: MP3 Approx. 48 hours, PCM Approx. 23 hours (Playback condition: Playback LED off, backlight off, no recording monitoring, FLAT sound EQ)
<b>Battery life for playback through the speaker (with the included 2GB microSD card)</b>	Alkaline battery: MP3 Approx. 38 hours, PCM Approx. 19.5 hours Eneloop: MP3 Approx. 32 hours, PCM Approx. 19.5 hours (Playback condition: Playback LED off, backlight off, no recording monitoring, FLAT sound EQ)
<b>Dimensions</b>	Approx. 46.5(W) x 129.5(H) x 17.5(D) mm
<b>Weight</b>	Approx. 91g (including "eneloop")
<b>Included accessories</b>	Eneloop AA Ni-MH rechargeable battery (1) 2GB microSD memory card (1) Earphones (1) Carrying bag (1) Microphone stand adapter (1) Windscreen (1) DVD-ROM (1) USB cable (1) Owner's Manual (1)

- Battery life varies depending on the type and manufacturer of the battery/microSD-card, storage conditions, usage, ambient temperature, etc. The battery life values listed above are estimates and are not guaranteed. Yamaha will not guarantee operation if you use any battery other than an alkaline battery or a rechargeable battery specified by Yamaha (eneloop).
- Specifications and descriptions in this owner's manual are for information purposes only. Yamaha Corp. reserves the right to change or modify products or specifications at any time without prior notice. Since specifications, equipment or options may not be the same in every locale, please check with your Yamaha dealer.

## Index

### Symbols

- ▶▶ button..... 4, 12
- ◀◀ button..... 4, 12

### A

- A-B Repeat playback ..... 31
- Alarm..... 48
- ALC (Auto Level Control) ..... 10
- ALC ON/OFF switch ..... 6
- Audio cable ..... 15, 78
- Audio files ..... 60
- Auto Divide ..... 23
- Auto Power Off ..... 52
- Available recording time ..... 16

### B

- Backlight ..... 52
- Battery cover ..... 6
- Battery setting..... 51
- Beep sound ..... 52
- Bit rate ..... 7, 16
- Built-in stereo microphone ..... 4

### C

- CD ..... 60, 62
- CD player ..... 14
- Clear Voice..... 33
- Computer ..... 54
- Contrast ..... 53
- Cubase AI ..... 67

### D

- Date ..... 9
- DEL button..... 6
- Deleting
  - Deleting a selected file..... 45
  - Deleting all data ..... 46
  - Deleting all files from a folder..... 46
- Dividing files..... 37

### E

- EDIT/PHRASE button ..... 5
- Editing Files ..... 37
- Enloop ..... 71
- EQ (equalizer)..... 18, 34
- Error messages..... 72
- External audio device ..... 14
- External microphone ..... 10

### F

- Fade in ..... 39
- Fade out ..... 39
- FAQ ..... 78
- Fast forwarding..... 28
- Fast reversing ..... 28
- File ..... 57
- File names ..... 38, 59
- Folder..... 57
- Folder structure..... 59
- FOLDER/A-B REPEAT button ..... 5, 11
- Formatting a microSD card ..... 46
- Frequency ..... 16, 18, 34

### H

- Headphones..... 28
- Headphones socket..... 6
- High Pass Filter (HPF)..... 21
- HOLD/CHARGE switch..... 6

### I

- Index marks ..... 40
- Indicators displayed during playback ..... 27
- Indicators displayed during recording..... 13
- Initializing the menu settings..... 53

### L

- LCD screen ..... 4, 7
- LED..... 5, 25
- Level meter ..... 11, 13
- Linear PCM..... 7
- List screen ..... 8
- LIST/INDEX button ..... 5, 8
- Locating the file to play back..... 28
- Locating the index..... 28

**M**

Main screen.....	8
Manual.....	3
MD .....	78
Menu.....	50
Menu item list.....	50
Menu screen.....	8
MENU/ENTER button.....	4, 8
MIC LEVEL (recording level).....	12
MIC SENS HIGH/LOW switch .....	6
MIC/LINE  socket .....	5
Microphone .....	10
Microphone sensitivity .....	10
Microphone stand (adapter) .....	6, 11
microSD card .....	6, 46
MP3 .....	7, 10, 16
Music.....	62

**P**

PCM (WAV).....	7, 10, 16
PLAY/SPEED  button.....	5
Playback .....	26
Playing back files.....	26
Playing back tracks from the Playlist....	27
Repeat playback.....	32
Using the A-B Repeat playback function.....	31
Using the Phrase playback function.....	31
Using the Skip playback function.....	30
Playback speed.....	29
Playlist.....	66
POWER button .....	5

**R**

REC/PAUSE  button.....	4
Recharging.....	71
Recording	
Recording from an external audio device (such as a CD player) .....	14
Recording musical performance .....	11
Simple recording.....	13
Recording EQ (equalizer) .....	18
Recording level.....	12
Recording mode .....	10, 16
Recording peak limiter .....	12, 21
Recycle Bin.....	42
Repeat playback .....	31, 32

**S**

Screens .....	8
Self timer.....	24
Skip playback .....	30
Sound EQ (equalizer).....	34
Sound quality .....	16
Speaker.....	6
Specifications .....	80
STANDBY mode .....	11
Stereo mini plug .....	15
Stereo wide recording .....	21
STOP/ESC  button.....	4
Sync.....	64

**T**

Threaded socket for attaching a tripod.....	6
Time .....	9
Timer recording .....	47
Tripod .....	11
Troubleshooting.....	56, 74

**U**

USB terminal .....	6, 55
USER .....	20, 36

**V**

VAS (Voice Activated System) .....	22
Version .....	53
Voice sensing level (VAS value) .....	22
VOL + / - button .....	4
Volume .....	4

**W**

Wind screen .....	10
Windows Media Player.....	60