



reface

MOBILE MINI KEYBOARD

Version 1.30 Supplementary Manual

This manual describes additions and changes with respect to the Owner's Manual that came with your instrument. It also includes Version 1.2 content for the reface CS and reface DX.

Table of Contents

New reface CS Functions.....	3
Master Tuning	3
Master Transpose	5
Pitch Bend Range	6
Transmit Channel.....	8
Receive Channel.....	9
Quantize Mode.....	11
Guide / Click Sound Switch.....	11
Foot Volume / Sustain Switch	12
Sustain (sustain-pedal selection)	12
New reface DX Functions.....	13
Master Tuning (M.TUNE)	13
Master Transpose (M.TP)	13
Quantize Mode.....	14
Guide / Click Sound Switch.....	14
New reface CP Functions.....	15
Master Tuning	15
Master Transpose	17
Transmit Channel.....	18
Receive Channel.....	19
New reface YC Functions.....	21
Master Tuning	21
Master Transpose	23
Transmit Channel.....	24
Receive Channel.....	25
Appendix	27
Keyboard Settings.....	27

New reface CS Functions

Yamaha has upgraded the reface CS firmware, adding the following new functions.

- Master Tuning
- Master Transpose
- Pitch Bend Range
- Transmit Channel
- Receive Channel
- Quantize Mode
- Guide / Click Sound Switch
- Foot Volume / Sustain Switch
- Sustain

Master Tuning

The Master Tuning function sets the tuning for the entire instrument (414.8 to 466.8 Hz).

This can be very useful when you wish to tune your reface to the pitch of another instrument or a CD.

Factory default setting: 440.0 Hz

● Setting to either 440.0 Hz or 442.0 Hz

1. While holding down the A3 key, set the [⏻] (Standby/On) switch to On (■).

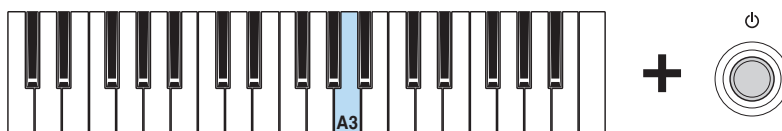

Each time you perform this operation, the master tuning will toggle between 440.0 Hz and 442.0 Hz.

Display when set

440.0 Hz	Lamps from the LOOPER section light up.
442.0 Hz	Lamps from the LOOPER section flash.

● Adjusting in 0.2-Hz steps

1. While holding down the A3, C#4, and E4 keys, set the [⏻] (Standby/On) switch to On (■). This activates Advanced Settings mode.

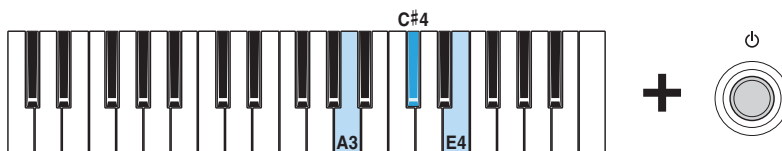

In this mode, all of the OSC [TYPE] lamps light up, and you can change parameters by using the keyboard.



- While holding down the C2 key, press a key between A#3 and C#4.
If, for example, you wish to raise the pitch by 1.00 Hz, press the C#4 key five times while holding down the C2 key.

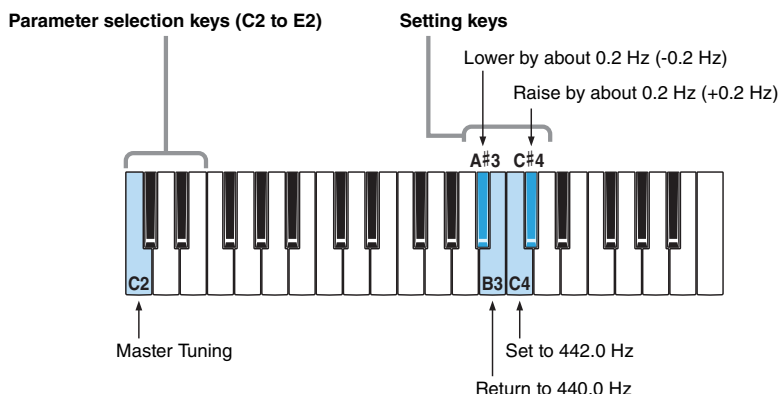

Whenever you press a parameter selection key or a setting key, the lighting condition of the OSC [TYPE] lamps changes accordingly. No sound is produced during the setting process.

- Release the C2 key and confirm that all of the OSC [TYPE] lamps light up. This indicates that your setting has been saved.

NOTICE

Do not turn off the instrument until all of the OSC [TYPE] lamps have lit up. Failure to observe this precaution can lead to data becoming corrupted.

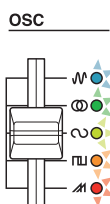

- Play a key other than the parameter selection keys (C2 to E2) to check the sound. If you need to continue adjusting, return to Step 2 above.

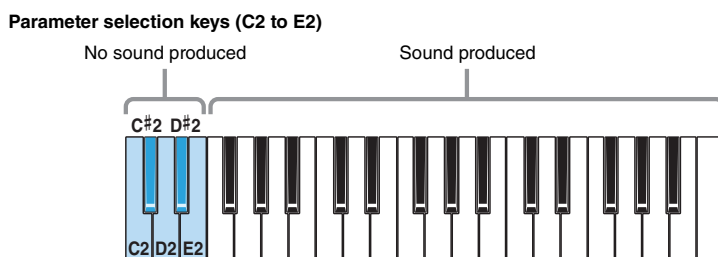

- Press the [⏻] (Standby/On) switch to turn off the instrument and exit Advanced Settings mode. In order to avoid changing other parameter settings while playing, be sure to always exit Advanced Settings mode after changing settings. Settings made in Advanced Settings mode are retained after you turn off the instrument.

Master Transpose

The Master Transpose function adjusts the sound produced by the keyboard in semitone units (where 12 semitones equals one octave).

This allows you to, for example, change the key of a song while still playing the same keys on the keyboard.

Factory default setting: 0

● Procedure

1. While holding down the A3, C#4, and E4 keys, set the [⏻] (Standby/On) switch to On (⬆). This activates Advanced Settings mode.

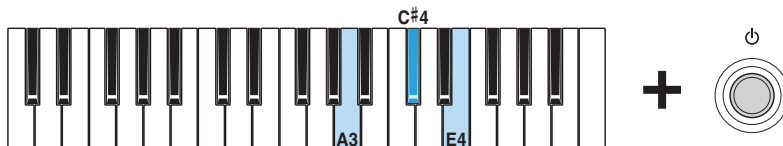

In this mode, all of the OSC [TYPE] lamps light up, and you can change parameters by using the keyboard.

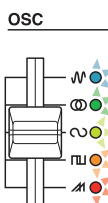

2. While holding down the D2 key, press a key between C3 and C5.

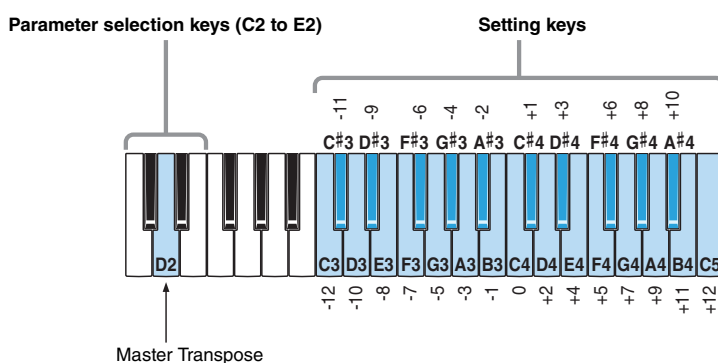

Whenever you press a parameter selection key or a setting key, the lighting condition of the OSC [TYPE] lamps changes accordingly. No sound is produced during the setting process.

3. Release the D2 key and confirm that all of the OSC [TYPE] lamps light up. This indicates that your setting has been saved.

NOTICE

Do not turn off the instrument until all of the OSC [TYPE] lamps have lit up. Failure to observe this precaution can lead to data becoming corrupted.



4. Play a key other than the parameter selection keys (C2 to E2) to check the sound. If you need to continue adjusting, return to Step 2 above.

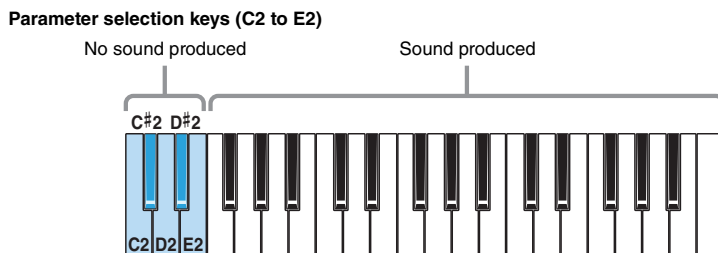

5. Press the [⏻] (Standby/On) switch to turn off the instrument and exit Advanced Settings mode. In order to avoid changing other parameter settings while playing, be sure to always exit Advanced Settings mode after changing settings. Settings made in Advanced Settings mode are retained after you turn off the instrument.

Pitch Bend Range

The Pitch Bend Range function sets, in semitone units, the range over which the pitch can be varied.

NOTE

If you wish to reverse the direction in which the pitch bends, use the Pitch-bend Range Inversion function.

Factory default setting: 12 semitones (one octave)

● **Setting to 12 semitones or two semitones**

1. While holding down the C3 key, set the [⏻] (Standby/On) switch to On (■).



Each time you perform this operation, the pitch bend range toggles between “12” and “2.”

Display when set

12	Lamps from the LOOPER section light up.
2	Lamps from the LOOPER section flash.

● Adjusting in semitone units

1. While holding down the A3, C#4, and E4 keys, set the [⏻] (Standby/On) switch to On (⬆). This activates Advanced Settings mode.

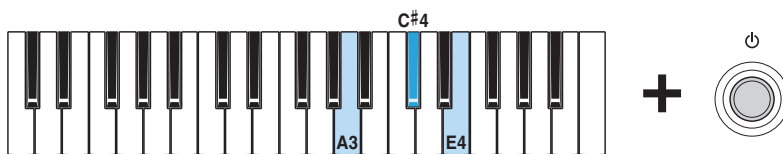

In this mode, all of the OSC [TYPE] lamps light up, and you can change parameters by using the keyboard.

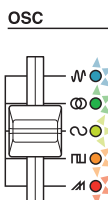

2. While holding down the E2 key, press a key between C3 and C5.

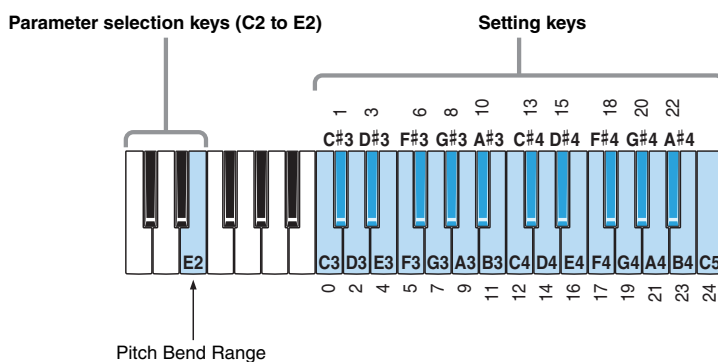

Whenever you press a parameter selection key or a setting key, the lighting condition of the OSC [TYPE] lamps changes accordingly. No sound is produced during the setting process.

3. Release the E2 key and confirm that all of the OSC [TYPE] lamps light up. This indicates that your setting has been saved.

NOTICE

Do not turn off the instrument until all of the OSC [TYPE] lamps have lit up. Failure to observe this precaution can lead to data becoming corrupted.

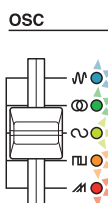

4. Play a key other than the parameter selection keys (C2 to E2) to check the sound. If you need to continue adjusting, return to Step 2 above.

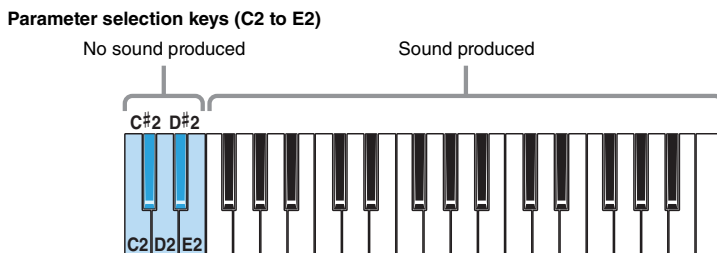

5. Press the [⏻] (Standby/On) switch to turn off the instrument and exit Advanced Settings mode. In order to avoid changing other parameter settings while playing, be sure to always exit Advanced Settings mode after changing settings. Settings made in Advanced Settings mode are retained after you turn off the instrument.

Transmit Channel

The Transmit Channel function sets the MIDI transmit channel.

Factory default setting: Channel 1

● Setting channels 1 to 16 or turning off MIDI transmit

1. While holding down the A3, C#4, and E4 keys, set the [⏻] (Standby/On) switch to On (⏻). This activates Advanced Settings mode.

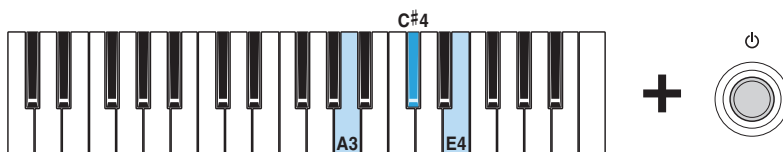

In this mode, all of the OSC [TYPE] lamps light up, and you can change parameters by using the keyboard.

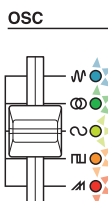

2. While holding down the C#2 key, press a key between C3 and E4.

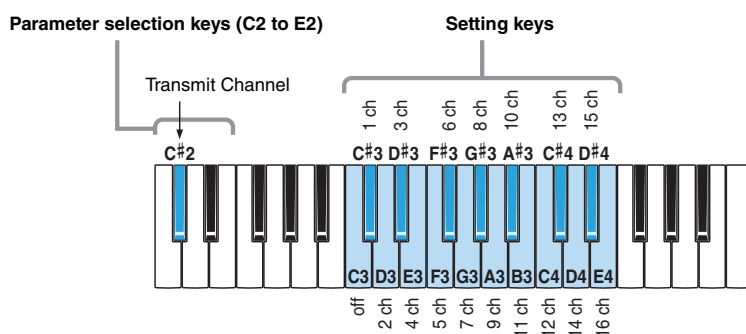

Whenever you press a parameter selection key or a setting key, the lighting condition of the OSC [TYPE] lamps changes accordingly. No sound is produced during the setting process.

- Release the C#2 key and confirm that all of the OSC [TYPE] lamps light up. This indicates that your setting has been saved.

NOTICE

Do not turn off the instrument until all of the OSC [TYPE] lamps have lit up. Failure to observe this precaution can lead to data becoming corrupted.

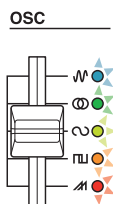

- Play a key other than the parameter selection keys (C2 to E2) to check the sound. If you need to continue adjusting, return to Step 2 above.

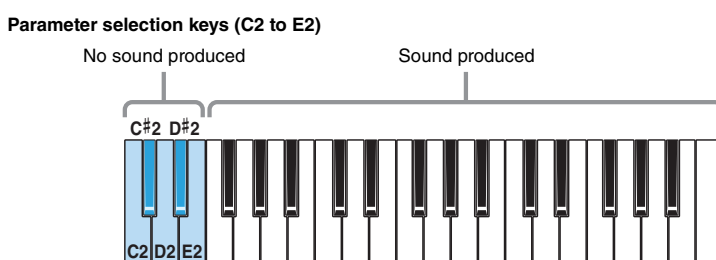

- Press the [⏻] (Standby/On) switch to turn off the instrument and exit Advanced Settings mode. In order to avoid changing other parameter settings while playing, be sure to always exit Advanced Settings mode after changing settings. Settings made in Advanced Settings mode are retained after you turn off the instrument.

Receive Channel

The Receive Channel function sets the MIDI receive channel(s).

Factory default setting: All

● Procedure

- While holding down the A3, C#4, and E4 keys, set the [⏻] (Standby/On) switch to On (⏻). This activates Advanced Settings mode.

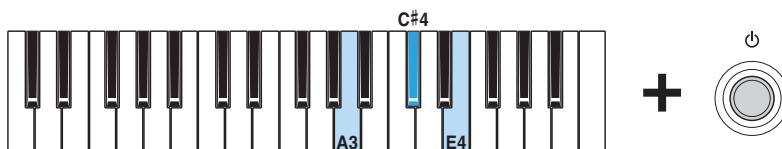

In this mode, all of the OSC [TYPE] lamps light up, and you can change parameters by using the keyboard.

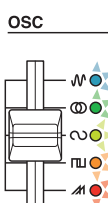

- While holding down the D#2 key, press a key between C3 and E4.

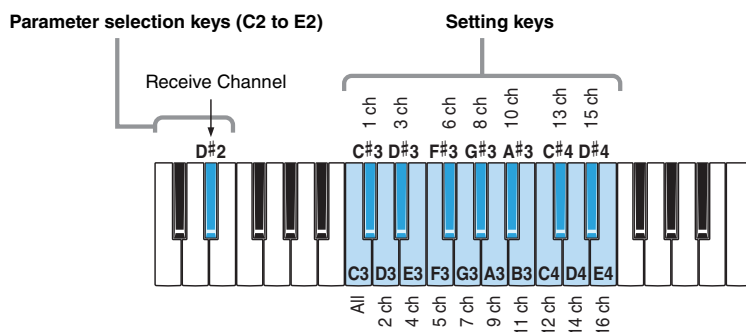

Whenever you press a parameter selection key or a setting key, the lighting condition of the OSC [TYPE] lamps changes accordingly. No sound is produced during the setting process.

- Release the D#2 key and confirm that all of the OSC [TYPE] lamps light up. This indicates that your setting has been saved.

NOTICE

Do not turn off the instrument until all of the OSC [TYPE] lamps have lit up. Failure to observe this precaution can lead to data becoming corrupted.

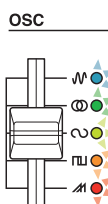

- Play a key other than the parameter selection keys (C2 to E2) to check the sound. If you need to continue adjusting, return to Step 2 above.

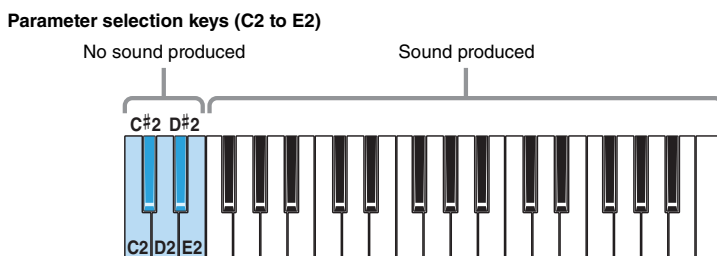

- Press the [⏻] (Standby/On) switch to turn off the instrument and exit Advanced Settings mode. In order to avoid changing other parameter settings while playing, be sure to always exit Advanced Settings mode after changing settings. Settings made in Advanced Settings mode are retained after you turn off the instrument.

Quantize Mode

Quantize mode lets you automatically quantize notes in real time as you record. Quantize aligns the timing of note events to the nearest beat. On your reface CS, you can select either sixteenth notes or eighth-note triplets as the quantize timing.

Setting Quantize mode

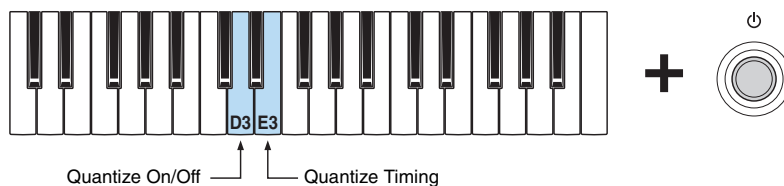

While holding down the D3 key, press the [⏻] (Standby/On) switch to toggle Quantize mode on and off. While holding down the E3 key, press the [⏻] (Standby/On) switch to toggle the quantize timing between sixteenth notes and eighth-note triplets.

Factory default setting: Quantize off
Quantize timing at sixteenth notes

Display when set

Quantize on	Lamps from the LOOPER section light up.
Quantize off	Lamps from the LOOPER section flash.
Quantize timing at sixteenth notes	Lamps from the LOOPER section light up.
Quantize timing at eighth-note triplets	Lamps from the LOOPER section flash.

Guide / Click Sound Switch

The Guide / Click Sound Switch function sets whether a guide sound or a click sound should be produced when recording loop phrases.

Factory default setting: Guide sound (the current sound)

● Procedure

1. While holding down the G3 key, set the [⏻] (Standby/On) switch to On (■).



Each time you perform this operation, the sound toggles between guide and click.

Display when set

Guide sound	Lamps from the LOOPER section light up.
Click sound	Lamps from the LOOPER section flash.

Foot Volume / Sustain Switch

The Foot Volume / Sustain Switch function sets whether Foot Volume or Sustain is to be controlled via the [FOOT CONTROLLER] jack.

Factory default setting: Foot Volume

● Procedure

1. While holding down the F3 key, set the [⏻] (Standby/On) switch to On (■).



Each time you perform this operation, the setting toggles between Foot Volume and Sustain.

Display when set

Foot Volume	Lamps from the LOOPER section light up.
Sustain	Lamps from the LOOPER section flash.

Sustain (sustain-pedal selection)

The Sustain function is used to set which sustain pedal is being used with your reface. If you have connected an FC3 foot pedal or an FC4 or FC5 foot switch, select “FC3” or “FC4/5” based on the pedal type (i.e., whether or not it supports half-damper operation), and furthermore, use the Foot Volume / Sustain Switch function to set “Sustain.”

NOTE

Half-damper playing has no effect on the sound of the reface CS.

Factory default setting: FC4/5 (an FC4 or FC5, or an FC3 without half-damper operation)

● Procedure

1. While holding down the G2 key, set the [⏻] (Standby/On) switch to On (■).



Each time you perform this operation, the setting toggles between “FC3” and “FC4/5.”

Display when set

FC4/5	Lamps from the LOOPER section light up.
FC3	Lamps from the LOOPER section flash.

New reface DX Functions

Yamaha has upgraded the reface DX firmware, adding the following new parameters.

- Master Tuning
- Master Transpose
- Quantize Mode
- Guide / Click Sound Switch

Master Tuning (M.TUNE)

Master Transpose (M.TP)

Master Tuning and Master Transpose can be set on the Tuning screen that has been added as Page 2 displayed by using the [FUNCTION] button.



M.TUNE (Master Tuning)	414.8 to 466.8 (Hz)	Shifts the pitch of the entire instrument in 0.2-Hz steps. This can be very useful when you wish to tune your reface to the pitch of another instrument or a CD.
	440.0 (Hz)	Returns the Master Tuning to the factory default setting (440.0 Hz).
M.TP (Master Transpose)	-12 to +12	Adjusts the sound produced by the keyboard in semitone units (where 12 semitones equals one octave). This allows you to, for example, change the key of a song while still playing the same keys on the keyboard.

NOTE

The MIDI Settings screen, the System Settings screen, and the Job screen can now be found on pages 3, 4, and 5, respectively.

Quantize Mode

Quantize mode lets you automatically quantize notes in real time as you record. Quantize aligns the timing of note events to the nearest beat. On your reface DX, you can select either sixteenth notes or eighth-note triplets as the quantize timing.

Factory default setting: Quantize off

● Setting Quantize mode



Quantize mode can be set on the Looper's Recording Standby screen or Playing screen. Use the "QUANT" switch to switch between off, sixteenth notes, and eighth-note triplets.

Guide / Click Sound Switch

The Guide / Click Sound Switch function sets whether a guide sound or a click sound should be produced when recording the Phrase Looper's first phrase.

1. Press the [LOOPER] button to start the Phrase Looper.
2. Tap the leftmost switch from the DATA ENTRY section to switch between "GUIDE" (guide sound), "CLICK" (click sound), and "OFF."



New reface CP Functions

Yamaha has upgraded the reface CP firmware, adding the following new functions.

- Master Tuning
- Master Transpose
- Transmit Channel
- Receive Channel

Master Tuning

The Master Tuning function sets the tuning for the entire instrument (414.8 to 466.8 Hz).

This can be very useful when you wish to tune your reface to the pitch of another instrument or a CD.

Factory default setting: 440.0 Hz

● Setting to either 440.0 Hz or 442.0 Hz

1. While holding down the A3 key, set the [⏻] (Standby/On) switch to On (⬆).

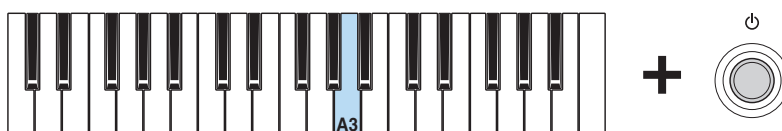

Each time you perform this operation, the master tuning will toggle between 440.0 Hz and 442.0 Hz.

Display when set

440.0 Hz	The [TYPE] knob's Clv lamp and the lamps from the TREMOLO/WAH to D.DELAY/A.DELAY sections light up.
442.0 Hz	The [TYPE] knob's Clv lamp and the lamps from the TREMOLO/WAH to D.DELAY/A.DELAY sections flash.

● Adjusting in 0.2-Hz steps

1. While holding down the A3, C#4, and E4 keys, set the [⏻] (Standby/On) switch to On (⬆). This activates Advanced Settings mode.

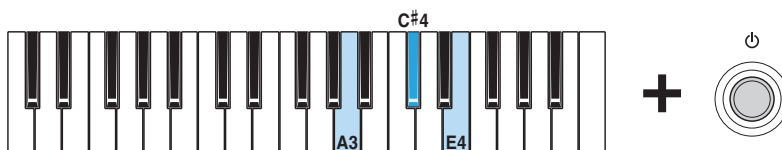

In this mode, all of the [TYPE] lamps light up, and you can change parameters by using the keyboard.

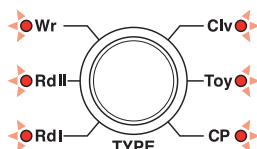

2. While holding down the C2 key, press a key between A#3 and C#4.
If, for example, you wish to raise the pitch by 1.00 Hz, press the C#4 key five times while holding down the C2 key.

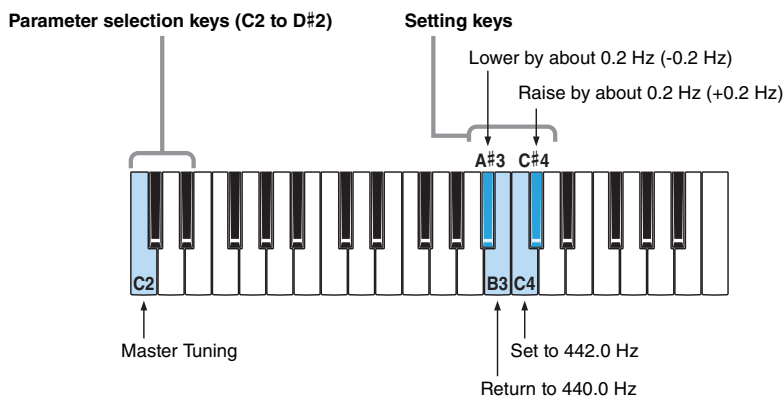

Whenever you press a parameter selection key or a setting key, the lighting condition of the [TYPE] lamps changes accordingly. No sound is produced during the setting process.

3. Release the C2 key and confirm that all of the [TYPE] lamps light up.
This indicates that your setting has been saved.

NOTICE

Do not turn off the instrument until all of the [TYPE] lamps have lit up. Failure to observe this precaution can lead to data becoming corrupted.

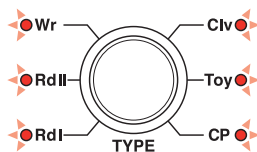

4. Play a key other than the parameter selection keys (C2 to D#2) to check the sound. If you need to continue adjusting, return to Step 2 above.

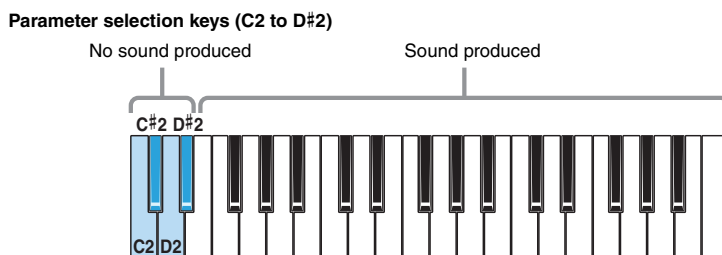

5. Press the [⏻] (Standby/On) switch to turn off the instrument and exit Advanced Settings mode.
In order to avoid changing other parameter settings while playing, be sure to always exit Advanced Settings mode after changing settings.
Settings made in Advanced Settings mode are retained after you turn off the instrument.

Master Transpose

The Master Transpose function adjusts the sound produced by the keyboard in semitone units (where 12 semitones equals one octave).

This allows you to, for example, change the key of a song while still playing the same keys on the keyboard.

Factory default setting: 0

● Procedure

1. While holding down the A3, C#4, and E4 keys, set the [⏻] (Standby/On) switch to On (⬇️). This activates Advanced Settings mode.

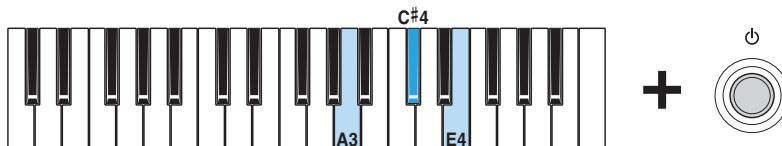

In this mode, all of the [TYPE] lamps light up, and you can change parameters by using the keyboard.

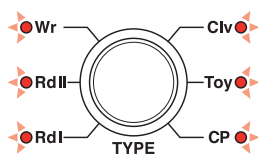

2. While holding down the D2 key, press a key between C3 and C5.

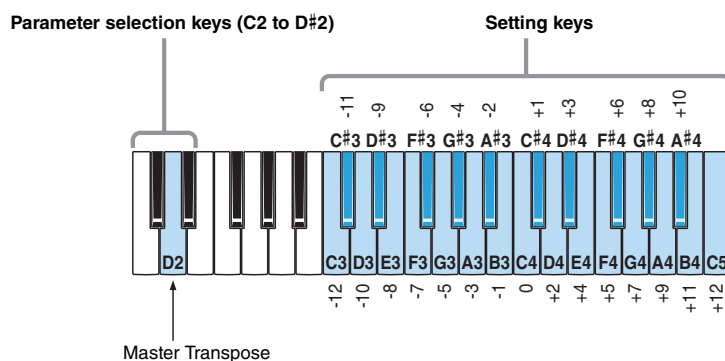

Whenever you press a parameter selection key or a setting key, the lighting condition of the [TYPE] lamps changes accordingly. No sound is produced during the setting process.

3. Release the D2 key and confirm that all of the [TYPE] lamps light up. This indicates that your setting has been saved.

NOTICE

Do not turn off the instrument until all of the [TYPE] lamps have lit up. Failure to observe this precaution can lead to data becoming corrupted.

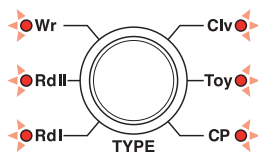

4. Play a key other than the parameter selection keys (C2 to D#2) to check the sound. If you need to continue adjusting, return to Step 2 above.

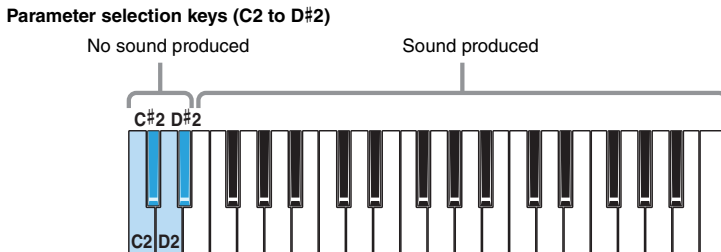

5. Press the [⏻] (Standby/On) switch to turn off the instrument and exit Advanced Settings mode. In order to avoid changing other parameter settings while playing, be sure to always exit Advanced Settings mode after changing settings. Settings made in Advanced Settings mode are retained after you turn off the instrument.

Transmit Channel

The Transmit Channel function sets the MIDI transmit channel.

Factory default setting: Channel 1

● Procedure

1. While holding down the A3, C#4, and E4 keys, set the [⏻] (Standby/On) switch to On (⏻). This activates Advanced Settings mode.

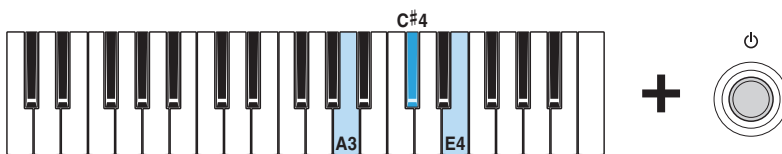

In this mode, all of the [TYPE] lamps light up, and you can change parameters by using the keyboard.

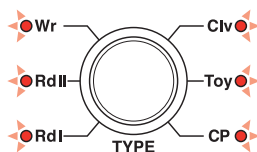

2. While holding down the C#2 key, press a key between C3 and E4.

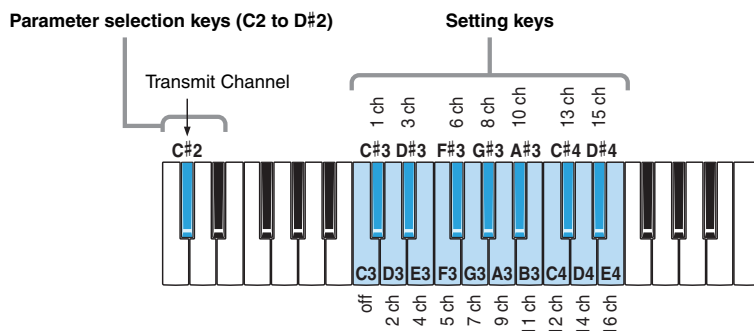

Whenever you press a parameter selection key or a setting key, the lighting condition of the [TYPE] lamps changes accordingly. No sound is produced during the setting process.

- Release the C#2 key and confirm that all of the [TYPE] lamps light up. This indicates that your setting has been saved.

NOTICE

Do not turn off the instrument until all of the [TYPE] lamps have lit up. Failure to observe this precaution can lead to data becoming corrupted.

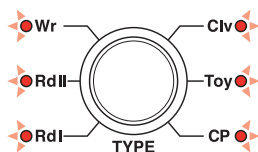

- Play a key other than the parameter selection keys (C2 to D#2) to check the sound. If you need to continue adjusting, return to Step 2 above.

Parameter selection keys (C2 to D#2)

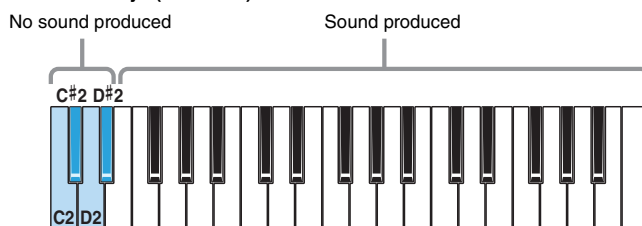

- Press the [⏻] (Standby/On) switch to turn off the instrument and exit Advanced Settings mode. In order to avoid changing other parameter settings while playing, be sure to always exit Advanced Settings mode after changing settings. Settings made in Advanced Settings mode are retained after you turn off the instrument.

Receive Channel

The Receive Channel function sets the MIDI receive channel(s).

Factory default setting: All

● Procedure

- While holding down the A3, C#4, and E4 keys, set the [⏻] (Standby/On) switch to On (⏻). This activates Advanced Settings mode.

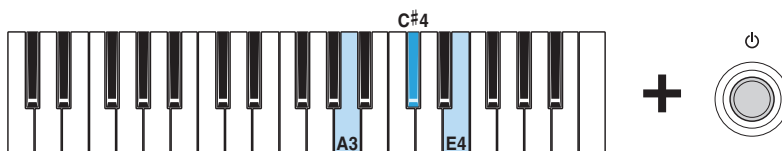

In this mode, all of the [TYPE] lamps light up, and you can change parameters by using the keyboard.

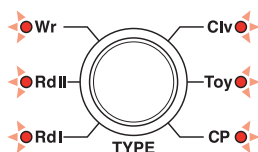

- While holding down the D#2 key, press a key between C3 and E4.

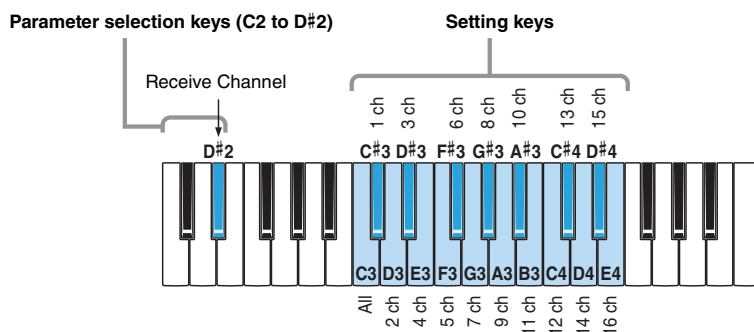

Whenever you press a parameter selection key or a setting key, the lighting condition of the [TYPE] lamps changes accordingly. No sound is produced during the setting process.

- Release the D#2 key and confirm that all of the [TYPE] lamps light up. This indicates that your setting has been saved.

NOTICE

Do not turn off the instrument until all of the [TYPE] lamps have lit up. Failure to observe this precaution can lead to data becoming corrupted.

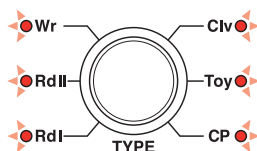

- Play a key other than the parameter selection keys (C2 to D#2) to check the sound. If you need to continue adjusting, return to Step 2 above.

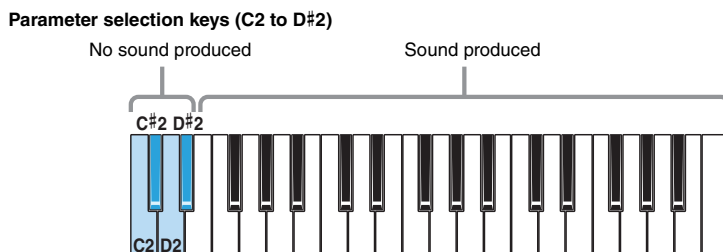

- Press the [⏻] (Standby/On) switch to turn off the instrument and exit Advanced Settings mode. In order to avoid changing other parameter settings while playing, be sure to always exit Advanced Settings mode after changing settings. Settings made in Advanced Settings mode are retained after you turn off the instrument.

New reface YC Functions

Yamaha has upgraded the reface YC firmware, adding the following new functions.

- Master Tuning
- Master Transpose
- Transmit Channel
- Receive Channel

In addition, when the rotary speed is FAST, you can now also switch to SLOW by moving the [ROTARY SPEED] lever up once.

Master Tuning

The Master Tuning function sets the tuning for the entire instrument (414.8 to 466.8 Hz).

This can be very useful when you wish to tune your reface to the pitch of another instrument or a CD.

Factory default setting: 440.0 Hz

● Setting to either 440.0 Hz or 442.0 Hz

1. While holding down the A3 key, set the [⏻] (Standby/On) switch to On (⬆).

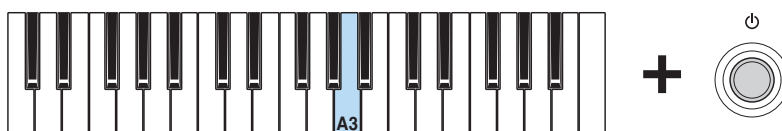

Each time you perform this operation, the master tuning will toggle between 440.0 Hz and 442.0 Hz.

Display when set

440.0 Hz	The ROTARY SPEED lamps light up.
442.0 Hz	The ROTARY SPEED lamps flash.

● Adjusting in 0.2-Hz steps

1. While holding down the A3, C#4, and E4 keys, set the [⏻] (Standby/On) switch to On (⬆). This activates Advanced Settings mode.

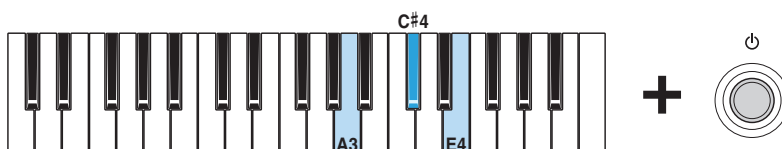

In this mode, all of the [WAVE] lamps light up, and you can change parameters by using the keyboard.

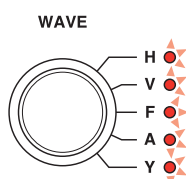

- While holding down the C2 key, press a key between A#3 and C#4.
If, for example, you wish to raise the pitch by 1.00 Hz, press the C#4 key five times while holding down the C2 key.

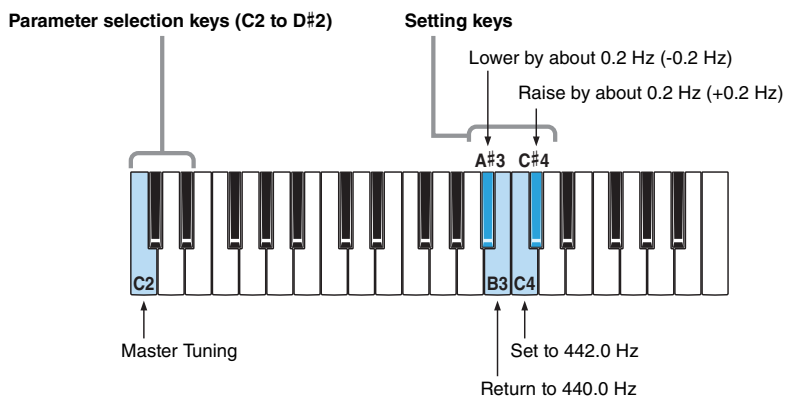

Whenever you press a parameter selection key or a setting key, the lighting condition of the [WAVE] lamps changes accordingly. No sound is produced during the setting process.

- Release the C2 key and confirm that all of the [WAVE] lamps light up. This indicates that your setting has been saved.

NOTICE

Do not turn off the instrument until all of the [WAVE] lamps have lit up. Failure to observe this precaution can lead to data becoming corrupted.

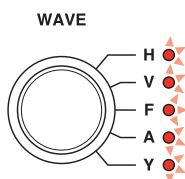

- Play a key other than the parameter selection keys (C2 to D#2) to check the sound. If you need to continue adjusting, return to Step 2 above.

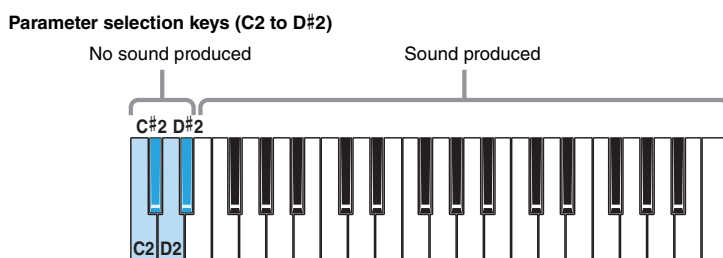

- Press the [⏻] (Standby/On) switch to turn off the instrument and exit Advanced Settings mode. In order to avoid changing other parameter settings while playing, be sure to always exit Advanced Settings mode after changing settings. Settings made in Advanced Settings mode are retained after you turn off the instrument.

4. Play a key other than the parameter selection keys (C2 to D#2) to check the sound. If you need to continue adjusting, return to Step 2 above.

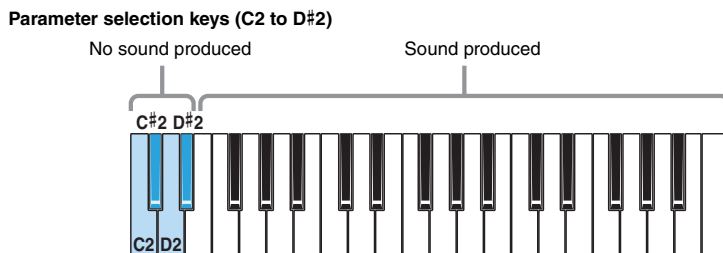

5. Press the [⏻] (Standby/On) switch to turn off the instrument and exit Advanced Settings mode. In order to avoid changing other parameter settings while playing, be sure to always exit Advanced Settings mode after changing settings. Settings made in Advanced Settings mode are retained after you turn off the instrument.

Transmit Channel

The Transmit Channel function sets the MIDI transmit channel.

Factory default setting: Channel 1

● Procedure

1. While holding down the A3, C#4, and E4 keys, set the [⏻] (Standby/On) switch to On (⏻). This activates Advanced Settings mode.

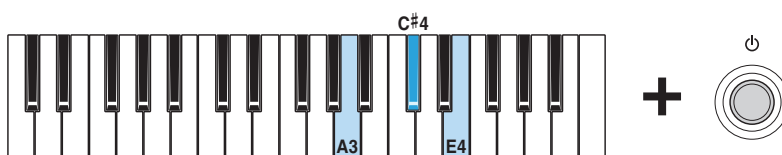

In this mode, all of the [WAVE] lamps light up, and you can change parameters by using the keyboard.

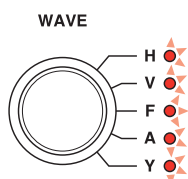

2. While holding down the C#2 key, press a key between C3 and E4.

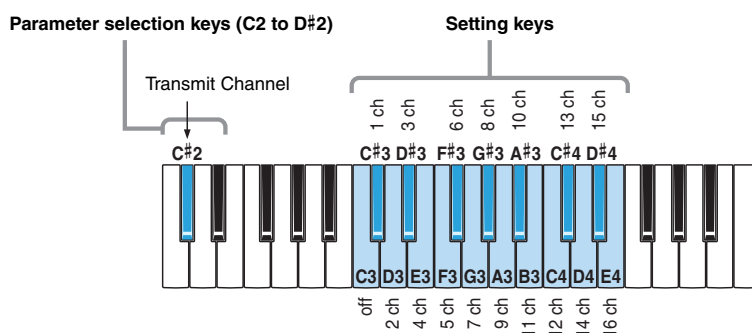

Whenever you press a parameter selection key or a setting key, the lighting condition of the [WAVE] lamps changes accordingly. No sound is produced during the setting process.

- Release the C#2 key and confirm that all of the [WAVE] lamps light up. This indicates that your setting has been saved.

NOTICE

Do not turn off the instrument until all of the [WAVE] lamps have lit up. Failure to observe this precaution can lead to data becoming corrupted.

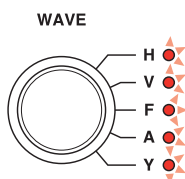

- Play a key other than the parameter selection keys (C2 to D#2) to check the sound. If you need to continue adjusting, return to Step 2 above.

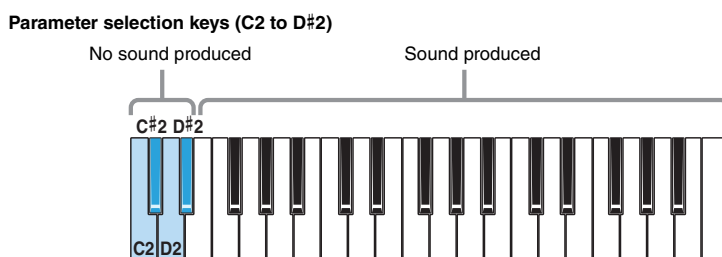

- Press the [⏻] (Standby/On) switch to turn off the instrument and exit Advanced Settings mode. In order to avoid changing other parameter settings while playing, be sure to always exit Advanced Settings mode after changing settings. Settings made in Advanced Settings mode are retained after you turn off the instrument.

Receive Channel

The Receive Channel function sets the MIDI receive channel(s).

Factory default setting: All

● Procedure

- While holding down the A3, C#4, and E4 keys, set the [⏻] (Standby/On) switch to On (⬆️). This activates Advanced Settings mode.

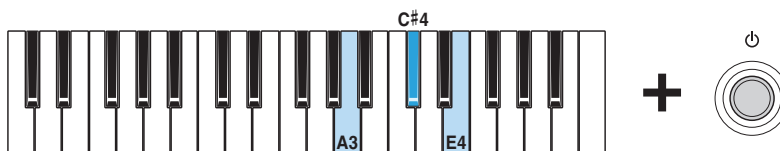

In this mode, all of the [WAVE] lamps light up, and you can change parameters by using the keyboard.

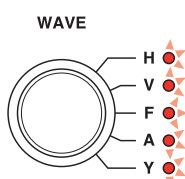

- While holding down the D#2 key, press a key between C3 and E4.

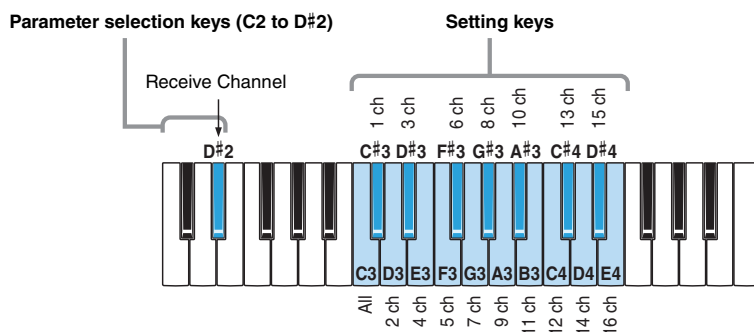

Whenever you press a parameter selection key or a setting key, the lighting condition of the [WAVE] lamps changes accordingly. No sound is produced during the setting process.

- Release the D#2 key and confirm that all of the [WAVE] lamps light up. This indicates that your setting has been saved.

NOTICE

Do not turn off the instrument until all of the [WAVE] lamps have lit up. Failure to observe this precaution can lead to data becoming corrupted.

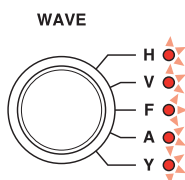

- Play a key other than the parameter selection keys (C2 to D#2) to check the sound. If you need to continue adjusting, return to Step 2 above.

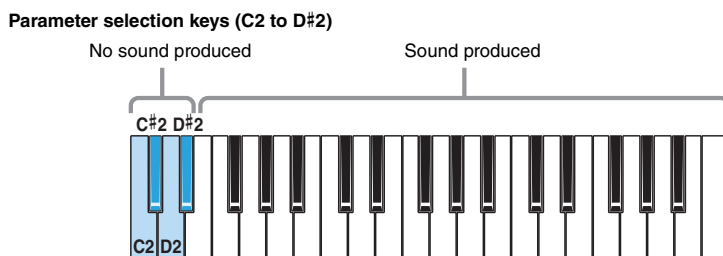

- Press the [⏻] (Standby/On) switch to turn off the instrument and exit Advanced Settings mode. In order to avoid changing other parameter settings while playing, be sure to always exit Advanced Settings mode after changing settings. Settings made in Advanced Settings mode are retained after you turn off the instrument.

Appendix

Keyboard Settings

Various settings can be made by pressing the [⏻] (Standby/On) switch while holding down a specific key on the keyboard.

If the instrument is turned on, you will need to turn it off once to make settings in this way.

Each setting is toggled on and off, etc. whenever this procedure is carried out. However, when you have set the Auto Power-Off function to off (disabled), you will need to do a Factory Reset in order to turn in back on (enabled).

Keyboard settings are retained when the instrument is turned off.

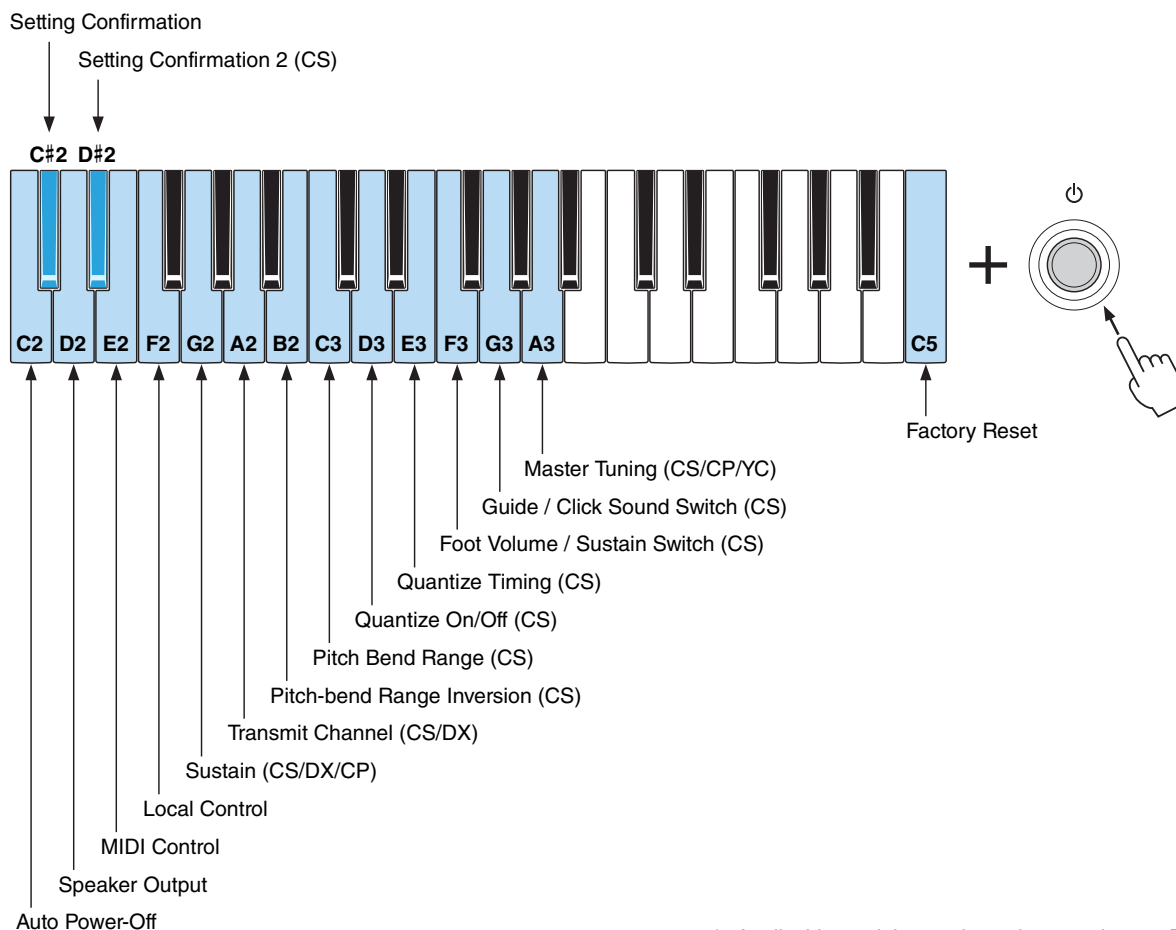

*: Applicable models are shown in parentheses. Parameters with no parentheses apply to all models.

On the reface DX, these settings can also be made by using the [FUNCTION] button. For details, refer to “Functions of Front Panel Components” for the reface DX in the Owner’s Manual.

● Setting Confirmation

For confirming the current settings of all parameters set by using the keyboard.

Display when confirming

